

DELTA H - DELTA V

kolomradiatoren

technische fiche



toebehoren

meegeleverd en inbegrepen in de prijs : ophangingen, 1 ontluchter, 1 blindstop, schroeven en pluggen.

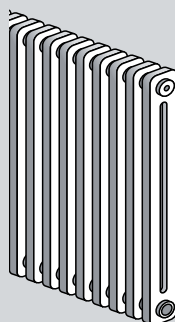

2-kolommen
63 mm

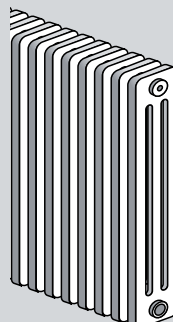

3-kolommen
101 mm

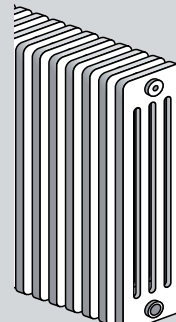

4-kolommen
139 mm



Delta H



Delta V



Delta H - standaard assortiment

elementen	lengte	hoogte								
		2 kolom					3 kolom			
		400	500	600	750	900	400	500	600	
10	500	REF.	S1-2040/10	S1-2050/10	S1-2060/10	S1-2075/10	S1-2090/10	S1-3040/10	S1-3050/10	S1-3060/10
		75/65/20	326	399	470	577	682	455	554	651
12	600	REF.	S1-2040/12	S1-2050/12	S1-2060/12	S1-2075/12	S1-2090/12	S1-3040/12	S1-3050/12	S1-3060/12
		75/65/20	391	479	564	692	818	546	665	781
14	700	REF.	S1-2040/14	S1-2050/14	S1-2060/14	S1-2075/14	S1-2090/14	S1-3040/14	S1-3050/14	S1-3060/14
		75/65/20	456	559	658	808	955	637	776	911
16	800	REF.	S1-2040/16	S1-2050/16	S1-2060/16	S1-2075/16	S1-2090/16	S1-3040/16	S1-3050/16	S1-3060/16
		75/65/20	522	638	752	923	1091	728	886	1042
18	900	REF.	S1-2040/18	S1-2050/18	S1-2060/18	S1-2075/18	S1-2090/18	S1-3040/18	S1-3050/18	S1-3060/18
		75/65/20	587	718	846	1039	1228	819	997	1172
20	1000	REF.	S1-2040/20	S1-2050/20	S1-2060/20	S1-2075/20	S1-2090/20	S1-3040/20	S1-3050/20	S1-3060/20
		75/65/20	652	798	940	1154	1364	910	1108	1302
22	1100	REF.	S1-2040/22	S1-2050/22	S1-2060/22	S1-2075/22	S1-2090/22	S1-3040/22	S1-3050/22	S1-3060/22
		75/65/20	717	878	1034	1269	1500	1001	1219	1432
24	1200	REF.	S1-2040/24	S1-2050/24	S1-2060/24	S1-2075/24	S1-2090/24	S1-3040/24	S1-3050/24	S1-3060/24
		75/65/20	782	958	1128	1385	1637	1092	1330	1562
26	1300	REF.	S1-2040/26	S1-2050/26	S1-2060/26	S1-2075/26	S1-2090/26	S1-3040/26	S1-3050/26	S1-3060/26
		75/65/20	848	1037	1222	1500	1773	1183	1440	1693
28	1400	REF.	S1-2040/28	S1-2050/28	S1-2060/28	S1-2075/28	S1-2090/28	S1-3040/28	S1-3050/28	S1-3060/28
		75/65/20	913	1117	1316	1616	1910	1274	1551	1823

afgifte gemeten volgens EN 442

 voorraad Radson

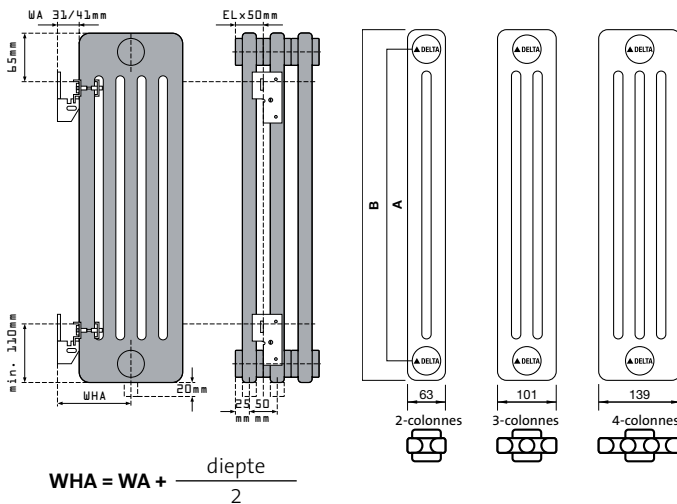

buisprofiel

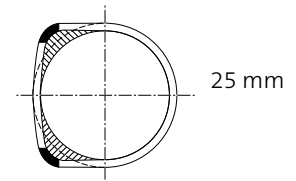

Andere aansluitingsmogelijkheden, kleuren en andere maatvoeringen : zie maatwerk prijslijst.

kenmerken

lengte element	50 mm
buisafmetingen	25 x 1,25 mm
werkdruk	10 bar
proefdruk	13 bar
max. werkteemperatuur	120 °C

hoogte	hartafstand aansluiting
B	A
400	335
500	435
600	535
750	685
900	835

montageset

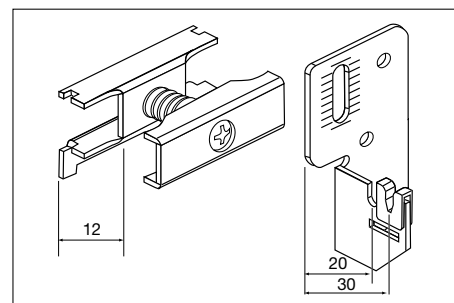

Wandafstand & hartafstand aansluiting tot de muur, voor standaard consolesets.

model	bouwdiepte	wandafstand WA
2-kolommen	63	31 / 41
3-kolommen	101	31 / 41
4-kolommen	139	31 / 41

[100 % LASER]

Delta H - standaard assortiment

elementen.	lengte	hoogte							
		3 kolom		4 kolom					
		750	900	400	500	600	750	900	
10	500	REF. 75/65/20	S1-3075/10 794	S1-3090/10 936	S1-4040/10 584	S1-4050/10 709	S1-4060/10 831	S1-4075/10 1012	S1-4090/10 1189
12	600	REF. 75/65/20	S1-3075/12 953	S1-3090/12 1123	S1-4040/12 701	S1-4050/12 851	S1-4060/12 997	S1-4075/12 1214	S1-4090/12 1427
14	700	REF. 75/65/20	S1-3075/14 1112	S1-3090/14 1310	S1-4040/14 818	S1-4050/14 993	S1-4060/14 1163	S1-4075/14 1417	S1-4090/14 1665
16	800	REF. 75/65/20	S1-3075/16 1270	S1-3090/16 1498	S1-4040/16 934	S1-4050/16 1134	S1-4060/16 1330	S1-4075/16 1619	S1-4090/16 1902
18	900	REF. 75/65/20	S1-3075/18 1429	S1-3090/18 1685	S1-4040/18 1051	S1-4050/18 1276	S1-4060/18 1496	S1-4075/18 1822	S1-4090/18 2140
20	1000	REF. 75/65/20	S1-3075/20 1588	S1-3090/20 1872	S1-4040/20 1168	S1-4050/20 1418	S1-4060/20 1662	S1-4075/20 2024	S1-4090/20 2378
22	1100	REF. 75/65/20	S1-3075/22 1747	S1-3090/22 2059	S1-4040/22 1285	S1-4050/22 1560	S1-4060/22 1828	S1-4075/22 2226	S1-4090/22 2616
24	1200	REF. 75/65/20	S1-3075/24 1906	S1-3090/24 2246	S1-4040/24 1402	S1-4050/24 1702	S1-4060/24 1994	S1-4075/24 2429	S1-4090/24 2854
26	1300	REF. 75/65/20	S1-3075/26 2064	S1-3090/26 2434	S1-4040/26 1518	S1-4050/26 1843	S1-4060/26 2161	S1-4075/26 2631	
28	1400	REF. 75/65/20	S1-3075/28 2223	S1-3090/28 2621	S1-4040/28 1635	S1-4050/28 1985	S1-4060/28 2327	S1-4075/28 2834	

afgiftes gemeten volgens EN 442 voorraad Radson

aansluitingen - hoogtes 400 tot 900 mm

4 x Ø 1/2" (15/21)

1 = blindstop
2 = ontlufter

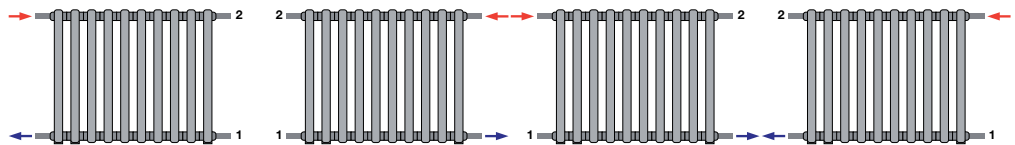

Delta V - standaard assortiment

elementen	lengte	hoogte				
		2 kolom		3 kolom		
		1800	2000	1800	2000	
8	400	REF. 75/65/20	S1-2200/8 1174			
10	500	REF. 75/65/20	S1-2180/10 1322	S1-2200/10 1468	S1-3180/10 1780	S1-3200/10 1971
12	600	REF. 75/65/20	S1-2180/12 1586	S1-2200/12 1762	S1-3180/12 2136	S1-3200/12 2365
14	700	REF. 75/65/20	S1-2180/14 1851	S1-2200/14 2055	S1-3180/14 2492	S1-3200/14 2759
16	800	REF. 75/65/20	S1-2180/16 2115	S1-2200/16 2349	S1-3180/16 2848	S1-3200/16 3154
18	900	REF. 75/65/20	S1-2180/18 2380	S1-2200/18 2642	S1-3180/18 3204	S1-3200/18 3548

afgiftes gemeten volgens EN 442 voorraad Radson

aansluitingen hoogtes 1800 tot 2000 mm

middenaansluiting : 2 x Ø 1/2" (15/21)

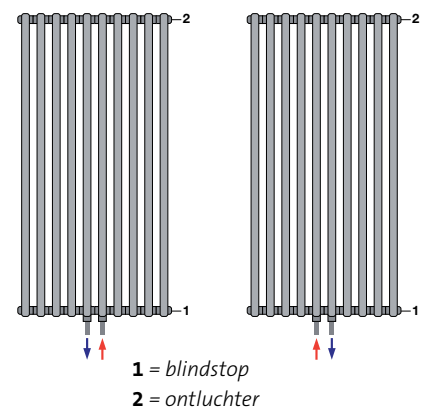

1 = blindstop
2 = ontlufter

DELTA H - DELTA V

kolomradiatoren

lastenboek

Merk	RADSON
Type	DELTA
Materiaal	staal - wanddikte 1,25 mm diameter van de buis: 25 mm
Waterregime	aanvoer: 75°C, retour: 65°C, omgeving: 20°C Warm water tot max. 120°C
Maximale werkdruk	10 bar
Maximale proefdruk	13 bar
Standaardkleur	RAL 9016

technische omschrijving

De radiatoren bestaan uit staal, volledig met de laser gelast. De buisprofielen en collectoren zijn gelast om kolommen en blokken te vormen. Voor toepassing in een centraal verwarmingssysteem, volgens DIN 4751.

De DELTA LASERLINE is beschikbaar in warmwaterversie.

esthetiek

Een elegante radiator met vlakke warmte-elementen geplaatst op de collectoren.

behandeling en afwerking

Behandelingsprocedure:

- Voorbereidingsfase
- aanbrengen van de grondverf door elektroforese
- eindlaklaag volgens in poeder

kleur

De standaardtint is RAL 9016. Andere tinten leverbaar volgens de Radson-kleurenkaart.

montage

Grote keuze aan muurbevestigingen en voeten.

aansluitingen

4 x Ø 1/2" (15/21) Andere aansluitingen mogelijk.

verpakking en bescherming

De radiatoren worden individueel verpakt in kartonnen doos met kartonnen hoekbeschermers. Het geheel is verpakt in krimpfolie.

normen

De emissies van de radiatoren, uitgedrukt in Watt, zijn opgemeten volgens de norm EN 442.

De aanvoertemperatuur bedraagt 75°C.

De retourtemperatuur bedraagt 65°C.

De omgevingstemperatuur bedraagt 20°C.

garantie

Garantie tegen fabricagefouten: 10 jaar na installatie.