





# STAAL RADIATOREN

**Vasco staalradiatoren** verenigen een optimaal eigentijds warmtecomfort met een doordachte, tijdloze vormgeving.

Elke collectie is een unieke demonstratie van warmte op haar efficiëntst én op haar mooist.

**Op maat van elke woonruimte.**

Geschikt voor elke toepassing. Stuk voor stuk meesterwerkjes van technisch vernuft en creativiteit, bekroond met vele internationale designprijzen.

Ervaren technici, innovatieve ontwerpers en wetenschappelijke specialisten creëren samen oplossingen waarin de details het verschil maken.

Staalradiatoren die zich steeds weer onderscheiden door hun zuivere vormgeving en gebruiksgemak.

## ARCHE VERTICAAL (VV)

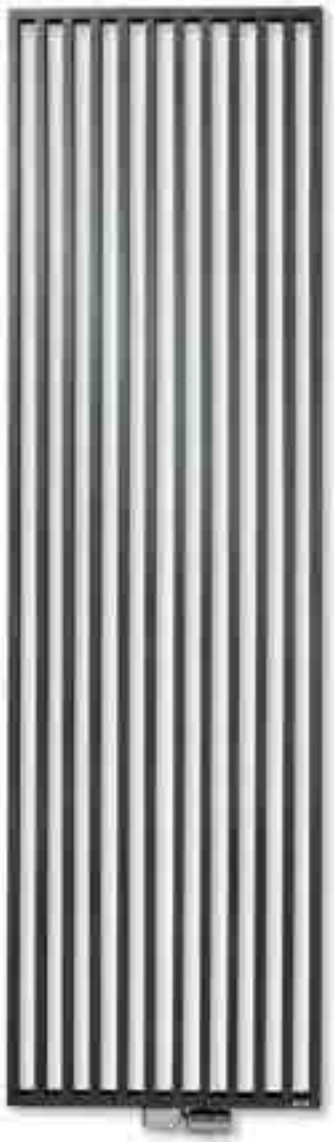

### BUIZEN

- VV: Verticaal, rechthoekig 45 x 20 mm

### KLEUREN

- Standaardkleur wit RAL 9016
- Niet verkrijgbaar in kleuren Gloss White en Jet Black
- Uitgebreide kleurenkaart zie p. 16

### SPECIAAL

- De Arche is bekroond met Design Plus Award 2005, Reddot Design Award 2006, Silver Award Designpreis Deutschland 2006 en genomineerd voor de Henry van de Velde prijs 2005.

### BEVESTIGINGEN

- Muurbevestigingen standaard

### TECHNISCH

- KTL-grondlaag, poedercoating
- Standaardwerkdruk: 4 bar
- Maximale bedrijfstemperatuur: 110°C

### ELEKTRISCH (zie hoofdstuk elektrische radiatoren)

- ✗ Zuiver elektrische radiator in de fabriek vorgevuld
- ✗ Gemengde radiator

### TECHNISCHE TEKENINGEN

- Zie p. 51

### AANSLUITING

- ✗ Eénpuntsaansluiting voor éénpijpsysteem
- ✗ Eénpuntsaansluiting voor tweepijpsysteem
- ✓ Tweepuntsaansluiting voor éénpijpsysteem (aansluiting via de middenaansluiting) (zie p. 300)
- ✓ Tweepuntsaansluiting voor tweepijpsysteem (standaard) (zie p. 300)
- ✗ Geïntegreerd ventiel

### OVER ARCHE VERTICAAL

#### Techniek en esthetiek naadloos verenigd

Een designradiatorconcept, enig in zijn soort. De buizen zijn niet op, maar in elkaar gemonteerd en vormen samen één naadloze, vlakke structuur. Ook de accessoires zijn mooi in het geheel geïntegreerd. Die perfecte verstandhouding tussen techniek en esthetiek leveren een uniek product op dat inmiddels zowat alle belangrijke designprijzen heeft weggekaapt en ook beschikbaar is in een badkameruitvoering met middenaansluiting.

### AANBEVOLEN AANSLUITING (1188)

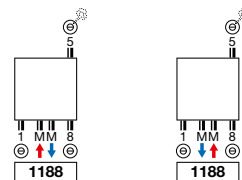

#### Andere aansluitmogelijkheden, zie p. 50

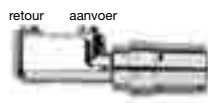

art. nr. 11821030000099  
**prijs € 155**  
Koppelingen, zie p. 313

### AANBEVOLEN VOOR BADKAMER IN OPTIE



handdoekbeugel (chrom) art. nr. 11832280000099  
**prijs € 166**

#### Andere accessoires, zie p. 50



### HOE ARCHE VERTICAAL BESTELLEN

Leveringstermijn 15 - 30 werkdagen  
(zonder transportduur)

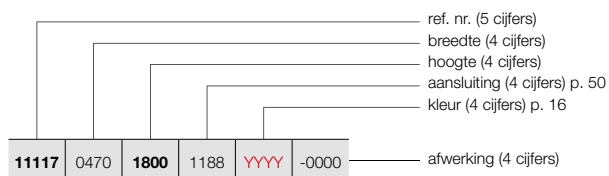

11117	0470	1800	1188	YYYY	-0000
-------	------	------	------	------	-------

### ARCHE VERTICAAL (W)



W

### HOE VOORRAADRADIATOR ARCHE VERTICAAL BESTELLEN

Leveringstermijn 5 werkdagen  
(zonder transportduur)

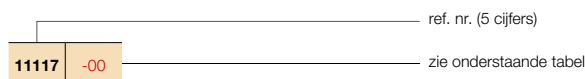

11117	-00
-------	-----

BESTELCODE MAATWERK ARCHE VERTICAAL	TECHNISCHE GEGEVENS									STANDAARDKLEUR		ANDERE KLEUREN					
	buizen	breedte (L mm)	hoogte (H mm)	75/65/20 (Watt)	55/45/20 (Watt)	n-exp.	gewicht (kg)	inhoud (l)	el. weerst. (Watt)	prijs RAL 9016	verkorte ref. nr. RAL 9016 voorraad	prijs kleur					
<b>REF. NR. ARCHE VERTICAAL W : 11117</b>																	
11117	0470	1800	1188	YYYY	-0000	10	470	1800	1050	560	1,23	22,90	13,94	-	379	11117-03	436
		2000				10	470	2000	1164	618	1,24	25,36	15,42	-	405	-	466
		2200				10	470	2200	1279	679	1,24	27,81	16,91	-	427	-	491
11117	0570	1800	1188	YYYY	-0000	12	570	1800	1273	679	1,23	27,78	16,90	-	459	11117-06	528
		2000				12	570	2000	1412	749	1,24	30,76	18,70	-	490	-	564
		2200				12	570	2200	1552	824	1,24	33,73	20,50	-	517	-	595
11117	0670	1800	1188	YYYY	-0000	14	670	1800	1496	798	1,23	32,65	19,87	-	540	-	621
		2000				14	670	2000	1660	881	1,24	36,15	21,98	-	577	-	664
		2200				14	670	2200	1824	968	1,24	39,65	24,10	-	608	-	699

CE07 conform EN442-1: radiatoren en convectoren

Voor de warmteafgiftes van andere regimes, kijkt u op p. 308 (correctiefactoren)  
 Prijzen in euro (excl. BTW)

## ARCHE PLUS VERTICAAL (VVL, VWR)



### TYPES

- VWR (beugel rechts), VVL (beugel links)

### BUIZEN

- Verticaal, rechthoekig 45 x 20 mm

### KLEUREN

- Standaardkleur wit RAL 9016
- Niet verkrijgbaar in kleuren Gloss White en Jet Black
- Uitgebreide kleurenkaart zie p. 16

### SPECIAAL

- Vaste handdoekbeugel in de kleur van de radiator
- Opgelet: deze beugel wordt niet warm!

### BEVESTIGINGEN

- Muurbevestigingen standaard

### TECHNISCH

- KTL-grondlaag, poedercoating
- Standaardwerkdruk: 4 bar
- Maximale bedrijfstemperatuur: 110°C

### ELEKTRISCH (zie hoofdstuk elektrische radiatoren)

- ✗ Zuiver elektrische radiator in de fabriek voorgevuld
- ✗ Gemengde radiator

### TECHNISCHE TEKENINGEN

- Zie p. 51

### AANSLUITING

- ✗ Eénpuntsaansluiting voor éénpijpssysteem
- ✗ Eénpuntsaansluiting voor tweepijpssysteem
- ✓ Tweepuntsaansluiting voor éénpijpssysteem (aansluiting via de middenaansluiting) (zie p. 300)
- ✓ Tweepuntsaansluiting voor tweepijpssysteem (standaard) (zie p. 300)
- ✗ Geïntegreerd ventiel

### OVER ARCHE PLUS VERTICAAL

#### Functioneel mooi over de hele lijn

Een designradiator waarbij de unieke, vlakke vormgeving van de Arche wordt aangevuld met een naadloos op de structuur gelaste handdoekbeugel. Samen vormen ze een mooi afgewerkt geheel dat de perfecte verstandhouding tussen de Arche vormgeving en functionaliteit extra benadrukt.

### AANBEVOLEN AANSLUITING (1188)

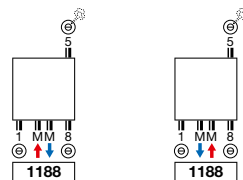

### Andere aansluitmogelijkheden, zie p. 50



art. nr. 118210300000099

**prijs € 155**

Koppelingen, zie p. 313



## HOE ARCHE PLUS VERTICAAL BESTELLEN

Leveringstermijn 15 - 30 werkdagen  
(zonder transportduur)

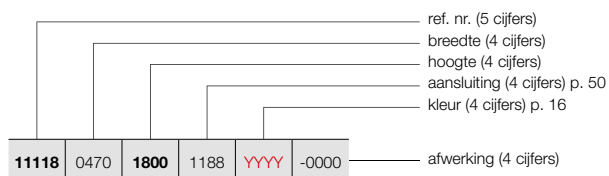

## ARCHE PLUS VERTICAAL (VL, VWR)



VWR

BESTELCODE MAATWERK ARCHE PLUS VERTICAAL	TECHNISCHE GEGEVENS									STANDAARDKLEUR	ANDERE KLEUREN					
	buizen	breedte (L mm)	hoogte (H mm)	75/65/20 (Watt)	55/45/20 (Watt)	n-exp.	gewicht (kg)	inhoud (l)	el. weerst. (Watt)	prijs RAL 9016	prijs kleur					
<b>REF. NR. ARCHE PLUS VERTICAAL VL : 11118</b>																
<b>11118</b>	0470	<b>1800</b>	1188	YYYY	-0000	10	470	1800	1050	560	1,23	23,49	13,94	-	<b>505</b>	<b>581</b>
		<b>2000</b>				10	470	2000	1164	618	1,24	25,95	15,42	-	<b>540</b>	<b>621</b>
		<b>2200</b>				10	470	2200	1279	679	1,24	28,40	16,91	-	<b>570</b>	<b>656</b>
<b>11118</b>	0570	<b>1800</b>	1188	YYYY	-0000	12	570	1800	1273	679	1,23	28,44	16,90	-	<b>612</b>	<b>704</b>
		<b>2000</b>				12	570	2000	1412	749	1,24	31,42	18,70	-	<b>654</b>	<b>752</b>
		<b>2200</b>				12	570	2200	1552	824	1,24	34,40	20,50	-	<b>690</b>	<b>794</b>
<b>11118</b>	0670	<b>1800</b>	1188	YYYY	-0000	14	670	1800	1496	798	1,23	33,39	19,87	-	<b>719</b>	<b>827</b>
		<b>2000</b>				14	670	2000	1660	881	1,24	36,89	21,98	-	<b>769</b>	<b>884</b>
		<b>2200</b>				14	670	2200	1824	968	1,24	40,39	24,10	-	<b>811</b>	<b>933</b>
<b>REF. NR. ARCHE PLUS VERTICAAL VWR : 11119</b>																
<b>11119</b>	0470	<b>1800</b>	1188	YYYY	-0000	10	470	1800	1050	560	1,23	23,49	13,94	-	<b>505</b>	<b>581</b>
		<b>2000</b>				10	470	2000	1164	618	1,24	25,95	15,42	-	<b>540</b>	<b>621</b>
		<b>2200</b>				10	470	2200	1279	679	1,24	28,40	16,91	-	<b>570</b>	<b>656</b>
<b>11119</b>	0570	<b>1800</b>	1188	YYYY	-0000	12	570	1800	1273	679	1,23	28,44	16,90	-	<b>612</b>	<b>704</b>
		<b>2000</b>				12	570	2000	1412	749	1,24	31,42	18,70	-	<b>654</b>	<b>752</b>
		<b>2200</b>				12	570	2200	1552	824	1,24	34,40	20,50	-	<b>690</b>	<b>794</b>
<b>11119</b>	0670	<b>1800</b>	1188	YYYY	-0000	14	670	1800	1496	798	1,23	33,39	19,87	-	<b>719</b>	<b>827</b>
		<b>2000</b>				14	670	2000	1660	881	1,24	36,89	21,98	-	<b>769</b>	<b>884</b>
		<b>2200</b>				14	670	2200	1824	968	1,24	40,39	24,10	-	<b>811</b>	<b>933</b>

CE07 conform EN442-1: radiatoren en convectoren

Voor de warmteafgiftes van andere regimes, kijkt u op p. 308 (correctiefactoren)  
Prijzen in euro (excl. BTW)

## ARCHE BAD (AB)



### BUIZEN

- AB: Horizontaal, rechthoekig 45 x 20 mm

### KLEUREN

- Standaardkleur wit RAL 9016
- Niet verkrijgbaar in kleuren Gloss White en Jet Black
- Uitgebreide kleurenkaart zie p. 16

### SPECIAAL

- De Arche is bekroond met Design Plus Award 2005, Reddot Design Award 2006, Silver Award Designpreis Deutschland 2006 en genomineerd voor de Henry van de Velde prijs 2005.
- Radiator met uitsparingen

### BEVESTIGINGEN

- Muurbevestigingen standaard

### TECHNISCH

- KTL-grondlaag, poedercoating
- Standaardwerkdruk: 4 bar
- Maximale bedrijfstemperatuur: 110°C

### ELEKTRISCH (zie hoofdstuk elektrische radiatoren)

- ✗ Zuiver elektrische radiator in de fabriek vorgevuld
- ✗ Gemengde radiator

### TECHNISCHE TEKENINGEN

- Zie p. 52

### AANSLUITING

- ✗ Eénpuntsaansluiting voor éénpijpsysteem
- ✗ Eénpuntsaansluiting voor tweepijpsysteem
- ✓ Tweepuntsaansluiting voor éénpijpsysteem (aansluiting via de middenaansluiting) (zie p. 300)
- ✓ Tweepuntsaansluiting voor tweepijpsysteem (standaard) (zie p. 300)
- ✗ Geïntegreerd ventiel

### OVER ARCHE BAD

#### Vierkant de mooiste, en de meest praktische

Een klassiek voorbeeld van slim toegepast design, praktisch en montagevriendelijk dankzij de slimme middenaansluiting die vorm en efficiëntie op een unieke manier met elkaar verbindt. Het strakke, rustgevende karakter versterkt het wellnessgevoel. De warmteafgifte op maat, de doordachte accessoires en de goede verstandhouding met lage temperatuursystemen zijn evenzoveel garanties voor een duurzame investering met een blijvend rendement.

### AANBEVOLEN AANSLUITING (1188)

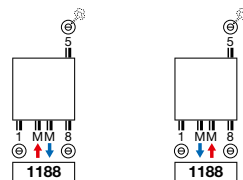

#### Andere aansluitmogelijkheden, zie p. 50

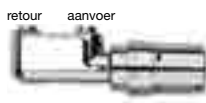

art. nr. 118210300000099  
**prijs € 155**  
Koppelingen, zie p. 313

### AANBEVOLEN VOOR BADKAMER IN OPTIE



knop brede gleuf (chrom) art. nr. 118340300000099  
**prijs € 28**

#### Andere accessoires, zie p. 50



### HOE ARCHE BAD BESTELLEN

Leveringstermijn 15 - 30 werkdagen  
(zonder transportduur)

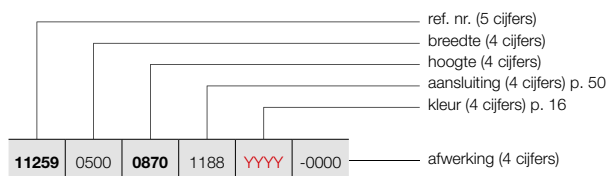

11259	0500	0870	1188	YYYY	-0000
-------	------	------	------	------	-------

### ARCHE BAD (AB)



AB

### HOE VOORRAADRADIATOR ARCHE BAD BESTELLEN

Leveringstermijn 5 werkdagen  
(zonder transportduur)

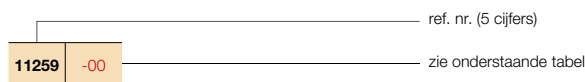

11259	-00
-------	-----

BESTELCODE MAATWERK ARCHE BAD	TECHNISCHE GEGEVENS									STANDAARDKLEUR		ANDERE KLEUREN					
	buizen	breedte (L mm)	hoogte (H mm)	75/65/20 (Watt)	55/45/20 (Watt)	n-exp.	gewicht (kg)	inhoud (l)	el. weerst. (Watt)	prijs RAL 9016	verkorte ref. nr. RAL 9016 voorraad	prijs kleur					
<b>REF. NR. ARCHE BAD AB : 11259</b>																	
11259	0500	0870	1188	YYYY	-0000	16	500	870	502	264	1,26	12,20	6,55	-	475	-	546
		1470				28	500	1470	805	419	1,28	20,65	11,45	-	675	-	776
		1870				36	500	1870	1022	531	1,28	25,65	14,15	-	785	11259-02	903
11259	0600	0870	1188	YYYY	-0000	16	600	870	588	311	1,25	14,10	7,58	-	496	-	570
		1470				28	600	1470	942	487	1,29	24,03	13,35	-	707	-	813
		1870				36	600	1870	1197	622	1,28	29,93	17,05	-	820	11259-03	943
11259	0700	0870	1188	YYYY	-0000	16	700	870	672	357	1,24	16,00	8,60	-	508	-	584
		1470				28	700	1470	1077	557	1,29	27,40	15,25	-	721	-	829
		1870				36	700	1870	1368	711	1,28	34,20	19,95	-	835	-	960

CE 13 conform EN442-1: radiatoren en convectoren

Voor de warmteafgiftes van andere regimes, kijkt u op p. 308 (correctiefactoren)  
Prijzen in euro (excl. BTW)



ACCESSOIRES	KLEUR	ART. NR.	€
<b>KNOP O-RING</b>  <ul style="list-style-type: none"> <li>h = 22 mm; b = 22 mm; d = 42 mm</li> </ul>	<b>VV / AB</b>		
	CHROOM	118360300000099	<b>28</b>
<b>KNOP BREDE GLEUF</b>  <ul style="list-style-type: none"> <li>h = 22 mm; b = 22 mm; d = 42 mm</li> </ul>	<b>VV / AB</b>		
	CHROOM	118340300000099	<b>28</b>
<b>HANDDOEKBEUGEL</b>  <ul style="list-style-type: none"> <li>h = 22 mm; b = 720 mm (zelf in te korten) d = 75 mm; a = 56 mm</li> </ul>	<b>VV</b>		
	CHROOM	118322800000099	<b>166</b>

d = afstand voorkant accessoire tot voorkant radiator  
a = afstand accessoire tot radiator  
**uit voorraad leverbaar**

## ARCHE AANSLUITINGEN

**ARCHE VERTICAAL:** VV  
**ARCHE PLUS VERTICAAL:** VWL / VWR  
**ARCHE BAD:** AB

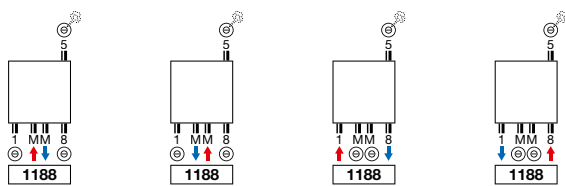

**Opmerking:** het aansluiten van de radiator kan enkel volgens de getoonde aansluiticonen. Voor elke andere aansluitwijze nemen wij geen verantwoordelijkheid.

ARCHE VERTICAAL (VV)

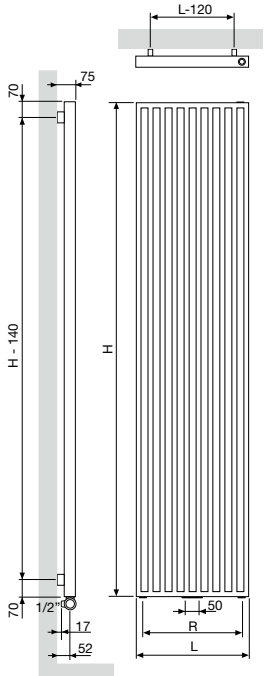

	<b>w</b>		
Aantal buizen	10	12	14
Breedte (L)	470	570	670
Hartafstand tussen de onderaansluitingen 18 (R)	370	470	570
Hartafstand tussen de ophangingen	L-120	H-140	

ARCHE PLUS VERTICAAL (VL, VR)

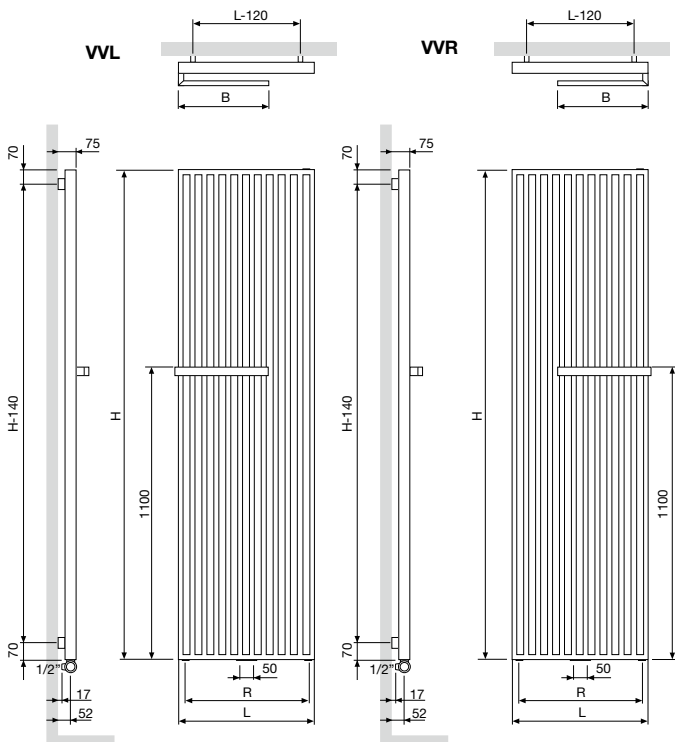

	<b>VL / VR</b>		
Aantal buizen	10	12	14
Breedte (L)	470	570	670
Hartafstand tussen de onderaansluitingen 18 (R)	370	470	570
Breedte handdoekbeugel (B)	335	385	435
Hartafstand tussen de ophangingen	L-120	H-140	

ARCHE BAD (AB)

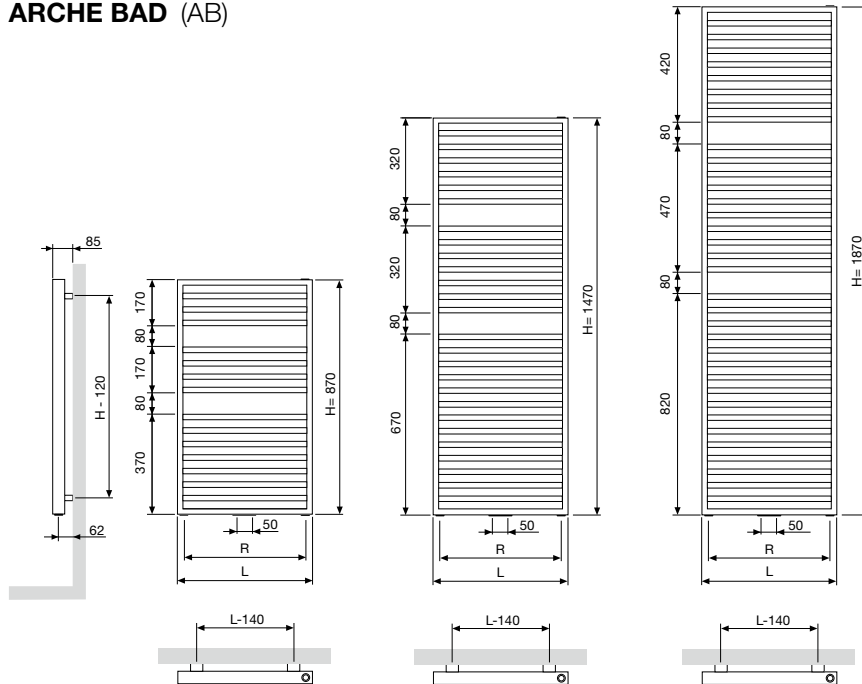

	<b>AB</b>		
Breedte (L)	500	600	700
Hartafstand tussen de onderaansluitingen 18 (R)	400	500	600
Hartafstand tussen de ophangingen	L-140	H-120	

**TYPES**

- Enkel (N1L1) en dubbel (N2L1)

**KLEUREN**

- Standaardkleur S600 (witte fijn structuurlak)
- Niet verkrijgbaar in kleuren Gloss White en Jet Black
- Uitgebreide kleurenkaart zie p. 16

**SPECIAAL**

- De Niva Lak Verticaal is beschikbaar met een gelakte voorplaat (dwz. plaatradiator + gelakte voorplaat).

**BEVESTIGINGEN**

- Muurbevestigingen in de kleur RAL 7016 (antraciet grijs) standaard. Ook in optie verkrijgbaar in de kleur S600 (zie p. 62).

**TECHNISCH**

- Elektrisch weerstandsgelast (onzichtbare lasnaden) en rolnaadgelast
- KTL-grondlaag, poedercoating
- Standaardwerkdruk: 10 bar
- Maximale bedrijfstemperatuur: 110°C

**ELEKTRISCH** (zie hoofdstuk elektrische radiatoren)

- ✓ Zuiver elektrische radiator in de fabriek vorgevuld (zie p. 289)
- ✗ Gemengde radiator

**TECHNISCHE TEKENINGEN**

- Zie p. 66

**AANSLUITING**

- ✗ Eénpuntsaansluiting voor éénpijpsysteem
- ✗ Eénpuntsaansluiting voor tweepijpsysteem
- ✓ Tweepuntsaansluiting voor éénpijpsysteem (aansluiting via de middenaansluiting (zie p. 300)
- ✓ Tweepuntsaansluiting voor tweepijpsysteem (standaard) (zie p. 300)
- ✗ Geïntegreerd ventiel



**AANBEVOLEN AANSLUITING (1188)**

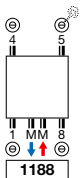

**Andere aansluitmogelijkheden, zie p. 65**

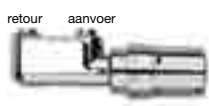

art. nr. 118210300000099  
**prijs € 155**  
 Koppelingen, zie p. 313

**AANBEVOLEN VOOR BADKAMER  
 IN OPTIE**



handdoekbeugel (chrom) N1L1 art. nr. 118321300000099 (420 mm)  
**prijs € 166**

N2L1 art. nr. 118321800000099 (420 mm)  
**prijs € 166**

**Andere accessoires, zie p. 63**

**OVER NIVA LAK VERTICAAL**

**Puur technische klasse, puur design, puur sfeer**

De ultracompacte, gestyleerde Niva is nog steeds een stichtend voorbeeld voor heel wat ontwerpers en collega-producenten. Eén en al functionaliteit door de optimale luchtdoorstroming en de extra hoge warmteafgifte die meteen op gang komt. Eén en al design door de integere, zuivere vormgeving, het zwevend karakter –dankzij de achterliggende, onzichtbare ophanging- en de organisch geïntegreerde handdoekbeugel.



# NIVA LAK VERTICAAL (N1L1, N2L1)



N1L1

N2L1

## HOE NIVA LAK VERTICAAL BESTELLEN

Leveringstermijn 15 - 30 werkdagen  
(zonder transportduur)

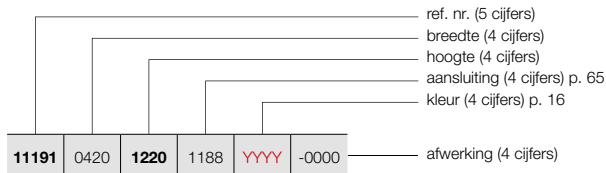

## HOE VOORRAADRADIATOR NIVA LAK VERTICAAL BESTELLEN

Leveringstermijn 5 werkdagen  
(zonder transportduur)

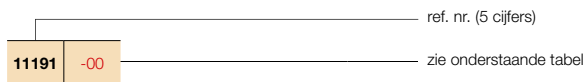

BESTELCODE MAATWERK NIVA LAK VERTICAAL						TECHNISCHE GEGEVENS									STANDAARDKLEUR		ANDERE KLEUREN	
						buizen	breedte (L mm)	hoogte (H mm)	75/65/20 (Watt)	55/45/20 (Watt)	n-exp.	gewicht (kg)	inhoud (l)	el. weerst. (Watt)	prijs S600	verkorte ref. nr. S600 voorraad	prijs kleur	verkorte ref. nr. M301 voorraad
<b>REF. NR. NIVA LAK VERTICAAL N1L1 : 11191</b>																		
11191	0420	1220	1188	YYYY	-0000	-	420	1220	645	337	1,27	18,10	2,55	-	368	11191-02	423	-
		1820				-	420	1820	934	486	1,28	27,35	3,70	-	428	11191-03	492	11191-05
		2020				-	420	2020	1023	532	1,28	30,20	4,00	-	454	11191-06	522	-
		2220				-	420	2220	1070	559	1,27	33,20	4,50	-	492	-	566	-
11191	0520	1220	1188	YYYY	-0000	-	520	1220	815	424	1,28	21,97	3,32	-	415	11191-21	477	-
		1820				-	520	1820	1128	587	1,28	33,67	4,61	-	482	11191-16	554	11191-01
		2020				-	520	2020	1257	654	1,28	37,12	5,05	-	511	11191-22	588	-
		2220				-	520	2220	1310	681	1,28	40,88	5,57	-	554	-	637	-
11191	0620	1220	1188	YYYY	-0000	-	620	1220	985	510	1,29	25,83	3,85	-	432	11191-07	497	-
		1820				-	620	1820	1322	687	1,28	39,98	5,52	-	501	11191-17	576	11191-04
		2020				-	620	2020	1490	775	1,28	44,03	6,10	-	533	11191-20	613	-
		2220				-	620	2220	1550	806	1,28	48,57	6,63	-	578	-	665	-
11191	0720	1820	1188	YYYY	-0000	-	720	1820	1515	784	1,29	46,30	6,43	-	523	11191-08	601	-
		2020				-	720	2020	1724	897	1,28	50,95	7,15	-	556	11191-09	639	-
		2220				-	720	2220	1790	926	1,29	56,25	7,70	-	605	-	696	-
<b>REF. NR. NIVA LAK VERTICAAL N2L1 : 11192</b>																		
11192	0420	1220	1188	YYYY	-0000	-	420	1220	988	506	1,31	28,40	4,90	-	552	11192-01	635	-
		1820				-	420	1820	1330	681	1,31	42,23	7,28	-	641	11192-02	737	11192-03
		2020				-	420	2020	1438	736	1,31	46,75	8,00	-	666	11192-04	766	-
		2220				-	420	2220	1543	823	1,23	51,40	8,90	-	710	-	817	-
11192	0520	1220	1188	YYYY	-0000	-	520	1220	1213	621	1,31	36,83	6,48	-	621	11192-05	714	-
		1820				-	520	1820	1633	836	1,31	51,68	9,07	-	722	11192-31	830	11192-06
		2020				-	520	2020	1764	903	1,31	57,23	10,00	-	750	11192-32	863	-
		2220				-	520	2220	1893	995	1,26	62,73	11,00	-	799	-	919	-
11192	0620	1220	1188	YYYY	-0000	-	620	1220	1437	732	1,32	38,17	7,02	-	646	11192-37	743	-
		1820				-	620	1820	1935	991	1,31	61,14	10,86	-	750	11192-33	863	11192-12
		2020				-	620	2020	2091	1071	1,31	67,72	12,00	-	782	11192-34	899	-
		2220				-	620	2220	2243	1160	1,29	74,07	13,10	-	833	-	958	-
11192	0720	1820	1188	YYYY	-0000	-	720	1820	2237	1146	1,31	70,60	12,65	-	782	11192-07	899	-
		2020				-	720	2020	2417	1238	1,31	78,20	14,00	-	816	11192-35	938	-
		2220				-	720	2220	2594	1322	1,32	85,40	15,20	-	872	-	1003	-

CE<sub>05</sub> conform EN442-1: radiatoren en convectoren

Voor de warmteafgiftes van andere regimes, kijkt u op p. 308 (correctiefactoren)  
Prijzen in euro (excl. BTW)

#### TYPES

- Enkel (N1L1-ES) en dubbel (N2L1-ES)

#### KLEUREN

- Inox / RVS type 316L, mat geborsteld met korrel 360

#### SPECIAAL

- De Niva Inox Verticaal is beschikbaar met een inox voorplaat (dwz. stalen plaatradiator + inox-voorplaat).
- De Niva Inox Verticaal wordt standaard geleverd met een onderhoudsproduct.
- Dit onderhoudsproduct is niet na te leveren door Vasco.

#### BEVESTIGINGEN

- Muurbevestigingen in de kleur RAL 7016 (antraciet grijs) standaard. Ook in optie verkrijgbaar in de kleur S600 (zie p. 62).

#### TECHNISCH

- Elektrisch weerstandsgelast (onzichtbare lasnaden) en rolhaadgelast
- Standaardwerkdruk: 10 bar
- Maximale bedrijfstemperatuur: 110°C

#### ELEKTRISCH (zie hoofdstuk elektrische radiatoren)

- ✗ Zuiver elektrische radiator in de fabriek vorgevuld
- ✗ Gemengde radiator

#### TECHNISCHE TEKENINGEN

- Zie p. 66

#### AANSLUITING

- ✗ Eénpuntsaansluiting voor éénpijpsysteem
- ✗ Eénpuntsaansluiting voor tweepijpsysteem
- ✓ Tweepuntsaansluiting voor éénpijpsysteem (aansluiting via de middenaansluiting (zie p. 300))
- ✓ Tweepuntsaansluiting voor tweepijpsysteem (standaard) (zie p. 300)
- ✗ Geïntegreerd ventiel



#### AANBEVOLEN AANSLUITING (1188)

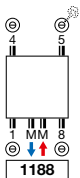

#### Andere aansluitmogelijkheden, zie p. 65



art. nr. 118210300009993  
**prijs € 182**  
 Koppelingen, zie p. 313

#### AANBEVOLEN VOOR BADKAMER IN OPTIE



handdoekbeugel (inox)  
 N1L1-ES art. nr. 118321400009993 (520 mm)  
**prijs € 166**

N2L1-ES art. nr. 118321900009993 (520 mm)  
**prijs € 166**

**Andere accessoires, zie p. 63**

#### OVER NIVA INOX VERTICAAL

##### Pure klasse in al haar pracht

De Niva Inox Verticaal combineert een stalen plaatradiator met een inox voorplaat, die de integere, zuivere vormgeving en het zwevende karakter van de Niva letterlijk 'extra glans' geeft. De Niva Inox Verticaal designradiator is ook leverbaar met organisch geïntegreerde inox handdoekbeugel (in optie).

# NIVA INOX VERTICAAL (N1L1-ES, N2L1-ES)

## HOE NIVA INOX VERTICAAL BESTELLEN

Leveringstermijn 15 - 30 werkdagen  
(zonder transportduur)



N1L1-ES



N2L1-ES

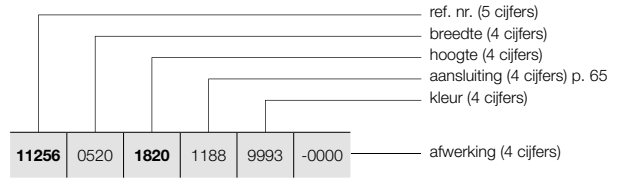

BESTELCODE MAATWERK NIVA INOX VERTICAAL							TECHNISCHE GEGEVENS							STANDAARDKLEUR		
							buizen	breedte (L mm)	hoogte (H mm)	75/65/20 (Watt)	55/45/20 (Watt)	n-exp.	gewicht (kg)	inhoud (l)	el. weerst. (Watt)	prijs inox
<b>REF. NR. NIVA INOX VERTICAAL N1L1-ES : 11256</b>																
<b>11256</b>	0520	<b>1820</b>	1188	9993	-0000	-	520	1820	1128	587	1,28	33,67	4,61	-	<b>868</b>	-
		<b>2020</b>				-	520	2020	1257	654	1,28	37,12	5,05	-	<b>920</b>	-
<b>11256</b>	0620	<b>1820</b>	1188	9993	-0000	-	620	1820	1322	687	1,28	39,98	5,52	-	<b>902</b>	-
		<b>2020</b>				-	620	2020	1490	775	1,28	44,03	6,10	-	<b>960</b>	-
<b>REF. NR. NIVA INOX VERTICAAL N2L1-ES : 11257</b>																
<b>11257</b>	0520	<b>1820</b>	1188	9993	-0000	-	520	1820	1633	836	1,31	51,68	9,07	-	<b>1299</b>	-
		<b>2020</b>				-	520	2020	1764	903	1,31	57,23	10,00	-	<b>1349</b>	-
<b>11257</b>	0620	<b>1820</b>	1188	9993	-0000	-	620	1820	1935	991	1,31	61,14	10,86	-	<b>1350</b>	-
		<b>2020</b>				-	620	2020	2091	1071	1,31	67,72	12,00	-	<b>1408</b>	-

CE 06 conform EN442-1: radiatoren en convectoren

Voor de warmteafgiftes van andere regimes, kijkt u op p. 308 (correctiefactoren)  
 Prijzen in euro (excl. BTW)

#### TYPES

- NH1L1, NH2L1, NH2L2

#### KLEUREN

- Standaardkleur S600 (witte fijn structuurlak)
- Niet verkrijgbaar in kleuren Gloss White en Jet Black
- Uitgebreide kleurenkaart zie p. 16

#### SPECIAAL

- De Niva Lak Horizontaal is verkrijgbaar met 1 (NH1L1, NH2L1) of 2 rijen (NH2L2) lamellen ter verhoging van de warmteafgifte.
- NH1L1 ook verkrijgbaar als toiletradiator (520 x 450 mm)

#### BEVESTIGINGEN

- Muurbevestigingen in de kleur RAL 7016 (antraciet grijs) standaard. Ook in optie verkrijgbaar in de kleur S600 (zie p. 62).

#### TECHNISCH

- Elektrisch weerstandsgelast (onzichtbare lasnaden) en rolnaadgelast
- KTL-grondlaag, poedercoating
- Standaardwerkdruk: 10 bar
- Maximale bedrijfstemperatuur: 110°C

#### ELEKTRISCH (zie hoofdstuk elektrische radiatoren)

- ✗ Zuiver elektrische radiator in de fabriek voorgevuld
- ✗ Gemengde radiator

#### TECHNISCHE TEKENINGEN

- Zie p. 67

#### AANSLUITING

- ✗ Eénpuntsaansluiting voor éénpijpsysteem
- ✗ Eénpuntsaansluiting voor tweepijpsysteem
- ✓ Tweepuntsaansluiting voor éénpijpsysteem (aansluiting via het geïntegreerd ventiel) (zie p. 302)
- ✓ Tweepuntsaansluiting voor tweepijpsysteem (standaard) (zie p. 300)
- ✓ Geïntegreerd ventiel (**geen meerprijs**) (zie p. 302)

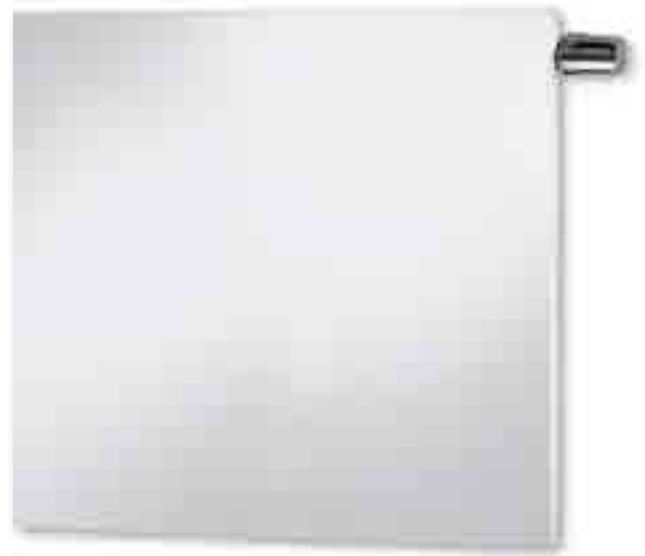

#### GEÏNTEGREERD VENTIEL NIVA LAK HORIZONTAAL

- Radiator in wit: thermostaatkop in wit standaard, in de prijs inbegrepen
- Radiator in kleur: thermostaatkop in chroom standaard, in de prijs inbegrepen
- **Thermostaatkop in een andere kleur is mogelijk in optie - niet in de prijs inbegrepen**

#### AANBEVOLEN AANSLUITING (0098) GEÏNTEGREERD VENTIEL

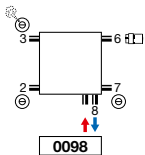

Andere aansluitmogelijkheden, zie p. 65



art. nr. 118230000000099

**prijs € 104**

Koppelingen, zie p. 313

#### AANBEVOLEN VOOR BADKAMER IN OPTIE



handdoekbeugel (chroom)

art. nr. 118321700000099

**prijs € 166**

#### OVER NIVA LAK HORIZONTAAL

##### Pure klasse in al haar eenvoud

Ook in de horizontale versie is en blijft de Niva een toonbeeld van efficiënte toegepaste vormgeving. Een geslaagde combinatie van functionaliteit en design, met de keuze uit 1 of 2 lamellen voor een aangepaste warmteafgifte, ook beschikbaar in toiletversie. Met optionele handdoekbeugel in chroomuitvoering.





# NIVA HORIZONTAAL (NH1L1, NH2L1)



NH1L1 / NH2L1

## HOE NIVA LAK HORIZONTAAL BESTELLEN

Leveringstermijn 15 - 30 werkdagen  
(zonder transportduur)

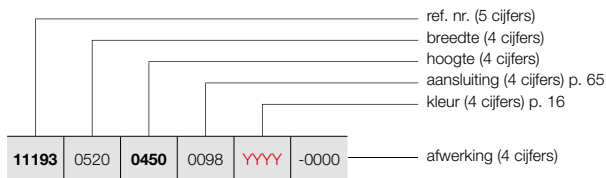

## HOE VOORRAADRADIATOR NIVA LAK HORIZONTAAL BESTELLEN

Leveringstermijn 5 werkdagen  
(zonder transportduur)

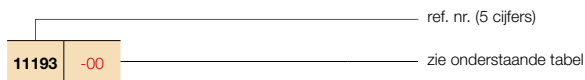

BESTELCODE MAATWERK NIVA LAK HORIZONTAAL	TECHNISCHE GEGEVENS										STANDAARDKLEUR		ANDERE KLEUREN
	buizen	breedte (L mm)	hoogte (H mm)	75/65/20 (Watt)	55/45/20 (Watt)	n-exp.	gewicht (kg)	inhoud (l)	el. weerst. (Watt)	prijs S600	verkorte ref. nr. S600 voorraad	prijs kleur	
<b>REF. NR. NIVA LAK HORIZONTAAL NH1L1 : 11193</b>													
11193 0520 0450 0098 YYY YYY -0000	-	520	450	301	158	1,26	7,50	1,19	-	312	11193-01	359	
11193 0620 0550 0098 YYY YYY -0000	-	620	550	425	223	1,26	11,11	1,66	-	346	-	398	
	-	620	650	490	256	1,27	13,28	1,92	-	409	-	470	
11193 0820 0550 0098 YYY YYY -0000	-	820	550	562	295	1,26	14,69	2,20	-	402	-	462	
	-	820	650	649	339	1,27	17,56	2,53	-	464	-	534	
11193 1020 0550 0098 YYY YYY -0000	-	1020	550	699	367	1,26	18,28	2,73	-	457	-	526	
	-	1020	650	807	422	1,27	21,85	3,15	-	519	-	597	
	-	1020	950	1124	585	1,28	31,85	4,40	-	620	-	713	
11193 1220 0550 0098 YYY YYY -0000	-	1220	550	836	439	1,26	21,86	3,27	-	512	-	589	
	-	1220	650	965	504	1,27	26,13	3,77	-	575	-	661	
	-	1220	950	1344	699	1,28	38,10	5,26	-	676	-	777	
<b>REF. NR. NIVA LAK HORIZONTAAL NH2L1 : 11194</b>													
11194 0620 0550 0098 YYY YYY -0000	-	620	550	611	318	1,28	17,25	3,27	-	478	-	550	
	-	620	650	708	370	1,27	20,70	3,83	-	575	-	661	
11194 0820 0550 0098 YYY YYY -0000	-	820	550	809	421	1,28	22,81	4,32	-	540	-	621	
	-	820	650	936	489	1,27	27,37	5,07	-	637	-	733	
11194 1020 0550 0098 YYY YYY -0000	-	1020	550	1006	523	1,28	28,38	5,38	-	602	11194-08	692	
	-	1020	650	1165	609	1,27	34,05	6,30	-	699	11194-23	804	
	-	1020	950	1630	839	1,30	50,20	9,05	-	830	-	955	
11194 1220 0550 0098 YYY YYY -0000	-	1220	550	1203	626	1,28	33,94	6,43	-	665	-	765	
	-	1220	650	1393	728	1,27	40,72	7,54	-	762	-	876	
	-	1220	950	1950	1004	1,30	60,05	10,82	-	899	-	1034	
11194 1420 0550 0098 YYY YYY -0000	-	1420	550	1400	728	1,28	39,50	7,48	-	774	-	890	
	-	1420	650	1622	848	1,27	47,40	8,78	-	887	-	1020	
11194 1620 0550 0098 YYY YYY -0000	-	1620	550	1597	830	1,28	45,07	8,54	-	882	-	1014	
	-	1620	650	1850	967	1,27	54,08	10,01	-	1012	-	1164	

CE 05 conform EN442-1: radiatoren en convectoren

Voor de warmteafgifte van andere regimes, kijkt u op p. 308 (correctiefactoren)

Prijzen in euro (excl. BTW)

### HOE NIVA LAK HORIZONTAAL BESTELLEN

Leveringstermijn 15 - 30 werkdagen  
(zonder transportduur)

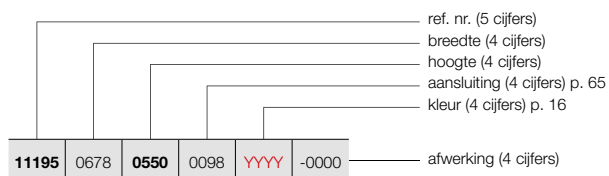

### NIVA HORIZONTAAL (NH2L2)



NH2L2

### HOE VOORRAADRADIATOR NIVA LAK HORIZONTAAL BESTELLEN

Leveringstermijn 5 werkdagen  
(zonder transportduur)

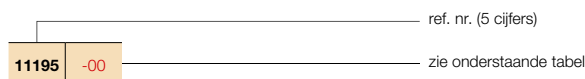

BESTELCODE MAATWERK NIVA LAK HORIZONTAAL	TECHNISCHE GEGEVENS									STANDAARDKLEUR		ANDERE KLEUREN
	buizen	breedte (L mm)	hoogte (H mm)	75/65/20 (Watt)	55/45/20 (Watt)	n-exp.	gewicht (kg)	inhoud (l)	el. weerst. (Watt)	prijs S600	verkorte ref. nr. S600 voorraad	prijs kleur
<b>REF. NR. NIVA LAK HORIZONTAAL NH2L2 : 11195</b>												
11195 0678 0550 0098 YYY -0000	-	678	550	804	416	1,29	20,50	3,40	-	589	-	677
	-	678	650	941	487	1,29	24,28	3,93	-	665	-	765
11195 0878 0550 0098 YYY -0000	-	878	550	1041	539	1,29	26,55	4,40	-	672	-	773
	-	878	650	1219	631	1,29	31,44	5,09	-	748	-	860
11195 1078 0550 0098 YYY -0000	-	1078	550	1279	662	1,29	32,60	5,40	-	755	11195-15	868
	-	1078	650	1496	774	1,29	38,60	6,25	-	831	11195-16	956
	-	1078	950	2027	1043	1,30	57,90	9,00	-	968	-	1113
11195 1278 0550 0098 YYY -0000	-	1278	550	1516	784	1,29	38,65	6,40	-	838	-	964
	-	1278	650	1774	918	1,29	45,77	7,41	-	914	-	1051
	-	1278	950	2403	1237	1,30	68,64	10,67	-	1051	-	1209
11195 1478 0550 0098 YYY -0000	-	1478	550	1753	907	1,29	44,69	7,40	-	969	-	1114
	-	1478	650	2051	1061	1,29	52,93	8,57	-	1057	-	1216
11195 1678 0550 0098 YYY -0000	-	1678	550	1990	1030	1,29	50,74	8,41	-	1100	-	1265
	-	1678	650	2329	1205	1,29	60,09	9,73	-	1200	-	1380

CE 05 conform EN442-1: radiatoren en convectoren

Voor de warmteafgiftes van andere regimes, kijkt u op p. 308 (correctiefactoren)  
 Prijzen in euro (excl. BTW)

## NIVA SOFT VERTICAAL (NS1L1, NS2L1)



### TYPES

- Enkel (NS1L1) en dubbel (NS2L1)

### KLEUREN

- Standaardkleur S600 (witte fijn structuurlak)
- Niet verkrijgbaar in kleuren Gloss White en Jet Black
- Uitgebreide kleurenkaart zie p. 16

### SPECIAAL

- De Niva Soft Verticaal is beschikbaar met een gelakte voorplaat (dwz. stalen plaatradiator + gelakte voorplaat).
- Vlakke voorplaat en afgeronde zijkanten als hedendaagse troef
- Thermostaatkop op deurknophoogte in optie (zie p. 302).

### BEVESTIGINGEN

- Muurbevestigingen in de kleur RAL 7016 (antraciet grijs) standaard. Ook in optie verkrijgbaar in de kleur S600 (zie p. 62).

### TECHNISCH

- Elektrisch weerstandsgelast (onzichtbare lasnaden) en rolnaadgelast
- KTL-grondlaag, poedercoating
- Standaardwerkdruk: 10 bar
- Maximale bedrijfstemperatuur: 110°C

### ELEKTRISCH (zie hoofdstuk elektrische radiatoren)

- ✗ Zuiver elektrische radiator in de fabriek vorgevuld
- ✗ Gemengde radiator

### TECHNISCHE TEKENINGEN

- Zie p. 68

### AANSLUITING

- ✗ Eénpuntsaansluiting voor éénpijpsysteem
- ✗ Eénpuntsaansluiting voor tweepijpsysteem
- ✓ Tweepuntsaansluiting voor éénpijpsysteem (aansluiting via de middenaansluiting) (zie p. 300)
- ✓ Tweepuntsaansluiting voor tweepijpsysteem (standaard) (zie p. 300)
- ✓ Geïntegreerd ventiel (**meerprijs €102**) (zie p. 302)



### OVER NIVA SOFT VERTICAAL

#### Pure klasse in al haar creativiteit

De Niva in al zijn compacte, gestyleerde eenvoud, maar nu in een uitvoering met zacht afgeronde zijkanten. Een designradiator die uitstekend tot zijn recht komt zowel in een minimalistisch interieur als in een eigentijdse retro-omgeving. Leverbaar met thermostaatkop op deurknophoogte.

### AANBEVOLEN AANSLUITING GEÏNTEGREERD VENTIEL (0098)

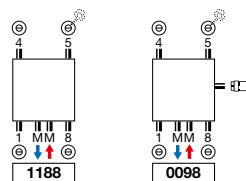

### Andere aansluitmogelijkheden, zie p. 65

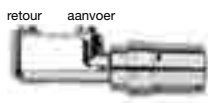

art. nr. 118210300000099  
**prijs € 155**  
Koppelingen, zie p. 313

### AANBEVOLEN VOOR BADKAMER IN OPTIE



handdoekbeugel (aluminium)  
NS1L1 art. nr. 118323900000000  
**prijs € 151**

NS2L1 art. nr. 118324000000000  
**prijs € 151**

### Andere accessoires, zie p. 63



art. nr. 118230100000099  
**prijs € 104**  
Koppelingen, zie p. 313



### HOE NIVA SOFT BESTELLEN

Leveringstermijn 15 - 30 werkdagen  
(zonder transportduur)

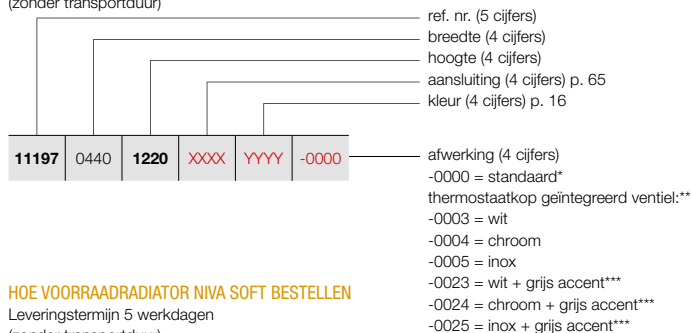

### HOE VOORRAADRADIATOR NIVA SOFT BESTELLEN

Leveringstermijn 5 werkdagen  
(zonder transportduur)

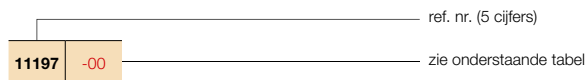

## NIVA SOFT VERTICAAL (NS1L1, NS2L1)



NS1L1





NS2L1

\* zonder geïntegreerd ventiel  
\*\* steeds aansluiting 0098  
\*\*\* enkel bij kleur S600

BESTELCODE MAATWERK NIVA SOFT VERTICAAL	TECHNISCHE GEGEVENS									STANDAARDKLEUR		ANDERE KLEUREN					
	buizen	breedte (L mm)	hoogte (H mm)	75/65/20 (Watt)	55/45/20 (Watt)	n-exp.	gewicht (kg)	inhoud (l)	el. weerst. (Watt)	prijs S600	verkorte ref. nr. S600 voorraad	prijs kleur					
<b>REF. NR. NIVA SOFT VERTICAAL NS1L1 : 11197</b>																	
11197	0440	1220	XXXX	YYYY	-0000	-	440	1220	645	337	1,27	18,10	2,55	-	368	11197-06	423
		1820				-	440	1820	934	486	1,28	27,35	3,70	-	428	11197-07	492
		2020				-	440	2020	1023	532	1,28	30,20	4,00	-	454	11197-08	522
		2220				-	440	2220	1070	559	1,27	33,20	4,50	-	492	-	566
11197	0540	1220	XXXX	YYYY	-0000	-	540	1220	815	424	1,28	21,97	3,32	-	415	11197-04	477
		1820				-	540	1820	1128	587	1,28	33,67	4,61	-	482	11197-01	554
		2020				-	540	2020	1257	654	1,28	37,12	5,05	-	511	11197-05	588
		2220				-	540	2220	1310	681	1,28	40,88	5,57	-	554	-	637
11197	0640	1220	XXXX	YYYY	-0000	-	640	1220	985	510	1,29	25,83	3,85	-	432	11197-09	497
		1820				-	640	1820	1322	687	1,28	39,98	5,52	-	501	11197-02	576
		2020				-	640	2020	1490	775	1,28	44,03	6,10	-	533	11197-03	613
		2220				-	640	2220	1550	806	1,28	48,57	6,63	-	578	-	665
11197	0740	1820	XXXX	YYYY	-0000	-	740	1820	1515	784	1,29	46,30	6,43	-	523	11197-10	601
		2020				-	740	2020	1724	897	1,28	50,95	7,15	-	556	11197-11	639
		2220				-	740	2220	1790	926	1,29	56,25	7,70	-	605	-	696
<b>REF. NR. NIVA SOFT VERTICAAL NS2L1 : 11198</b>																	
11198	0440	1220	XXXX	YYYY	-0000	-	440	1220	988	506	1,31	28,40	4,90	-	552	11198-06	635
		1820				-	440	1820	1330	681	1,31	42,23	7,28	-	641	11198-08	737
		2020				-	440	2020	1438	736	1,31	46,75	8,00	-	666	11198-09	766
		2220				-	440	2220	1543	823	1,23	51,40	8,90	-	710	-	817
11198	0540	1220	XXXX	YYYY	-0000	-	540	1220	1213	621	1,31	36,83	6,48	-	621	11198-10	714
		1820				-	540	1820	1633	836	1,31	51,68	9,07	-	722	11198-01	830
		2020				-	540	2020	1764	903	1,31	57,23	10,00	-	750	11198-02	863
		2220				-	540	2220	1893	995	1,26	62,73	11,00	-	799	-	919
11198	0640	1220	XXXX	YYYY	-0000	-	640	1220	1437	732	1,32	38,17	7,02	-	646	11198-07	743
		1820				-	640	1820	1935	991	1,31	61,14	10,86	-	750	11198-03	863
		2020				-	640	2020	2091	1071	1,31	67,72	12,00	-	782	11198-04	899
		2220				-	640	2220	2243	1160	1,29	74,07	13,10	-	833	-	958
11198	0740	1820	XXXX	YYYY	-0000	-	740	1820	2237	1146	1,31	70,60	12,65	-	782	11198-11	899
		2020				-	740	2020	2417	1238	1,31	78,20	14,00	-	816	11198-05	938
		2220				-	740	2220	2594	1322	1,32	85,40	15,20	-	872	-	1003

CE 09 conform EN442-1: radiatoren en convectoren







Voor de warmteafgiftes van andere regimes, kijkt u op p. 308 (correctiefactoren)  
Prijzen in euro (excl. BTW)

BEVESTIGINGEN		HOOGTE RADIATOR	KLEUR	ART. NR.	€
<b>N1L1 / N1L1-ES / NS1L1*</b>					
MUURBEVESTIGING		1220 mm	S600	118710411000600	<b>122</b>
		1820 mm	S600	118710417000600	<b>122</b>
		2020 mm	S600	118710419000600	<b>122</b>
		2220 mm	S600	118710421000600	<b>122</b>
<b>N2L1 / N2L1-ES / NS2L1</b>					
MUURBEVESTIGING		1220 mm	S600	118710511000600	<b>122</b>
		1820 mm	S600	118710517000600	<b>122</b>
		2020 mm	S600	118710519000600	<b>122</b>
		2220 mm	S600	118710521000600	<b>122</b>
<b>NH1L1</b>					
MUURBEVESTIGING		450 mm	S600	118710204000600	<b>40</b>
		550 mm	S600	118710205000600	<b>40</b>
		650 mm	S600	118710206000600	<b>40</b>
		950 mm	S600	118710209000600	<b>40</b>
<b>NH2L1 / NH2L2</b>					
MUURBEVESTIGING		550 mm	S600	118710305000600	<b>40</b>
		650 mm	S600	118710306000600	<b>40</b>
		950 mm	S600	118710309000600	<b>40</b>

\* niet beschikbaar voor NS1L1 met geïntegreerd ventiel

ACCESSOIRES	BREEDTE HANDDOEKBEUGEL	KLEUR	ART. NR.	€
<b>KORTE BEUGEL</b>  <ul style="list-style-type: none"> <li>• <b>N1L1 / N1L1-ES:</b> d = 66,5 mm; a = 56,5 mm</li> <li>• <b>NS1L1:</b> d = 68 mm; a = 58 mm</li> <li>• <b>N2L1 / N2L1-ES:</b> d = 59,5 mm; a = 49,5 mm</li> <li>• <b>NS2L1:</b> d = 58 mm; a = 48 mm</li> </ul>	<b>N1L1 / N1L1-ES / NS1L1</b>			
	240 mm	WIT	11837100000600	<b>108</b>
	240 mm	ZWART	11837100000300	<b>108</b>
	240 mm	DUIFBLAUW	11837100000601	<b>108</b>
	<b>N2L1 / N2L1-ES / NS2L1</b>			
	240 mm	WIT	11837200000600	<b>108</b>
	240 mm	ZWART	11837200000300	<b>108</b>
	240 mm	DUIFBLAUW	11837200000601	<b>108</b>
	<b>LANGE BEUGEL</b>  <ul style="list-style-type: none"> <li>• <b>N1L1 / N1L1-ES:</b> d = 66,5 mm; a = 56,5 mm</li> <li>• <b>NS1L1:</b> d = 68 mm; a = 58 mm</li> <li>• <b>N2L1 / N2L1-ES:</b> d = 59,5 mm; a = 49,5 mm</li> <li>• <b>NS2L1:</b> d = 58 mm; a = 48 mm</li> </ul>	<b>N1L1 / N1L1-ES / NS1L1</b>		
440 mm		WIT	118371100000600	<b>108</b>
440 mm		ZWART	118371100000300	<b>108</b>
440 mm		DUIFBLAUW	118371100000601	<b>108</b>
<b>N2L1 / N2L1-ES / NS2L1</b>				
440 mm		WIT	118372100000600	<b>108</b>
440 mm		ZWART	118372100000300	<b>108</b>
440 mm		DUIFBLAUW	118372100000601	<b>108</b>
<b>RECHTHOEK BEUGEL</b>  <ul style="list-style-type: none"> <li>• <b>N1L1 / N1L1-ES:</b> d = 66,5 mm; a = 56,5 mm</li> <li>• <b>NS1L1:</b> d = 68 mm; a = 58 mm</li> <li>• <b>N2L1 / N2L1-ES:</b> d = 59,5 mm; a = 49,5 mm</li> <li>• <b>NS2L1:</b> d = 58 mm; a = 48 mm</li> </ul>		<b>N1L1 / N1L1-ES / NS1L1</b>		
	286 x 110 mm	WIT	118371200000600	<b>139</b>
	286 x 110 mm	ZWART	118371200000300	<b>139</b>
	286 x 110 mm	DUIFBLAUW	118371200000601	<b>139</b>
	<b>N2L1 / N2L1-ES / NS2L1</b>			
	286 x 110 mm	WIT	118372200000600	<b>139</b>
	286 x 110 mm	ZWART	118372200000300	<b>139</b>
	286 x 110 mm	DUIFBLAUW	118372200000601	<b>139</b>
	<b>VIERKANT BEUGEL</b>  <ul style="list-style-type: none"> <li>• <b>N1L1 / N1L1-ES:</b> d = 66,5 mm; a = 56,5 mm</li> <li>• <b>NS1L1:</b> d = 68 mm; a = 58 mm</li> <li>• <b>N2L1 / N2L1-ES:</b> d = 59,5 mm; a = 49,5 mm</li> <li>• <b>NS2L1:</b> d = 58 mm; a = 48 mm</li> </ul>	<b>N1L1 / N1L1-ES / NS1L1</b>		
240 x 240 mm		WIT	118371300000600	<b>139</b>
240 x 240 mm		ZWART	118371300000300	<b>139</b>
240 x 240 mm		DUIFBLAUW	118371300000601	<b>139</b>
<b>N2L1 / N2L1-ES / NS2L1</b>				
240 x 240 mm		WIT	118372300000600	<b>139</b>
240 x 240 mm		ZWART	118372300000300	<b>139</b>
240 x 240 mm		DUIFBLAUW	118372300000601	<b>139</b>

d = afstand voorkant accessoire tot voorkant radiator  
a = afstand accessoire tot radiator  
**uit voorraad leverbaar**

ACCESSOIRES	BREEDTE RADIATOR	KLEUR	ART. NR.	€	
<b>N1L1 / N1L1-ES</b>					
<b>HANDDOEKBEUGEL</b>		420 mm	CHROOM	118321300000099	<b>166</b>
		520 mm	CHROOM	118321400000099	<b>166</b>
		520 mm	INOX/RVS	118321400009993	<b>166</b>
		620 mm	CHROOM	118321500000099	<b>166</b>
		620 mm	INOX/RVS	118321500009993	<b>166</b>
		720 mm	CHROOM	118321600000099	<b>166</b>
• h = 25 mm; b = 440, 540, 640, 740 mm; d = 73 mm; a = 57 mm					
<b>N2L1 / N2L1-ES</b>					
<b>HANDDOEKBEUGEL</b>		420 mm	CHROOM	118321800000099	<b>166</b>
		520 mm	CHROOM	118321900000099	<b>166</b>
		520 mm	INOX/RVS	118321900009993	<b>166</b>
		620 mm	CHROOM	118322000000099	<b>166</b>
		620 mm	INOX/RVS	118322000009993	<b>166</b>
		720 mm	CHROOM	118322100000099	<b>166</b>
• h = 25 mm; b = 440, 540, 640, 740 mm; d = 73 mm; a = 57 mm					
<b>NH1L1 / NH2L1 / NH2L2</b>					
<b>HANDDOEKBEUGEL</b>		CHROOM	118321700000099	<b>166</b>	
• h = 25 mm; b = 740 mm (zelf in te korten); d = 73 mm; a = 57 mm					
<b>N1L1 / N1L1-ES / NS1L1</b>					
<b>HANDDOEKBEUGEL</b>		ALUMINIUM	118323900000000	<b>151</b>	
		KOPER 	118323900000029	<b>161</b>	
• Handdoekbeugel in geanodiseerd aluminium • h = 55 mm; b = 326 mm; d = 57 mm; a = 51 mm					
<b>N2L1 / N2L1-ES / NS2L1</b>					
<b>HANDDOEKBEUGEL</b>		ALUMINIUM	118324000000000	<b>151</b>	
		KOPER 	118324000000029	<b>161</b>	
• Handdoekbeugel in geanodiseerd aluminium • h = 55 mm; b = 326 mm; d = 57 mm; a = 51 mm					

d = afstand voorkant accessoire tot voorkant radiator

a = afstand accessoire tot radiator

**uit voorraad leverbaar**

**NIVA LAK VERTICAAL:** N1L1 / N2L1

**NIVA INOX VERTICAAL:** N1L1-ES / N2L1-ES

**NIVA SOFT VERTICAAL:** NS1L1 / NS2L1 (zonder geïntegreerd ventiel)

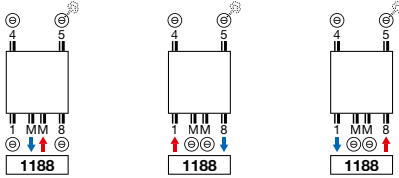

- **Opmerking:** MM met aanvoer rechts.

**NIVA SOFT VERTICAAL:** NS1L1 / NS2L1  
**GEÏNTEGREERD VENTIEL**

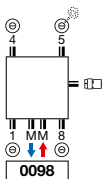

- **Meerprijs:** €102 (zie p. 302)
- **Opmerking:** MM met aanvoer rechts (op deze aansluiting bevindt zich op de achterzijde een stijgbuis).

**NIVA LAK HORIZONTAAL:** NH1L1 / NH2L1 / NH2L2

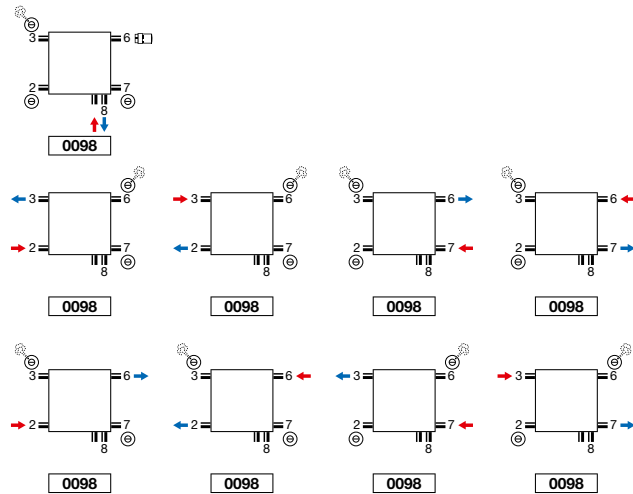

- **Geïntegreerd ventiel:** geen meerprijs (zie p. 302)
- **Thermostaatkop** enkel te gebruiken bij aansluiting op het ventiel (aanvoer links, retour rechts). Andere aansluitingen, vb. 23, thermostaatkop uit de aansluiting 6 nemen. Hier is wel de mogelijkheid om aanvoer en retour te wisselen.

**Opmerking:** het aansluiten van de radiator kan enkel volgens de getoonde aansluiticonen. Voor elke andere aansluitwijze nemen wij geen verantwoordelijkheid.



NIVA LAK VERTICAAL (N1L1, N2L1)

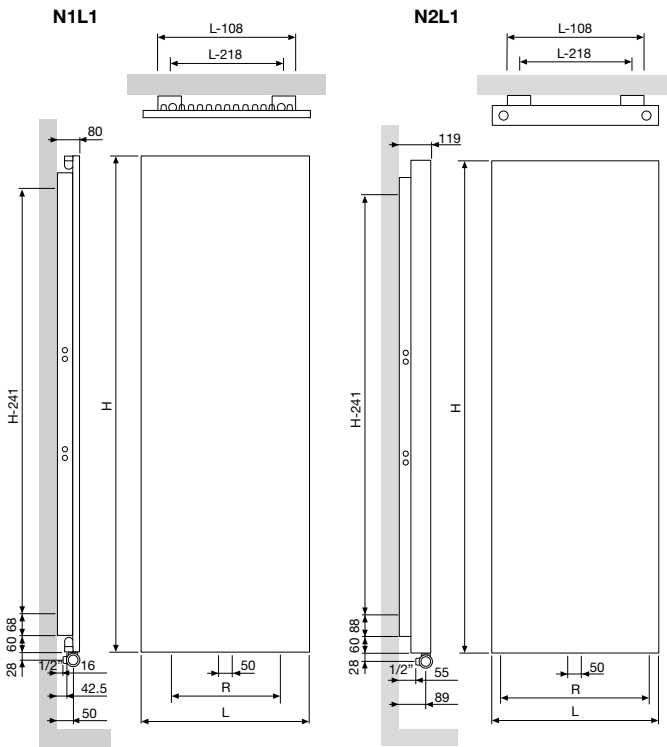

N1L1				
Breedte (L)	420	520	620	720
Hartafstand tussen de onderaansluitingen 18 (R)	200	300	400	500
Hartafstand tussen de ophangingen	L-218	H-241		

N2L1				
Breedte (L)	420	520	620	720
Hartafstand tussen de onderaansluitingen 18 (R)	338	438	538	638
Hartafstand tussen de ophangingen	L-218	H-241		

NIVA INOX VERTICAAL (N1L1-ES, N2L1-ES)

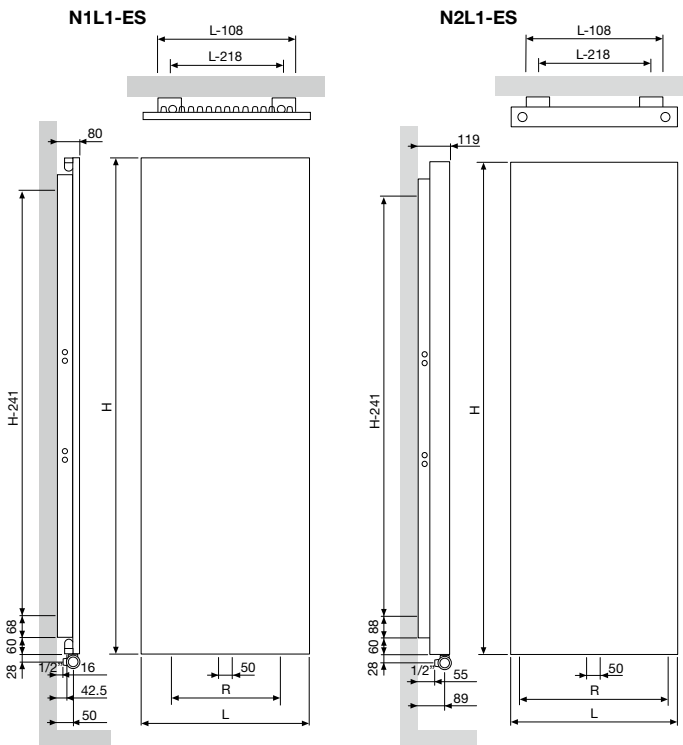

N1L1-ES			
Breedte (L)	520	620	
Hartafstand tussen de onderaansluitingen 18 (R)	300	400	
Hartafstand tussen de ophangingen	L-218	H-241	

N2L1-ES			
Breedte (L)	520	620	
Hartafstand tussen de onderaansluitingen 18 (R)	438	538	
Hartafstand tussen de ophangingen	L-218	H-241	

**NIVA LAK HORIZONTAAL (NH1L1, NH2L1)**

**NH1L1 / NH2L1**

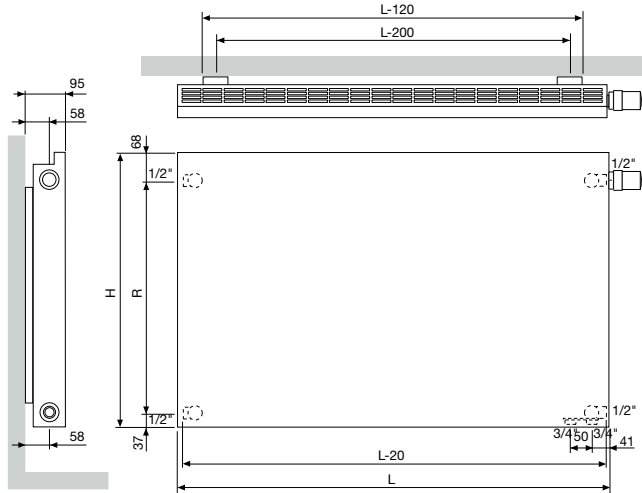

<b>NH1L1</b>			
Hoogte (H)	450	550	650
Hartafstand tussen de zijaansluitingen 23/67 (R)	345	445	545
Hartafstand tussen de ophangingen	L-200		

<b>NH2L1</b>			
Hoogte (H)	550	650	950
Hartafstand tussen de zijaansluitingen 23/67 (R)	445	545	845
Hartafstand tussen de ophangingen	L-200		

**NIVA LAK HORIZONTAAL (NH2L2)**

**NH2L2**

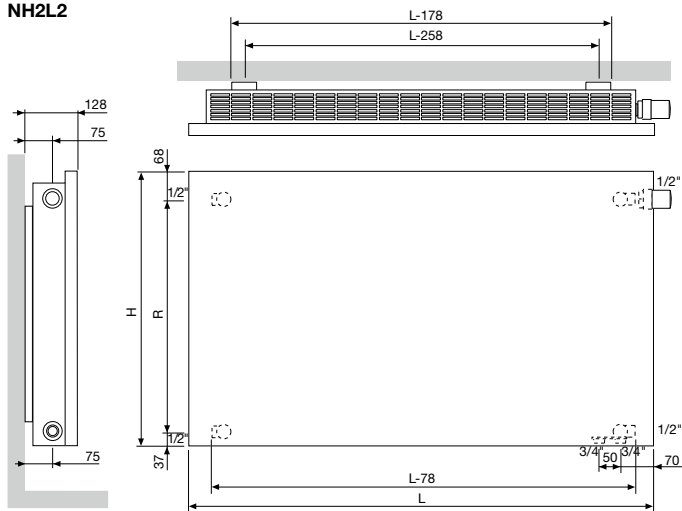

<b>NH2L2</b>			
Hoogte (H)	550	650	950
Hartafstand tussen de zijaansluitingen 23/67 (R)	445	545	845
Hartafstand tussen de ophangingen	L-258		

NIVA SOFT VERTICAAL (NS1L1, NS2L1)

NS1L1

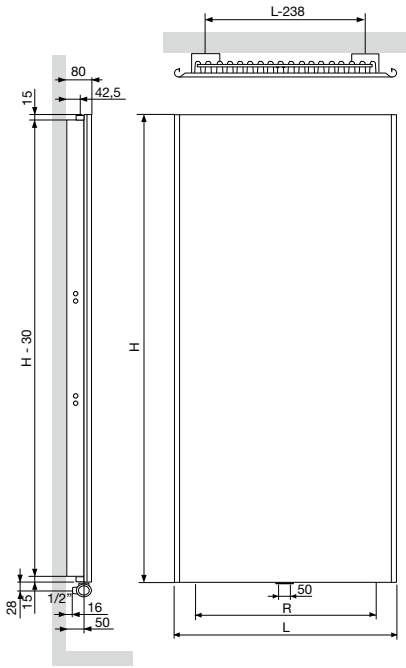

NS2L1

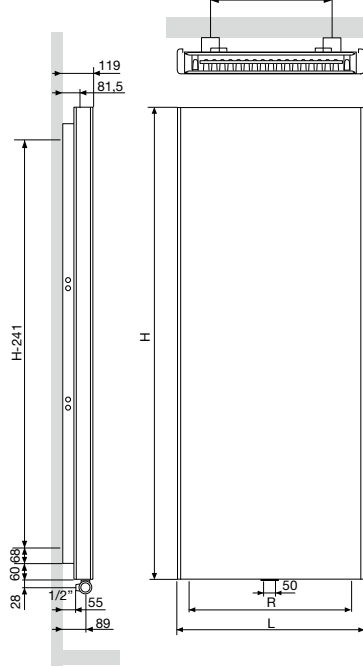

NS1L1

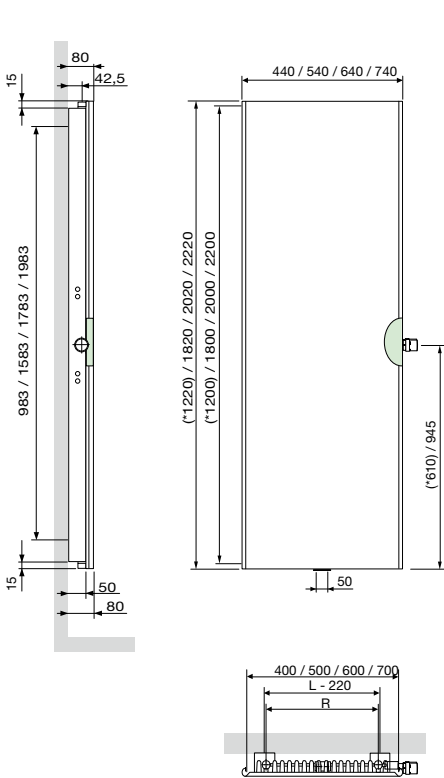

NS2L1

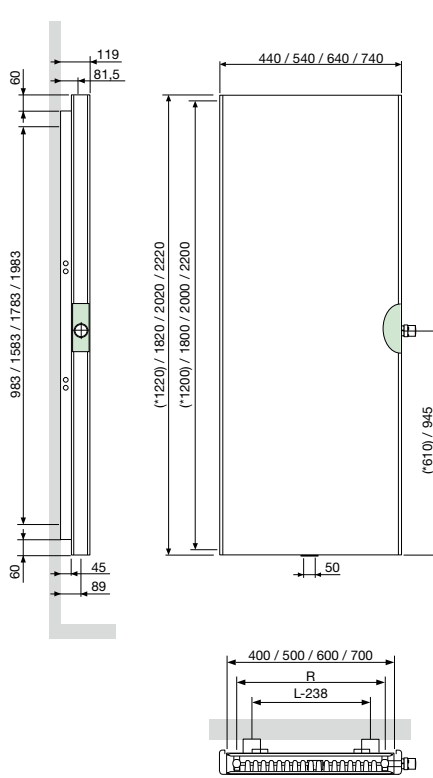

NS1L1

Breedte (L)	440	540	640	740
Hartafstand tussen de onderaansluitingen 18 (R)	200	300	400	500
Hartafstand tussen de ophangingen	L-238	H-241		

NS2L1

Breedte (L)	440	540	640	740
Hartafstand tussen de onderaansluitingen 18 (R)	338	438	538	638
Hartafstand tussen de ophangingen	L-238	H-241		

## TYPES

- Verticaal: Carré Plus (CPVN-PLUS)

## BUIZEN

- Verticaal, vierkant 25 x 25 mm

## COLLECTOREN

- Horizontaal, rond Ø 35 mm

## KLEUREN

- Standaardkleur wit RAL 9016
- Niet verkrijgbaar in kleur Gloss White
- Uitgebreide kleurenkaart zie p. 16

## BEVESTIGINGEN

- Muurbevestigingen standaard

## TECHNISCH

- Weerstandsgelast (onzichtbare lasnaden)
- KTL-grondlaag, poedercoating
- Standaardwerkdruk: 10 bar
- Maximale bedrijfstemperatuur: 110°C

## ELEKTRISCH (zie hoofdstuk elektrische radiatoren)

- ✗ Zuiver elektrische radiator in de fabriek vorgevuld
- ✗ Gemengde radiator

## TECHNISCHE TEKENINGEN

- Zie p. 90

## AANSLUITING

- ✓ Eénpuntsaansluiting voor éénpijpssysteem (radiator speciaal te bestellen) (zie p. 301)
- ✓ Eénpuntsaansluiting voor tweepijpssysteem (radiator speciaal te bestellen) (zie p. 301)
- ✓ Tweepuntsaansluiting voor éénpijpssysteem (aansluiting via de middenaansluiting) (zie p. 300)
- ✓ Tweepuntsaansluiting voor tweepijpssysteem (standaard) (zie p. 300)
- ✗ Geïntegreerd ventiel

## AANBEVOLEN AANSLUITING (1188)

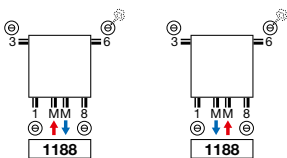

Andere aansluitmogelijkheden, zie p. 89

retour aanvoer



art. nr. 118210300000099

prijs € 155

Koppelingen, zie p. 313

## AANBEVOLEN VOOR BADKAMER IN OPTIE



handdoekbeugel recht (chrom)

art. nr. 118320700000099

prijs € 166

Andere accessoires, zie p. 88



VASCO

STAAL DESIGNRADIATOREN

## OVER CARRÉ PLUS VERTICAAL

### Minimale tussenruimte, maximaal effect

Een icoon in de wereld van de designradiatoren. Speciaal voor de Carré ontwikkelde Vasco een heel nieuw type buis met scherpe hoeken voor een strakker design en met een optimaal warmerendement bij een minimale tussenruimte. De vlakke look creëert een gevoel van rust, versterkt door de weggewerkte, mooi in het geheel geïntegreerde collector. Een veel gelauwerde designradiator, waarvoor Vasco, zoals steeds, ook de passende accessoires ontwikkelde.

# CARRÉ PLUS VERTICAAL (CPVN-PLUS)



CPVN-PLUS

## HOE CARRÉ PLUS VERTICAAL BESTELLEN

Leveringstermijn 15 - 30 werkdagen  
(zonder transportduur)

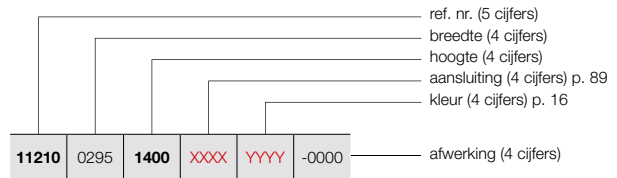

## HOE VOORRAADRADIATOR CARRÉ PLUS VERTICAAL BESTELLEN

Leveringstermijn 5 werkdagen  
(zonder transportduur)

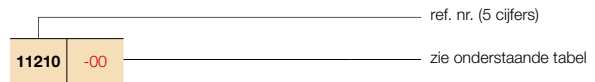

BESTELCODE MAATWERK CARRÉ PLUS VERTICAAL							TECHNISCHE GEGEVENS						STANDAARDKLEUR		ANDERE KLEUREN					
11210	0295	1400	XXXX	YYYY	-0000		buizen	breedte (L mm)	hoogte (H mm)	75/65/20 (Watt)	55/45/20 (Watt)	n-exp.	gewicht (kg)	inhoud (l)	el. weerst. (Watt)	prijs RAL 9016	verkorte ref. nr. RAL 9016 voorraad	prijs kleur	verkorte ref. nr. M301 voorraad	
<b>REF. NR. CARRÉ PLUS VERTICAAL CPVN-PLUS : 11210</b>																				
11210	0295	1400	XXXX	YYYY	-0000		10	295	1400	871	443	1,31	19,70	8,40	-	339	-	390	-	
		1600					10	295	1600	986	505	1,31	21,60	9,40	-	371	-	427	-	
		1800					10	295	1800	1097	559	1,32	23,60	10,50	-	402	11210-01	462	11210-02	
		2000					10	295	2000	1206	614	1,32	26,20	12,00	-	433	-	498	-	
		2200					10	295	2200	1312	672	1,31	28,90	13,50	-	462	-	531	-	
11210	0355	1400	XXXX	YYYY	-0000		12	355	1400	1026	521	1,31	23,16	10,08	-	406	-	467	-	
		1600					12	355	1600	1161	595	1,31	25,44	11,28	-	445	-	512	-	
		1800					12	355	1800	1293	659	1,32	27,72	12,48	-	483	-	555	-	
		2000					12	355	2000	1421	724	1,32	30,96	14,40	-	519	-	597	-	
		2200					12	355	2200	1545	791	1,31	34,08	16,20	-	554	-	637	-	
11210	0415	1400	XXXX	YYYY	-0000		14	415	1400	1179	599	1,31	26,46	11,76	-	474	-	545	-	
		1600					14	415	1600	1334	683	1,31	29,12	13,16	-	520	-	598	-	
		1800					14	415	1800	1485	757	1,32	31,64	14,56	-	563	11210-03	647	11210-04	
		2000					14	415	2000	1632	836	1,31	35,42	16,66	-	606	11210-05	697	-	
		2200					14	415	2200	1775	909	1,31	39,20	18,90	-	647	-	744	-	
11210	0475	1400	XXXX	YYYY	-0000		16	475	1400	1330	676	1,31	29,60	13,28	-	542	-	623	-	
		1600					16	475	1600	1505	771	1,31	32,48	14,88	-	594	-	683	-	
		1800					16	475	1800	1675	853	1,32	35,52	16,48	-	644	-	741	-	
		2000					16	475	2000	1841	943	1,31	39,84	19,04	-	692	-	796	-	
		2200					16	475	2200	2002	1025	1,31	44,00	21,60	-	739	-	850	-	
11210	0535	1400	XXXX	YYYY	-0000		18	535	1400	1478	751	1,31	32,58	14,94	-	610	-	702	-	
		1600					18	535	1600	1673	857	1,31	35,82	16,74	-	668	-	768	-	
		1800					18	535	1800	1862	954	1,31	39,06	18,54	-	724	11210-07	833	11210-08	
		2000					18	535	2000	2046	1048	1,31	43,92	21,42	-	779	11210-09	896	-	
		2200					18	535	2200	2226	1140	1,31	48,78	24,30	-	831	-	956	-	
11210	0595	1400	XXXX	YYYY	-0000		20	595	1400	1625	826	1,31	35,20	16,60	-	677	-	779	-	
		1600					20	595	1600	1839	942	1,31	39,00	18,60	-	742	-	853	-	
		1800					20	595	1800	2047	1048	1,31	42,60	20,40	-	805	11210-11	926	11210-15	
		2000					20	595	2000	2250	1152	1,31	48,00	23,60	-	865	11210-12	995	-	
		2200					20	595	2200	2447	1260	1,30	53,40	27,00	-	924	-	1063	-	
11210	0655	1400	XXXX	YYYY	-0000		22	655	1400	1771	900	1,31	37,84	18,26	-	745	-	857	-	
		1600					22	655	1600	2004	1026	1,31	41,80	20,24	-	817	-	940	-	
		1800					22	655	1800	2231	1143	1,31	45,76	22,44	-	885	-	1018	-	
		2000					22	655	2000	2451	1255	1,31	51,70	25,96	-	952	11210-14	1095	-	
		2200					22	655	2200	2666	1372	1,30	57,64	29,48	-	1016	-	1168	-	
11210	0715	1400	XXXX	YYYY	-0000		24	715	1400	1915	973	1,31	40,32	19,68	-	813	-	935	-	
		1600					24	715	1600	2167	1110	1,31	44,64	22,08	-	891	-	1025	-	
		1800					24	715	1800	2412	1235	1,31	48,96	24,24	-	965	-	1110	-	
		2000					24	715	2000	2651	1365	1,30	55,44	28,32	-	1039	-	1195	-	
		2200					24	715	2200	2883	1484	1,30	61,92	32,16	-	1108	-	1274	-	

CE 13 conform EN442-1: radiatoren en convectoren

Voor de warmteafgifte van andere regimes, kijkt u op p. 308 (correctiefactoren)  
Prijzen in euro (excl. BTW)

## HOE CARRÉ PLUS VERTICAAL BESTELLEN

Leveringstermijn 15 - 30 werkdagen  
(zonder transportduur)

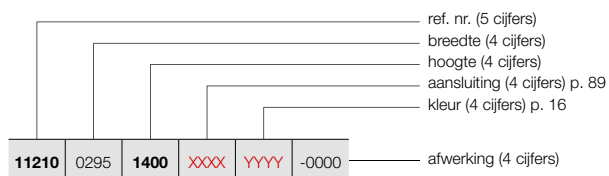

## CARRÉ PLUS VERTICAAL (CPVN-PLUS)



CPVN-PLUS

BESTELCODE MAATWERK CARRÉ PLUS VERTICAAL	TECHNISCHE GEGEVENS									STANDAARDKLEUR		ANDERE KLEUREN						
	buizen	breedte (L mm)	hoogte (H mm)	75/65/20 (Watt)	55/45/20 (Watt)	n-exp.	gewicht (kg)	inhoud (l)	el. weerst. (Watt)	prijs RAL 9016	verkorte ref. nr. RAL 9016 voorraad	prijs kleur	verkorte ref. nr. M301 voorraad					
<b>REF. NR. CARRÉ PLUS VERTICAAL CPVN-PLUS : 11210</b>																		
<b>11210</b>	0775	<b>1400</b>	<b>XXXX</b>	<b>YYYY</b>	-0000	26	775	1400	2058	1046	1,31	42,64	21,32	-	<b>881</b>	-	<b>1013</b>	-
		<b>1600</b>				26	775	1600	2329	1193	1,31	47,32	23,92	-	<b>965</b>	-	<b>1110</b>	-
		<b>1800</b>				26	775	1800	2592	1334	1,30	51,74	26,26	-	<b>1046</b>	-	<b>1203</b>	-
		<b>2000</b>				26	775	2000	2849	1467	1,30	58,76	30,68	-	<b>1125</b>	-	<b>1294</b>	-
		<b>2200</b>				26	775	2200	3098	1595	1,30	65,78	34,84	-	<b>1201</b>	-	<b>1381</b>	-
<b>11210</b>	0895	<b>1400</b>	<b>XXXX</b>	<b>YYYY</b>	-0000	30	895	1400	2341	1189	1,31	46,80	24,60	-	<b>1016</b>	-	<b>1168</b>	-
		<b>1600</b>				30	895	1600	2649	1357	1,31	51,90	27,30	-	<b>1114</b>	-	<b>1281</b>	-
		<b>1800</b>				30	895	1800	2949	1518	1,30	57,00	30,00	-	<b>1207</b>	-	<b>1388</b>	-
		<b>2000</b>				30	895	2000	3240	1668	1,30	65,10	35,10	-	<b>1298</b>	-	<b>1493</b>	-
		<b>2200</b>				30	895	2200	3524	1814	1,30	73,20	40,20	-	<b>1385</b>	-	<b>1593</b>	-

CE 13 conform EN442-1: radiatoren en convectoren

Voor de warmteafgiftes van andere regimes, kijkt u op p. 308 (correctiefactoren)  
Prijzen in euro (excl. BTW)

## CARRÉ VERTICAAL (CPVN2-ZB)



### TYPES

- Twee rijen buizen (CPVN2-ZB)

### BUIZEN

- Verticaal, vierkant 25 x 25 mm

### COLLECTOREN

- Horizontaal, rond Ø 35 mm

### KLEUREN

- Standaardkleur wit RAL 9016
- Niet verkrijgbaar in kleur Gloss White
- Uitgebreide kleurenkaart zie p. 16

### BEVESTIGINGEN

- Muurbevestigingen standaard
- CPVN2-ZB ook verkrijgbaar als vrijstaande opstelling, zie p. 88

### TECHNISCH

- Weerstandsgelast (onzichtbare lasnaden)
- KTL-grondlaag, poedercoating
- Standaardwerkdruk: 10 bar
- Maximale bedrijfstemperatuur: 110°C

### ELEKTRISCH (zie hoofdstuk elektrische radiatoren)

- ✗ Zuiver elektrische radiator in de fabriek voorgevuld
- ✗ Gemengde radiator

### TECHNISCHE TEKENINGEN

- Zie p. 90

### AANSLUITING

- ✓ Eénpuntsaansluiting voor éénpijpssysteem (radiator speciaal te bestellen) (zie p. 301)
- ✓ Eénpuntsaansluiting voor tweepijpssysteem (radiator speciaal te bestellen) (zie p. 301)
- ✓ Tweepuntsaansluiting voor éénpijpssysteem (aansluiting via de middenaansluiting) (zie p. 300)
- ✓ Tweepuntsaansluiting voor tweepijpssysteem (standaard) (zie p. 300)
- ✗ Geïntegreerd ventiel

### OVER CARRÉ VERTICAAL

#### Topdesign met dubbele warmtecapaciteit

De strakke, vlakke look van de Carré Plus, voorzien van een dubbele buizenrij voor een maximale warmteafgifte. De Carré Verticaal designradiator blijft in alles zijn tijdloze, functionele zelf, maar garandeert door die extra capaciteit ook in grotere ruimten een optimaal rendement.

### AANBEVOLEN AANSLUITING (1188)

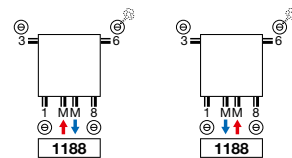

### Andere aansluitmogelijkheden, zie p. 89



art. nr. 118210300000099

**prijs € 155**

Koppelingen, zie p. 313

### AANBEVOLEN VOOR BADKAMER IN OPTIE



handdoekbeugel recht (chrom)

art. nr. 118320700000099

**prijs € 166**

Andere accessoires, zie p. 88



### HOE CARRÉ VERTICAAL BESTELLEN

Leveringstermijn 15 - 30 werkdagen  
(zonder transportduur)

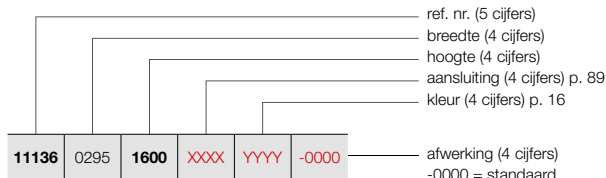

### VRIJSTAANDE OPSTELLING (CPVN2-ZB)

Zie p. 88 voor extra toebehoren.

### HOE VOORRAADRADIATOR CARRÉ VERTICAAL BESTELLEN

Leveringstermijn 5 werkdagen  
(zonder transportduur)

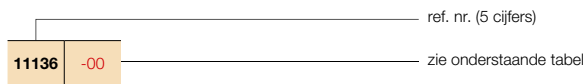

## CARRÉ VERTICAAL (CPVN2-ZB)

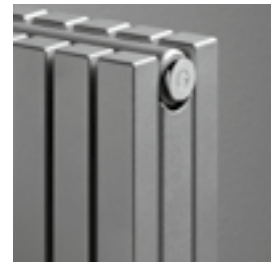

CPVN2-ZB

BESTELCODE MAATWERK CARRÉ VERTICAAL	TECHNISCHE GEGEVENS									STANDAARDKLEUR		ANDERE KLEUREN
	buisen	breedte (L mm)	hoogte (H mm)	75/65/20 (Watt)	55/45/20 (Watt)	n-exp.	gewicht (kg)	inhoud (l)	el. weerst. (Watt)	prijs RAL 9016	verkorte ref. nr. RAL 9016 voorraad	prijs kleur
<b>REF. NR. CARRÉ VERTICAAL CPVN2-ZB : 11136</b>												
<b>11136</b>	0295	<b>1600</b>	<b>XXXX</b>	<b>YYYY</b>	<b>-0000</b>							
		<b>1800</b>								<b>594</b>	-	<b>683</b>
		<b>2000</b>								<b>643</b>	-	<b>739</b>
		<b>2200</b>								<b>693</b>	-	<b>797</b>
		<b>2400</b>								<b>739</b>	-	<b>850</b>
		<b>2600</b>								<b>784</b>	-	<b>902</b>
		<b>2800</b>								<b>829</b>	-	<b>953</b>
		<b>3000</b>								<b>872</b>	-	<b>1003</b>
										<b>914</b>	-	<b>1051</b>
<b>11136</b>	0355	<b>1600</b>	<b>XXXX</b>	<b>YYYY</b>	<b>-0000</b>							
		<b>1800</b>								<b>712</b>	-	<b>819</b>
		<b>2000</b>								<b>773</b>	-	<b>889</b>
		<b>2200</b>								<b>830</b>	-	<b>955</b>
		<b>2400</b>								<b>886</b>	-	<b>1019</b>
		<b>2600</b>								<b>941</b>	-	<b>1082</b>
		<b>2800</b>								<b>994</b>	-	<b>1143</b>
		<b>3000</b>								<b>1046</b>	-	<b>1203</b>
										<b>1098</b>	-	<b>1263</b>
<b>11136</b>	0415	<b>1600</b>	<b>XXXX</b>	<b>YYYY</b>	<b>-0000</b>							
		<b>1800</b>								<b>832</b>	-	<b>957</b>
		<b>2000</b>								<b>901</b>	<b>11136-02</b>	<b>1036</b>
		<b>2200</b>								<b>970</b>	<b>11136-01</b>	<b>1116</b>
		<b>2400</b>								<b>1035</b>	-	<b>1190</b>
		<b>2600</b>								<b>1098</b>	-	<b>1263</b>
		<b>2800</b>								<b>1160</b>	-	<b>1334</b>
		<b>3000</b>								<b>1221</b>	-	<b>1404</b>
										<b>1280</b>	-	<b>1472</b>
<b>11136</b>	0475	<b>1600</b>	<b>XXXX</b>	<b>YYYY</b>	<b>-0000</b>							
		<b>1800</b>								<b>950</b>	-	<b>1093</b>
		<b>2000</b>								<b>1030</b>	-	<b>1185</b>
		<b>2200</b>								<b>1107</b>	-	<b>1273</b>
		<b>2400</b>								<b>1182</b>	-	<b>1359</b>
		<b>2600</b>								<b>1254</b>	-	<b>1442</b>
		<b>2800</b>								<b>1326</b>	-	<b>1525</b>
		<b>3000</b>								<b>1395</b>	-	<b>1604</b>
										<b>1462</b>	-	<b>1681</b>
<b>11136</b>	0535	<b>1600</b>	<b>XXXX</b>	<b>YYYY</b>	<b>-0000</b>							
		<b>1800</b>								<b>1069</b>	-	<b>1229</b>
		<b>2000</b>								<b>1158</b>	<b>11136-03</b>	<b>1332</b>
		<b>2200</b>								<b>1246</b>	<b>11136-07</b>	<b>1433</b>
		<b>2400</b>								<b>1330</b>	-	<b>1530</b>
		<b>2600</b>								<b>1411</b>	-	<b>1623</b>
		<b>2800</b>								<b>1491</b>	-	<b>1715</b>
		<b>3000</b>								<b>1570</b>	-	<b>1806</b>
										<b>1645</b>	-	<b>1892</b>

CE 05 conform EN442-1: radiatoren en convectoren

Voor de warmteafgiftes van andere regimes, kijkt u op p. 308 (correctiefactoren)  
Prijzen in euro (excl. BTW)



# CARRÉ VERTICAAL (CPVN2-ZB)

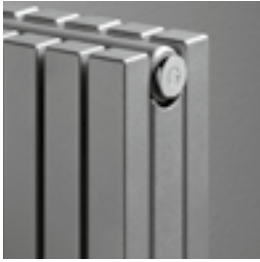

CPVN2-ZB

## HOE CARRÉ VERTICAAL BESTELLEN

Leveringstermijn 15 - 30 werkdagen  
(zonder transportduur)

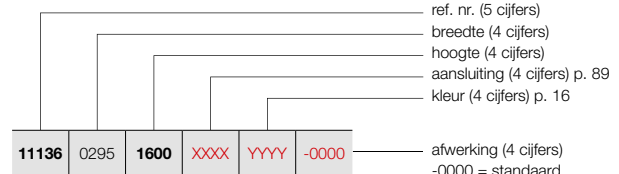

## VRIJSTAANDE OPSTELLING (CPVN2-ZB)

Zie p. 88 voor extra toebehoren.

## HOE VOORRAADRADIATOR CARRÉ VERTICAAL BESTELLEN

Leveringstermijn 5 werkdagen  
(zonder transportduur)

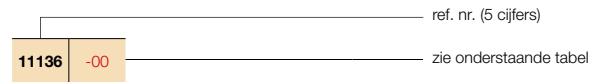

BESTELCODE MAATWERK CARRÉ VERTICAAL							TECHNISCHE GEGEVENS					STANDAARDKLEUR		ANDERE KLEUREN			
REF. NR.	BREEDTE (L mm)	HOOGTE (H mm)	75/65/20 (Watt)	55/45/20 (Watt)	n-exp.	gewicht (kg)	inhoud (l)	el. weerst. (Watt)	prijs RAL 9016	verkorte ref. nr. RAL 9016 voorraad	prijs kleur						
REF. NR. CARRÉ VERTICAAL CPVN2-ZB : 11136																	
11136	0595	1600	XXXX	YYYY	-0000	20	595	1600	2125	1066	1,35	60,40	31,60	-	1187	-	1365
		1800				20	595	1800	2348	1178	1,35	67,60	35,80	-	1288	11136-04	1481
		2000				20	595	2000	2557	1283	1,35	74,60	40,20	-	1384	11136-05	1592
		2200				20	595	2200	2754	1382	1,35	81,20	42,60	-	1478	-	1700
		2400				20	595	2400	2938	1474	1,35	87,60	45,20	-	1568	-	1803
		2600				20	595	2600	3110	1561	1,35	94,20	47,80	-	1658	-	1907
		2800				20	595	2800	3269	1640	1,35	100,60	50,20	-	1744	-	2006
		3000				20	595	3000	3417	1715	1,35	107,20	52,80	-	1829	-	2103
11136	0655	1600	XXXX	YYYY	-0000	22	655	1600	2337	1173	1,35	66,44	34,76	-	1307	-	1503
		1800				22	655	1800	2582	1296	1,35	74,36	39,38	-	1416	-	1628
		2000				22	655	2000	2812	1411	1,35	82,06	44,22	-	1523	11136-13	1751
		2200				22	655	2200	3029	1520	1,35	89,32	46,86	-	1626	-	1870
		2400				22	655	2400	3232	1622	1,35	96,36	49,72	-	1725	-	1984
		2600				22	655	2600	3421	1717	1,35	103,62	52,58	-	1822	-	2095
		2800				22	655	2800	3596	1804	1,35	110,66	55,22	-	1918	-	2206
		3000				22	655	3000	3759	1886	1,35	117,92	58,08	-	2011	-	2313
11136	0715	1600	XXXX	YYYY	-0000	24	715	1600	2550	1280	1,35	72,48	37,92	-	1426	-	1640
		1800				24	715	1800	2817	1413	1,35	81,12	42,96	-	1544	-	1776
		2000				24	715	2000	3069	1540	1,35	89,52	48,24	-	1662	-	1911
		2200				24	715	2200	3305	1658	1,35	97,44	51,12	-	1773	-	2039
		2400				24	715	2400	3526	1769	1,35	105,12	54,24	-	1882	-	2164
		2600				24	715	2600	3732	1873	1,35	113,04	57,36	-	1989	-	2287
		2800				24	715	2800	3923	1968	1,35	120,72	60,24	-	2093	-	2407
		3000				24	715	3000	4101	2058	1,35	128,64	63,36	-	2194	-	2523
11136	0775	1600	XXXX	YYYY	-0000	26	775	1600	2762	1386	1,35	78,52	41,08	-	1544	-	1776
		1800				26	775	1800	3052	1531	1,35	87,88	46,54	-	1674	-	1925
		2000				26	775	2000	3324	1668	1,35	96,98	52,26	-	1800	-	2070
		2200				26	775	2200	3580	1796	1,35	105,56	55,38	-	1922	-	2210
		2400				26	775	2400	3820	1917	1,35	113,88	58,76	-	2040	-	2346
		2600				26	775	2600	4043	2029	1,35	122,46	62,14	-	2154	-	2477
		2800				26	775	2800	4250	2133	1,35	130,78	65,26	-	2267	-	2607
		3000				26	775	3000	4442	2229	1,35	139,36	68,64	-	2376	-	2732
11136	0895	1600	XXXX	YYYY	-0000	30	895	1600	3187	1599	1,35	90,60	47,40	-	1782	-	2049
		1800				30	895	1800	3521	1767	1,35	101,40	53,70	-	1931	-	2221
		2000				30	895	2000	3836	1925	1,35	111,90	60,30	-	2077	11136-19	2389
		2200				30	895	2200	4131	2073	1,35	121,80	63,90	-	2216	-	2548
		2400				30	895	2400	4407	2211	1,35	131,40	67,80	-	2354	-	2707
		2600				30	895	2600	4665	2341	1,35	141,30	71,70	-	2486	-	2859

CE<sub>05</sub> conform EN442-1: radiatoren en convectoren

Voor de warmteafgiftes van andere regimes, kijkt u op p. 308 (correctiefactoren)  
Prijzen in euro (excl. BTW)

## TYPES

- Eén (CPHN1-RO) of twee rijen buizen (CPHN2-RO)

## BUIZEN

- Horizontaal, vierkant 25 x 25 mm

## COLLECTOREN

- Verticaal, rond Ø 35 mm

## KLEUREN

- Standaardkleur wit RAL 9016
- Niet verkrijgbaar in kleur Gloss White
- Uitgebreide kleurenkaart zie p. 16

## SPECIAAL

- CPHN1-RO ook verkrijgbaar als toiletradiator (600 x 415 mm)

## BEVESTIGINGEN

- Muurbevestigingen standaard

## TECHNISCH

- Weerstandsgelast (onzichtbare lasnaden)
- KTL-grondlaag, poedercoating
- Standaardwerkdruk: 10 bar
- Maximale bedrijfstemperatuur: 110°C

## ELEKTRISCH (zie hoofdstuk elektrische radiatoren)

- ✗ Zuiver elektrische radiator in de fabriek vorgevuld
- ✗ Gemengde radiator

## TECHNISCHE TEKENINGEN

- Zie p. 91

## AANSLUITING

- ✓ Eénpuntsaansluiting voor éénpijpssysteem (radiator speciaal te bestellen) (zie p. 301)
- ✓ Eénpuntsaansluiting voor tweepijpssysteem (radiator speciaal te bestellen) (zie p. 301)
- ✗ Tweepuntsaansluiting voor éénpijpssysteem
- ✓ Tweepuntsaansluiting voor tweepijpssysteem (standaard) (zie p. 300)
- ✗ Geïntegreerd ventiel



### AANBEVOLEN AANSLUITING (0018)

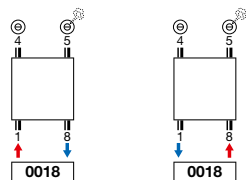

Andere aansluitmogelijkheden, zie p. 89



art. nr. 118210100000099

**prijs € 155**

Koppelingen, zie p. 313

### AANBEVOLEN VOOR BADKAMER IN OPTIE



handdoekbeugel recht (chrom) art. nr. 118320700000099

**prijs € 166**

Andere accessoires, zie p. 88

### OVER CARRÉ HORIZONTAAL

#### Topdesign voor elke warmtebehoefte

De horizontale versie van de Carré, met keuze uit één of twee buizenrijen voor een warmteafgifte op maat in elke ruimte. Een designradiator die ook in de horizontale uitvoering uitblinkt door zijn strak design en zijn vlakke look, nog versterkt door de in het geheel geïntegreerde collector.

# CARRÉ HORIZONTALAAL (CPHN1-RO)

## HOE CARRÉ HORIZONTALAAL BESTELLEN

Leveringstermijn 15 - 30 werkdagen  
(zonder transportduur)

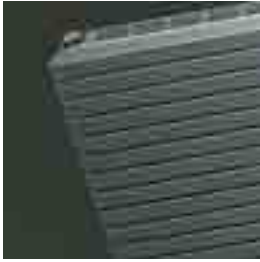

CPHN1-RO

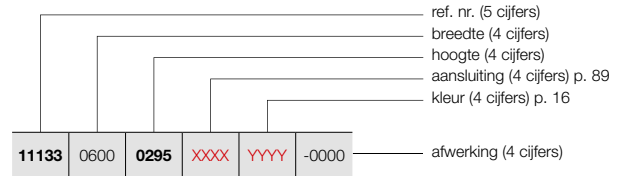

BESTELCODE MAATWERK CARRÉ HORIZONTALAAL							TECHNISCHE GEGEVENS						STANDAARDKLEUR	ANDERE KLEUREN		
REF. NR.	breedte (L mm)	hoogte (H mm)	75/65/20 (Watt)	55/45/20 (Watt)	n-exp.	gewicht (kg)	inhoud (l)	el. weerst. (Watt)	prijs RAL 9016	prijs kleur						
REF. NR. CARRÉ HORIZONTALAAL CPHN1-RO : 11133																
11133	0600	0295	XXXX	YYYY	-0000	10	600	295	221	117	1,25	6,19	2,85	-	162	186
		0355				12	600	355	259	137	1,25	7,41	3,60	-	195	224
		0415				14	600	415	296	156	1,25	8,63	4,35	-	227	261
		0475				16	600	475	333	176	1,25	9,86	5,10	-	260	299
		0535				18	600	535	369	195	1,25	11,08	5,85	-	292	336
		0595				20	600	595	404	213	1,25	12,30	6,60	-	325	374
		0655				22	600	655	439	231	1,26	13,42	6,94	-	357	411
		0775				26	600	775	507	266	1,26	15,67	7,63	-	422	485
		0895				30	600	895	574	302	1,26	17,91	8,31	-	487	560
		11133				0800	0295	XXXX	YYYY	-0000	10	800	295	295	156	1,25
0355	12		800	355	346		183				1,25	9,88	4,80	-	237	273
0415	14		800	415	395		209				1,25	11,51	5,80	-	277	319
0475	16		800	475	444		234				1,25	13,14	6,80	-	316	363
0535	18		800	535	492		260				1,25	14,77	7,80	-	356	409
0595	20		800	595	538		284				1,25	16,40	8,80	-	396	455
0655	22		800	655	585		307				1,26	17,90	9,26	-	435	500
0775	26		800	775	676		355				1,26	20,89	10,17	-	514	591
0895	30		800	895	766		402				1,26	23,88	11,08	-	593	682
11133	1000		0295	XXXX	YYYY		-0000				10	1000	295	369	195	1,25
		0355	12			1000		355	432	228	1,25	12,35	6,00	-	277	319
		0415	14			1000		415	494	261	1,25	14,39	7,25	-	323	371
		0475	16			1000		475	555	293	1,25	16,43	8,50	-	369	424
		0535	18			1000		535	615	325	1,25	18,46	9,75	-	415	477
		0595	20			1000		595	673	355	1,25	20,50	11,00	-	461	530
		0655	22			1000		655	731	384	1,26	22,37	11,57	-	507	583
		0775	26			1000		775	845	444	1,26	26,11	12,71	-	599	689
		0895	30			1000		895	957	503	1,26	29,85	13,85	-	691	795
		11133	1200			0295		XXXX	YYYY	-0000	10	1200	295	443	234	1,25
0355	12			1200	355	518	274				1,25	14,82	7,20	-	313	360
0415	14			1200	415	593	313				1,25	17,27	8,70	-	366	421
0475	16			1200	475	666	352				1,25	19,72	10,20	-	418	481
0535	18			1200	535	738	390				1,25	22,15	11,70	-	470	541
0595	20			1200	595	808	427				1,25	24,60	13,20	-	522	600
0655	22			1200	655	877	461				1,26	26,84	13,88	-	575	661
0775	26			1200	775	1014	533				1,26	31,33	15,25	-	679	781
0895	30			1200	895	1148	603				1,26	35,82	16,62	-	784	902
11133	1400			0295	XXXX	YYYY	-0000				10	1400	295	517	273	1,25
		0355	12	1400				355	605	319	1,25	17,29	8,40	-	348	400
		0415	14	1400				415	692	365	1,25	20,15	10,15	-	406	467
		0475	16	1400				475	777	410	1,25	23,00	11,90	-	464	534
		0535	18	1400				535	861	455	1,25	25,84	13,65	-	523	601
		0595	20	1400				595	942	497	1,25	28,70	15,40	-	581	668
		0655	22	1400				655	1023	537	1,26	31,32	16,20	-	639	735
		0775	26	1400				775	1183	622	1,26	36,55	17,79	-	755	868
		0895	30	1400				895	1340	704	1,26	41,79	19,39	-	871	1002

CE 05 conform EN442-1: radiatoren en convectoren

Voor de warmteafgifte van andere regimes, kijkt u op p. 308 (correctiefactoren)  
Prijzen in euro (excl. BTW)

## HOE CARRÉ HORIZONTAAL BESTELLEN

Leveringstermijn 15 - 30 werkdagen  
(zonder transportduur)

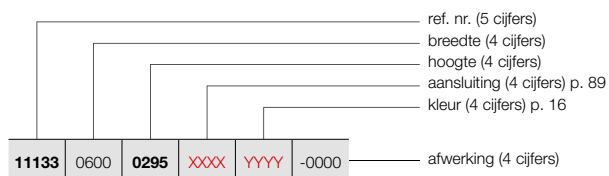

## CARRÉ HORIZONTAAL (CPHN1-RO)

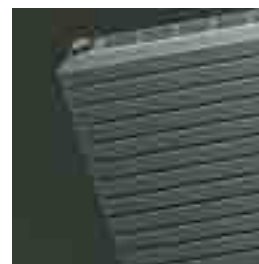

CPHN1-RO

BESTELCODE MAATWERK CARRÉ HORIZONTAAL	TECHNISCHE GEGEVENS									STANDAARDKLEUR	ANDERE KLEUREN					
	buizen	breedte (L mm)	hoogte (H mm)	75/65/20 (Watt)	55/45/20 (Watt)	n-exp.	gewicht (kg)	inhoud (l)	el. weerst. (Watt)	prijs RAL 9016	prijs kleur					
<b>REF. NR. CARRÉ HORIZONTAAL CPHN1-RO : 11133</b>																
<b>11133</b>	1600	<b>0295</b>	<b>XXXX</b>	<b>YYYY</b>	<b>-0000</b>	10	1600	295	590	312	1,25	16,50	7,60	-	<b>318</b>	<b>366</b>
		<b>0355</b>				12	1600	355	691	365	1,25	19,76	9,60	-	<b>382</b>	<b>439</b>
		<b>0415</b>				14	1600	415	790	417	1,25	23,02	11,60	-	<b>445</b>	<b>512</b>
		<b>0475</b>				16	1600	475	888	469	1,25	26,29	13,60	-	<b>509</b>	<b>585</b>
		<b>0535</b>				18	1600	535	984	520	1,25	29,54	15,60	-	<b>573</b>	<b>659</b>
		<b>0595</b>				20	1600	595	1077	569	1,25	32,80	17,60	-	<b>636</b>	<b>731</b>
		<b>0655</b>				22	1600	655	1170	615	1,26	35,79	18,51	-	<b>700</b>	<b>805</b>
		<b>0775</b>				26	1600	775	1352	710	1,26	41,78	20,34	-	<b>827</b>	<b>951</b>
		<b>0895</b>				30	1600	895	1531	804	1,26	47,76	22,16	-	<b>954</b>	<b>1097</b>
		<b>11133</b>				1800	<b>0295</b>	<b>XXXX</b>	<b>YYYY</b>	<b>-0000</b>	10	1800	295	664	351	1,25
<b>0355</b>	12		1800	355	778		411				1,25	22,23	10,80	-	<b>414</b>	<b>476</b>
<b>0415</b>	14		1800	415	889		469				1,25	25,90	13,05	-	<b>483</b>	<b>555</b>
<b>0475</b>	16		1800	475	999		528				1,25	29,57	15,30	-	<b>552</b>	<b>635</b>
<b>0535</b>	18		1800	535	1107		585				1,25	33,23	17,55	-	<b>621</b>	<b>714</b>
<b>0595</b>	20		1800	595	1211		639				1,25	36,90	19,80	-	<b>690</b>	<b>794</b>
<b>0655</b>	22		1800	655	1316		691				1,26	40,27	20,83	-	<b>759</b>	<b>873</b>
<b>0775</b>	26		1800	775	1521		799				1,26	47,00	22,88	-	<b>897</b>	<b>1032</b>
<b>0895</b>	30		1800	895	1723		905				1,26	53,73	24,93	-	<b>1035</b>	<b>1190</b>
<b>11133</b>	2000		<b>0295</b>	<b>XXXX</b>	<b>YYYY</b>		<b>-0000</b>				10	2000	295	738	390	1,25
		<b>0355</b>	12			2000		355	864	456	1,25	24,70	12,00	-	<b>445</b>	<b>512</b>
		<b>0415</b>	14			2000		415	988	522	1,25	28,78	14,50	-	<b>519</b>	<b>597</b>
		<b>0475</b>	16			2000		475	1110	586	1,25	32,86	17,00	-	<b>593</b>	<b>682</b>
		<b>0535</b>	18			2000		535	1230	650	1,25	36,92	19,50	-	<b>667</b>	<b>767</b>
		<b>0595</b>	20			2000		595	1346	711	1,25	41,00	22,00	-	<b>742</b>	<b>853</b>
		<b>0655</b>	22			2000		655	1462	768	1,26	44,74	23,14	-	<b>816</b>	<b>938</b>
		<b>0775</b>	26			2000		775	1690	888	1,26	52,22	25,42	-	<b>964</b>	<b>1109</b>
		<b>0895</b>	30			2000		895	1914	1006	1,26	59,70	27,70	-	<b>1112</b>	<b>1279</b>
		<b>11133</b>	2200			<b>0295</b>		<b>XXXX</b>	<b>YYYY</b>	<b>-0000</b>	10	2200	295	812	429	1,25
<b>0355</b>	12			2200	355	950	502				1,25	27,17	13,20	-	<b>475</b>	<b>546</b>
<b>0415</b>	14			2200	415	1087	574				1,25	31,66	15,95	-	<b>554</b>	<b>637</b>
<b>0475</b>	16			2200	475	1221	645				1,25	36,15	18,70	-	<b>633</b>	<b>728</b>
<b>0535</b>	18			2200	535	1353	714				1,25	40,61	21,45	-	<b>712</b>	<b>819</b>
<b>0595</b>	20			2200	595	1481	782				1,25	45,10	24,20	-	<b>792</b>	<b>911</b>
<b>0655</b>	22			2200	655	1608	845				1,26	49,21	25,45	-	<b>871</b>	<b>1002</b>
<b>0775</b>	26			2200	775	1859	977				1,26	57,44	27,96	-	<b>1029</b>	<b>1183</b>
<b>0895</b>	30			2200	895	2105	1106				1,26	65,67	30,47	-	<b>1187</b>	<b>1365</b>
<b>11133</b>	2400			<b>0295</b>	<b>XXXX</b>	<b>YYYY</b>	<b>-0000</b>				10	2400	295	886	468	1,25
		<b>0355</b>	12	2400				355	1037	548	1,25	29,64	14,40	-	<b>504</b>	<b>580</b>
		<b>0415</b>	14	2400				415	1186	626	1,25	34,54	17,40	-	<b>588</b>	<b>676</b>
		<b>0475</b>	16	2400				475	1332	703	1,25	39,43	20,40	-	<b>672</b>	<b>773</b>
		<b>0535</b>	18	2400				535	1476	779	1,25	44,30	23,40	-	<b>756</b>	<b>869</b>
		<b>0595</b>	20	2400				595	1615	853	1,25	49,20	26,40	-	<b>840</b>	<b>966</b>
		<b>0655</b>	22	2400				655	1754	922	1,26	53,69	27,77	-	<b>924</b>	<b>1063</b>
		<b>0775</b>	26	2400				775	2028	1065	1,26	62,66	30,50	-	<b>1092</b>	<b>1256</b>
		<b>0895</b>	30	2400				895	2297	1207	1,26	71,64	33,24	-	<b>1261</b>	<b>1450</b>

# CARRÉ HORIZONTAAL (CPHN1-RO)

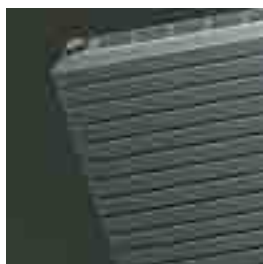

CPHN1-RO

## HOE CARRÉ HORIZONTAAL BESTELLEN

Leveringstermijn 15 - 30 werkdagen  
(zonder transportduur)

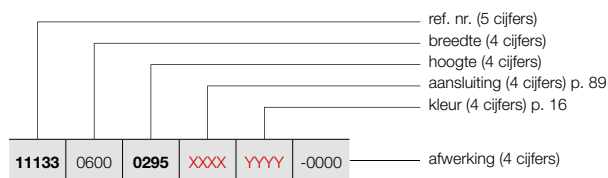

11133	0600	0295	XXXX	YYYY	-0000
-------	------	------	------	------	-------

BESTELCODE MAATWERK CARRÉ HORIZONTAAL							TECHNISCHE GEGEVENS					STANDAARDKLEUR	ANDERE KLEUREN			
REF. NR.	breedte (L mm)	hoogte (H mm)	75/65/20 (Watt)	55/45/20 (Watt)	n-exp.	gewicht (kg)	inhoud (l)	el. weerst. (Watt)	prijs RAL 9016	prijs kleur						
REF. NR. CARRÉ HORIZONTAAL CPHN1-RO : 11133																
11133	2600	0295	XXXX	YYYY	-0000	10	2600	295	959	506	1,25	26,81	12,35	-	444	511
		0355				12	2600	355	1123	593	1,25	32,11	15,60	-	533	613
		0415				14	2600	415	1284	678	1,25	37,41	18,85	-	621	714
		0475				16	2600	475	1443	762	1,25	42,72	22,10	-	710	817
		0535				18	2600	535	1599	844	1,25	48,00	25,35	-	799	919
		0595				20	2600	595	1750	924	1,25	53,30	28,60	-	888	1021
		0655				22	2600	655	1901	999	1,26	58,16	30,08	-	977	1124
		0775				26	2600	775	2197	1154	1,26	67,89	33,05	-	1154	1327
		0895				30	2600	895	2488	1307	1,26	77,61	36,01	-	1332	1532
11133	2800	0295	XXXX	YYYY	-0000	10	2800	295	1033	545	1,25	28,87	13,30	-	467	537
		0355				12	2800	355	1210	639	1,25	34,58	16,80	-	560	644
		0415				14	2800	415	1383	730	1,25	40,29	20,30	-	654	752
		0475				16	2800	475	1554	821	1,25	46,00	23,80	-	747	859
		0535				18	2800	535	1722	909	1,25	51,69	27,30	-	841	967
		0595				20	2800	595	1884	995	1,25	57,40	30,80	-	934	1074
		0655				22	2800	655	2047	1075	1,26	62,64	32,40	-	1028	1182
		0775				26	2800	775	2366	1243	1,26	73,11	35,59	-	1214	1396
		0895				30	2800	895	2680	1408	1,26	83,58	38,78	-	1401	1611
11133	3000	0295	XXXX	YYYY	-0000	10	3000	295	1107	585	1,25	30,93	14,25	-	490	564
		0355				12	3000	355	1296	684	1,25	37,05	18,00	-	588	676
		0415				14	3000	415	1482	783	1,25	43,17	21,75	-	686	789
		0475				16	3000	475	1665	879	1,25	49,29	25,50	-	783	900
		0535				18	3000	535	1845	974	1,25	55,38	29,25	-	881	1013
		0595				20	3000	595	2019	1066	1,25	61,50	33,00	-	979	1126
		0655				22	3000	655	2193	1152	1,26	67,11	34,71	-	1077	1239
		0775				26	3000	775	2535	1332	1,26	78,33	38,13	-	1273	1464
		0895				30	3000	895	2871	1508	1,26	89,55	41,55	-	1469	1689

CE05 conform EN442-1: radiatoren en convectoren

Voor de warmteafgiftes van andere regimes, kijkt u op p. 308 (correctiefactoren)  
 Prijzen in euro (excl. BTW)

## HOE CARRÉ HORIZONTAAL BESTELLEN

Leveringstermijn 15 - 30 werkdagen  
(zonder transportduur)

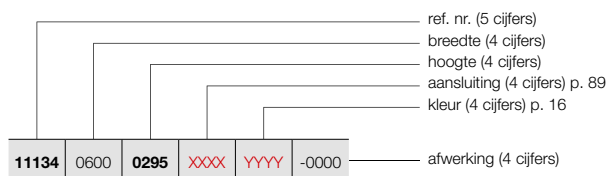

11134 0600 0295 XXXX YYYY -0000

## CARRÉ HORIZONTAAL (CPHN2-RO)



CPHN2-RO

BESTELCODE MAATWERK CARRÉ HORIZONTAAL	TECHNISCHE GEGEVENS									STANDAARDKLEUR	ANDERE KLEUREN
	buizen	breedte (L mm)	hoogte (H mm)	75/65/20 (Watt)	55/45/20 (Watt)	n-exp.	gewicht (kg)	inhoud (l)	el. weerst. (Watt)	prijs RAL 9016	prijs kleur
<b>REF. NR. CARRÉ HORIZONTAAL CPHN2-RO : 11134</b>											
11134 0600 0295 XXXX YYYY -0000	10	600	295	377	200	1,24	11,94	6,06	-	316	363
	12	600	355	459	242	1,25	14,26	7,27	-	380	437
	14	600	415	539	282	1,27	16,57	8,48	-	443	509
	16	600	475	617	321	1,28	18,89	9,70	-	507	583
	18	600	535	693	359	1,29	21,20	10,91	-	569	654
	20	600	595	766	394	1,30	23,52	12,12	-	634	729
	22	600	655	836	430	1,30	25,85	13,39	-	696	800
	26	600	775	967	498	1,30	30,50	15,94	-	823	946
	30	600	895	1087	560	1,30	35,16	18,48	-	950	1093
	11134 0800 0295 XXXX YYYY -0000	10	800	295	503	267	1,24	15,92	8,08	-	386
12		800	355	612	323	1,25	19,01	9,70	-	462	531
14		800	415	719	376	1,27	22,10	11,31	-	540	621
16		800	475	823	428	1,28	25,18	12,93	-	616	708
18		800	535	924	478	1,29	28,27	14,54	-	694	798
20		800	595	1021	526	1,30	31,36	16,16	-	772	888
22		800	655	1114	573	1,30	34,46	17,86	-	848	975
26		800	775	1290	664	1,30	40,67	21,25	-	1002	1152
30		800	895	1449	746	1,30	46,88	24,64	-	1156	1329
11134 1000 0295 XXXX YYYY -0000		10	1000	295	629	334	1,24	19,90	10,10	-	449
	12	1000	355	765	404	1,25	23,76	12,12	-	540	621
	14	1000	415	899	470	1,27	27,62	14,14	-	630	725
	16	1000	475	1029	535	1,28	31,48	16,16	-	720	828
	18	1000	535	1155	598	1,29	35,34	18,18	-	809	930
	20	1000	595	1276	657	1,30	39,20	20,20	-	899	1034
	22	1000	655	1393	717	1,30	43,08	22,32	-	989	1137
	26	1000	775	1612	830	1,30	50,84	26,56	-	1168	1343
	30	1000	895	1811	932	1,30	58,60	30,80	-	1347	1549
	11134 1200 0295 XXXX YYYY -0000	10	1200	295	755	401	1,24	23,88	12,12	-	509
12		1200	355	918	485	1,25	28,51	14,54	-	610	702
14		1200	415	1079	564	1,27	33,14	16,97	-	714	821
16		1200	475	1235	642	1,28	37,78	19,39	-	815	937
18		1200	535	1386	717	1,29	42,41	21,82	-	917	1055
20		1200	595	1531	788	1,30	47,04	24,24	-	1018	1171
22		1200	655	1672	861	1,30	51,70	26,78	-	1121	1289
26		1200	775	1934	996	1,30	61,01	31,87	-	1324	1523
30		1200	895	2173	1119	1,30	70,32	36,96	-	1529	1758
11134 1400 0295 XXXX YYYY -0000		10	1400	295	881	468	1,24	27,86	14,14	-	566
	12	1400	355	1071	566	1,25	33,26	16,97	-	679	781
	14	1400	415	1259	658	1,27	38,67	19,80	-	792	911
	16	1400	475	1441	749	1,28	44,07	22,62	-	905	1041
	18	1400	535	1617	837	1,29	49,48	25,45	-	1020	1173
	20	1400	595	1786	919	1,30	54,88	28,28	-	1133	1303
	22	1400	655	1950	1004	1,30	60,31	31,25	-	1246	1433
	26	1400	775	2257	1162	1,30	71,18	37,18	-	1472	1693
	30	1400	895	2535	1305	1,30	82,04	43,12	-	1698	1953

CE 05 conform EN442-1: radiatoren en convectoren

Voor de warmteafgiftes van andere regimes, kijkt u op p. 308 (correctiefactoren)  
Prijzen in euro (excl. BTW)

# CARRÉ HORIZONTALAAL (CPHN2-RO)

## HOE CARRÉ HORIZONTALAAL BESTELLEN

Leveringstermijn 15 - 30 werkdagen  
(zonder transportduur)

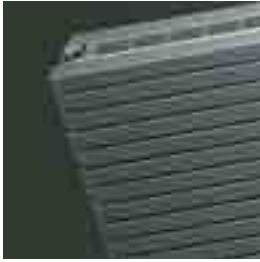

CPHN2-RO

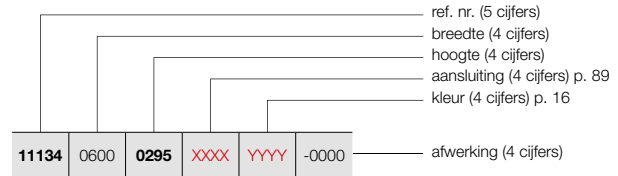

BESTELCODE MAATWERK CARRÉ HORIZONTALAAL							TECHNISCHE GEGEVENS					STANDAARDKLEUR	ANDERE KLEUREN			
REF. NR.	breedte (L mm)	hoogte (H mm)	75/65/20 (Watt)	55/45/20 (Watt)	n-exp.	gewicht (kg)	inhoud (l)	el. weerst. (Watt)	prijs RAL 9016	prijs kleur						
REF. NR. CARRÉ HORIZONTALAAL CPHN2-RO : 11134																
11134	1600	0295	XXXX	YYYY	-0000	10	1600	295	1006	534	1,24	31,84	16,16	-	620	713
		0355				12	1600	355	1224	646	1,25	38,02	19,39	-	745	857
		0415				14	1600	415	1438	752	1,27	44,19	22,62	-	868	998
		0475				16	1600	475	1646	856	1,28	50,37	25,86	-	993	1142
		0535				18	1600	535	1848	956	1,29	56,54	29,09	-	1117	1285
		0595				20	1600	595	2042	1051	1,30	62,72	32,32	-	1240	1426
		0655				22	1600	655	2229	1147	1,30	68,93	35,71	-	1365	1570
		0775				26	1600	775	2579	1328	1,30	81,34	42,50	-	1613	1855
		0895				30	1600	895	2898	1492	1,30	93,76	49,28	-	1860	2139
		11134				1800	0295	XXXX	YYYY	-0000	10	1800	295	1132	601	1,24
0355	12		1800	355	1377		727				1,25	42,77	21,82	-	807	928
0415	14		1800	415	1618		846				1,27	49,72	25,45	-	942	1083
0475	16		1800	475	1852		963				1,28	56,66	29,09	-	1076	1237
0535	18		1800	535	2079		1076				1,29	63,61	32,72	-	1211	1393
0595	20		1800	595	2297		1182				1,30	70,56	36,36	-	1346	1548
0655	22		1800	655	2507		1290				1,30	77,54	40,18	-	1480	1702
0775	26		1800	775	2902		1494				1,30	91,51	47,81	-	1749	2011
0895	30		1800	895	3260		1678				1,30	105,48	55,44	-	2018	2321
11134	2000		0295	XXXX	YYYY		-0000				10	2000	295	1258	668	1,24
		0355	12			2000		355	1530	808	1,25	47,52	24,24	-	868	998
		0415	14			2000		415	1798	940	1,27	55,24	28,28	-	1012	1164
		0475	16			2000		475	2058	1070	1,28	62,96	32,32	-	1156	1329
		0535	18			2000		535	2310	1195	1,29	70,68	36,36	-	1301	1496
		0595	20			2000		595	2552	1314	1,30	78,40	40,40	-	1447	1664
		0655	22			2000		655	2786	1434	1,30	86,16	44,64	-	1591	1830
		0775	26			2000		775	3224	1660	1,30	101,68	53,12	-	1880	2162
		0895	30			2000		895	3622	1864	1,30	117,20	61,60	-	2168	2493
		11134	2200			0295		XXXX	YYYY	-0000	10	2200	295	1384	735	1,24
0355	12			2200	355	1683	889				1,25	52,27	26,66	-	926	1065
0415	14			2200	415	1978	1034				1,27	60,76	31,11	-	1080	1242
0475	16			2200	475	2264	1177				1,28	69,26	35,55	-	1234	1419
0535	18			2200	535	2541	1315				1,29	77,75	40,00	-	1388	1596
0595	20			2200	595	2807	1445				1,30	86,24	44,44	-	1544	1776
0655	22			2200	655	3065	1578				1,30	94,78	49,10	-	1698	1953
0775	26			2200	775	3546	1825				1,30	111,85	58,43	-	2007	2308
0895	30			2200	895	3984	2051				1,30	128,92	67,76	-	2315	2662
11134	2400			0295	XXXX	YYYY	-0000				10	2400	295	1510	801	1,24
		0355	12	2400				355	1836	970	1,25	57,02	29,09	-	983	1130
		0415	14	2400				415	2158	1128	1,27	66,29	33,94	-	1147	1319
		0475	16	2400				475	2470	1284	1,28	75,55	38,78	-	1310	1507
		0535	18	2400				535	2772	1434	1,29	84,82	43,63	-	1474	1695
		0595	20	2400				595	3062	1576	1,30	94,08	48,48	-	1638	1884
		0655	22	2400				655	3343	1721	1,30	103,39	53,57	-	1802	2072
		0775	26	2400				775	3869	1992	1,30	122,02	63,74	-	2129	2448

CE<sub>05</sub> conform EN442-1: radiatoren en convectoren

Voor de warmteafgiftes van andere regimes, kijkt u op p. 308 (correctiefactoren)  
Prijzen in euro (excl. BTW)

## HOE CARRÉ HORIZONTAAL BESTELLEN

Leveringstermijn 15 - 30 werkdagen  
(zonder transportduur)

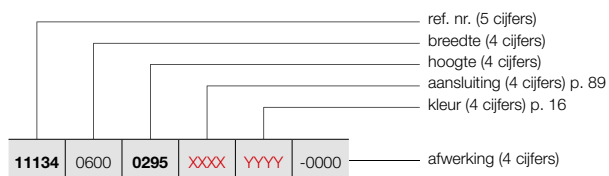

11134	0600	0295	XXXX	YYYY	-0000
-------	------	------	------	------	-------

## CARRÉ HORIZONTAAL (CPHN2-RO)



CPHN2-RO

BESTELCODE MAATWERK CARRÉ HORIZONTAAL	TECHNISCHE GEGEVENS									STANDAARDKLEUR	ANDERE KLEUREN					
	buizen	breedte (L mm)	hoogte (H mm)	75/65/20 (Watt)	55/45/20 (Watt)	n-exp.	gewicht (kg)	inhoud (l)	el. weerst. (Watt)	prijs RAL 9016	prijs kleur					
<b>REF. NR. CARRÉ HORIZONTAAL CPHN2-RO : 11134</b>																
11134	2600	0295	XXXX	YYYY	-0000	10	2600	295	1635	868	1,24	51,74	26,26	-	866	996
		0355				12	2600	355	1989	1050	1,25	61,78	31,51	-	1039	1195
		0415				14	2600	415	2337	1222	1,27	71,81	36,76	-	1211	1393
		0475				16	2600	475	2675	1391	1,28	81,85	42,02	-	1385	1593
		0535				18	2600	535	3003	1554	1,29	91,88	47,27	-	1558	1792
		0595				20	2600	595	3318	1708	1,30	101,92	52,52	-	1732	1992
		0655				22	2600	655	3622	1864	1,30	112,01	58,03	-	1905	2191
		0775				26	2600	775	4191	2157	1,30	132,18	69,06	-	2250	2588
11134	2800	0295	XXXX	YYYY	-0000	10	2800	295	1761	935	1,24	55,72	28,28	-	911	1048
		0355				12	2800	355	2142	1131	1,25	66,53	33,94	-	1092	1256
		0415				14	2800	415	2517	1316	1,27	77,34	39,59	-	1275	1466
		0475				16	2800	475	2881	1498	1,28	88,14	45,25	-	1457	1676
		0535				18	2800	535	3234	1673	1,29	98,95	50,90	-	1640	1886
		0595				20	2800	595	3573	1839	1,30	109,76	56,56	-	1821	2094
		0655				22	2800	655	3900	2008	1,30	120,62	62,50	-	2005	2306
		11134				3000	0295	XXXX	YYYY	-0000	10	3000	295	1887	1002	1,24
0355	12		3000	355	2295		1212				1,25	71,28	36,36	-	1147	1319
0415	14		3000	415	2697		1410				1,27	82,86	42,42	-	1338	1539
0475	16		3000	475	3087		1605				1,28	94,44	48,48	-	1527	1756
0535	18		3000	535	3465		1793				1,29	106,02	54,54	-	1718	1976
0595	20		3000	595	3828		1970				1,30	117,60	60,60	-	1909	2195
0655	22		3000	655	4179		2151				1,30	129,24	66,96	-	2100	2415

CE 05 conform EN442-1: radiatoren en convectoren

Voor de warmteafgiftes van andere regimes, kijkt u op p. 308 (correctiefactoren)  
Prijzen in euro (excl. BTW)



## CARRÉ BAD (CB)



### BUIZEN

- Horizontaal, vierkant 25 x 25 mm

### COLLECTOREN

- Verticaal, rond Ø 35 mm

### KLEUREN

- Standaardkleur wit RAL 9016
- Niet verkrijgbaar in kleur Gloss White
- Uitgebreide kleurenkaart zie p. 16

### BEVESTIGINGEN

- Muurbevestigingen standaard

### TECHNISCH

- Weerstandsgelast (onzichtbare lasnaden)
- KTL-grondlaag, poedercoating
- Standaardwerkdruk: 10 bar
- Maximale bedrijfstemperatuur: 110°C

### ELEKTRISCH (zie hoofdstuk elektrische radiatoren)

- ✓ Zuiver elektrische radiator in de fabriek voorgevuld
- ✓ Gemengde radiator

### TECHNISCHE TEKENINGEN

- Zie p. 91

### AANSLUITING

- ✗ Eénpuntsaansluiting voor éénpijpsysteem
  - ✗ Eénpuntsaansluiting voor tweepijpsysteem
  - ✓ Tweepuntsaansluiting voor éénpijpsysteem (aansluiting via de middenaansluiting) (zie p. 300)
  - ✓ Tweepuntsaansluiting voor tweepijpsysteem (standaard) (zie p. 300)
  - ✗ Geïntegreerd ventiel
- Voor bovenaansluiting 45, 54 dient men een speciale stromingsbuis bij te bestellen die in de retour geplaatst dient te worden, zie p. 303.

## OVER CARRÉ BAD

### Een badkamerradiator uit één stuk

De Carré Bad, nu ook met middenaansluiting, blijft charmeren door zijn pure, architecturale vormgeving en zijn opvallende eenvoud. Alles aan deze badkamerradiator is uniek en onovertroffen: de perfecte eenvormigheid, de verrassend hoge warmteafgifte en de superieure techniciteit. Want achter het ultraminimalistisch design schuilt heel wat technologisch vernuft dat tot in de kleinste details is doorgevoerd.

### AANBEVOLEN AANSLUITING (1188)

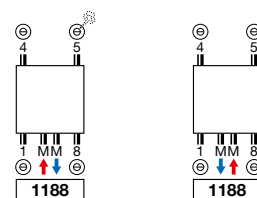

Andere aansluitmogelijkheden, zie p. 89



art. nr. 118210300000099  
prijs € 155  
Koppelingen, zie p. 313

### AANBEVOLEN VOOR BADKAMER IN OPTIE



handdoekbeugel recht (chrom) art. nr. 118320700000099  
prijs € 166

Andere accessoires, zie p. 88



### HOE CARRÉ BAD BESTELLEN

Leveringstermijn 15 - 30 werkdagen  
(zonder transportduur)

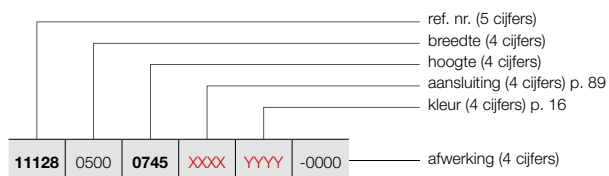

### CARRÉ BAD (CB)



CB

### HOE VOORRAADRADIATOR CARRÉ BAD BESTELLEN

Leveringstermijn 5 werkdagen  
(zonder transportduur)

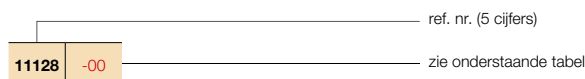

BESTELCODE MAATWERK CARRÉ BAD	TECHNISCHE GEGEVENS									STANDAARDKLEUR		ANDERE KLEUREN						
	buizen	breedte (L mm)	hoogte (H mm)	75/65/20 (Watt)	55/45/20 (Watt)	n-exp.	gewicht (kg)	inhoud (l)	el. weerst. (Watt)	prijs RAL 9016	verkorte ref. nr. RAL 9016 voorraad	prijs kleur	verkorte ref. nr. M301 voorraad					
<b>REF. NR. CARRÉ BAD CB : 11128</b>																		
11128	0500	0745	XXXX	YYYY	-0000	21	500	745	438	235	1,22	12,80	6,20	300	454	-	522	-
		1375				40	500	1375	747	399	1,23	22,95	11,80	750	691	11128-12	795	11128-08
		1735				50	500	1735	925	493	1,23	29,00	14,80	1000	817	11128-21	940	11128-17
11128	0600	0745	XXXX	YYYY	-0000	21	600	745	521	278	1,23	14,35	7,30	500	477	-	549	-
		1375				40	600	1375	886	473	1,23	27,35	13,90	750	726	11128-15	835	11128-01
		1735				50	600	1735	1089	581	1,23	33,35	17,20	1000	861	11128-24	990	11128-04

CE 05 conform EN442-1: radiatoren en convectoren

Voor de warmteafgiftes van andere regimes, kijkt u op p. 308 (correctiefactoren)  
Prijzen in euro (excl. BTW)

## CARRÉ HALFROND (CR-O)



### BUIZEN

- Verticaal, vierkant 25 x 25 mm

### COLLECTOREN

- Horizontaal, rond Ø 35 mm

### KLEUREN

- Standaardkleur wit RAL 9016
- Niet verkrijgbaar in kleur Gloss White
- Uitgebreide kleurenkaart zie p. 16

### SPECIAAL

- 2 uitvoeringen mogelijk, R150 en R190

### BEVESTIGINGEN

- Muurbevestigingen standaard

### TECHNISCH

- Weerstandsgelast (onzichtbare lasnaden)
- KTL-grondlaag, poedercoating
- Standaardwerkdruk: 10 bar
- Maximale bedrijfstemperatuur: 110°C

### ELEKTRISCH (zie hoofdstuk elektrische radiatoren)

- ✗ Zuiver elektrische radiator in de fabriek voorgevuld
- ✗ Gemengde radiator

### TECHNISCHE TEKENINGEN

- Zie p. 92

### AANSLUITING

- ✗ Eénpuntsaansluiting voor éénpijpsysteem
- ✗ Eénpuntsaansluiting voor tweepijpsysteem
- ✗ Tweepuntsaansluiting voor éénpijpsysteem
- ✓ Tweepuntsaansluiting voor tweepijpsysteem (standaard) (zie p. 300)
- ✗ Geïntegreerd ventiel

## OVER CARRÉ HALFROND

### Ritmisch, speels, decoratief

De strakke, vlakke structuur van de Carré designradiator verrast ook in de halfronde versie door zijn simpel, ritmisch lijnenspel. De Carré Half rond verfraait de woonomgeving door zijn speelse vormgeving en staat borg voor een gelijkmatig verdeeld verwarmingscomfort. Met halfronde handdoekbeugel in optie.

### AANBEVOLEN AANSLUITING (0018)

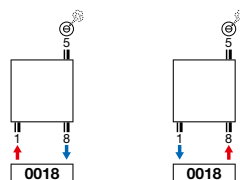

art. nr. 118210100000099

**prijs € 155**

Koppelingen, zie p. 313

### AANBEVOLEN VOOR BADKAMER IN OPTIE



handdoekbeugel rond (aluminium)  
art. nr. 118321000000000 (350 mm)  
**prijs € 201**

**Andere accessoires, zie p. 88**



### HOE CARRÉ HALFROND BESTELLEN

Leveringstermijn 15 - 30 werkdagen  
(zonder transportduur)

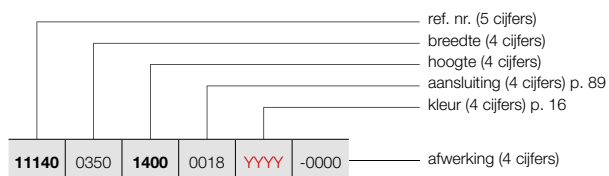

11140	0350	1400	0018	YYYY	-0000
-------	------	------	------	------	-------

### CARRÉ HALFROND (CR-O)



CR-O

### HOE VOORRAADRADIATOR CARRÉ HALFROND BESTELLEN

Leveringstermijn 5 werkdagen  
(zonder transportduur)

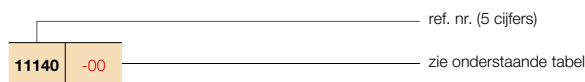

11140	-00
-------	-----

BESTELCODE MAATWERK CARRÉ HALFROND	TECHNISCHE GEGEVENS									STANDAARDKLEUR		ANDERE KLEUREN						
	buizen	breedte (L mm)	hoogte (H mm)	75/65/20 (Watt)	55/45/20 (Watt)	n-exp.	gewicht (kg)	inhoud (l)	el. weerst. (Watt)	prijs RAL 9016	verkorte ref. nr. RAL 9016 voorraad	prijs kleur	verkorte ref. nr. M301 voorraad					
<b>REF. NR. CARRÉ HALFROND CR-O : 11140</b>																		
11140	0350	1400	0018	YYYY	-0000	16	350	1400	1225	640	1,27	22,70	12,00	-	675	-	776	-
		16				350	1800	1528	799	1,27	27,85	15,20	-	802	11140-06	922	11140-01	
		16				350	2000	1676	876	1,27	31,18	16,85	-	863	-	992	-	
		16				350	2200	1823	953	1,27	34,50	18,50	-	921	-	1059	-	
11140	0430	1400	0018	YYYY	-0000	20	430	1400	1588	834	1,26	28,45	15,05	-	844	-	971	-
		20				430	1800	1981	1041	1,26	35,60	18,95	-	1003	-	1153	-	
		20				430	2000	2174	1142	1,26	39,83	21,05	-	1078	-	1240	-	
		20				430	2200	2364	1242	1,26	44,05	23,15	-	1151	-	1324	-	

CE 05 conform EN442-1: radiatoren en convectoren

Voor de warmteafgiftes van andere regimes, kijkt u op p. 308 (correctiefactoren)  
 Prijzen in euro (excl. BTW)

## CARRÉ KWARTROND (CR-A)



### BUIZEN

- Verticaal, vierkant 25 x 25 mm

### COLLECTOREN

- Horizontaal, rond Ø 35 mm

### KLEUREN

- Standaardkleur wit RAL 9016
- Niet verkrijgbaar in kleur Gloss White
- Uitgebreide kleurenkaart zie p. 16

### SPECIAAL

- 2 uitvoeringen mogelijk, R150 en R190

### BEVESTIGINGEN

- Muurbevestigingen standaard

### TECHNISCH

- Weerstandsgelast (onzichtbare lasnaden)
- KTL-grondlaag, poedercoating
- Standaardwerkdruk: 10 bar
- Maximale bedrijfstemperatuur: 110°C

### ELEKTRISCH (zie hoofdstuk elektrische radiatoren)

- ✗ Zuiver elektrische radiator in de fabriek gevuld
- ✗ Gemengde radiator

### TECHNISCHE TEKENINGEN

- Zie p. 92

### AANSLUITING

- ✗ Eénpuntsaansluiting voor éénpijpssysteem
- ✗ Eénpuntsaansluiting voor tweepijpssysteem
- ✗ Tweepuntsaansluiting voor éénpijpssysteem
- ✓ Tweepuntsaansluiting voor tweepijpssysteem (standaard) (zie p. 300)
- ✗ Geïntegreerd ventiel

### OVER CARRÉ KWARTROND

#### Verfraait en verwarmt in één beweging

De Carré Kwartrond onderscheidt zich door zijn fraai gestyleerd, decoratief profiel. Een designradiator die zowel rust als leven brengt in de woonomgeving, met de geruststellende zekerheid van een snelle verwarming op maat. Met kwartronde handdoekbeugel in optie voor de badkamer.

### AANBEVOLEN AANSLUITING (0018)

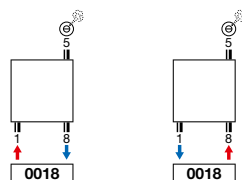

art. nr. 118210100000099

**prijs € 155**

Koppelingen, zie p. 313

### AANBEVOLEN VOOR BADKAMER IN OPTIE



handdoekbeugel rond (aluminium)  
art. nr. 118320800000000 (244 mm)  
**prijs € 201**

**Andere accessoires, zie p. 88**



### HOE CARRÉ KWARTROND BESTELLEN

Leveringstermijn 15 - 30 werkdagen  
(zonder transportduur)

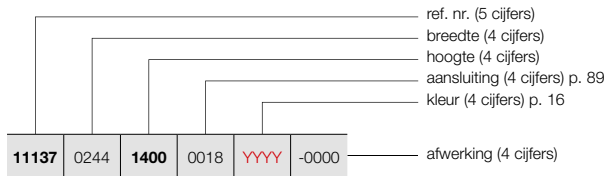

### CARRÉ KWARTROND (CR-A)



CR-A

### HOE VOORRAADRADIATOR CARRÉ KWARTROND BESTELLEN

Leveringstermijn 5 werkdagen  
(zonder transportduur)

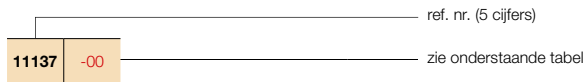

BESTELCODE MAATWERK CARRÉ KWARTROND	TECHNISCHE GEGEVENS									STANDAARDKLEUR		ANDERE KLEUREN					
	buizen	breedte (L mm)	hoogte (H mm)	75/65/20 (Watt)	55/45/20 (Watt)	n-exp.	gewicht (kg)	inhoud (l)	el. weerst. (Watt)	prijs RAL 9016	verkorte ref. nr. RAL 9016 voorraad	prijs kleur					
<b>REF. NR. CARRÉ KWARTROND CR-A : 11137</b>																	
<b>11137</b>	0244	<b>1400</b>	0018	<b>YYYY</b>	-0000	8	244	1400	610	316	1,29	11,30	5,50	-	<b>393</b>	-	<b>452</b>
		<b>1800</b>				8	244	1800	785	408	1,28	14,30	6,00	-	<b>467</b>	-	<b>537</b>
		<b>2000</b>				8	244	2000	862	448	1,28	16,00	7,15	-	<b>501</b>	-	<b>576</b>
		<b>2200</b>				8	244	2200	933	485	1,28	17,70	8,30	-	<b>535</b>	-	<b>615</b>
<b>11137</b>	0298	<b>1400</b>	0018	<b>YYYY</b>	-0000	10	298	1400	810	426	1,26	14,25	7,50	-	<b>491</b>	-	<b>565</b>
		<b>1800</b>				10	298	1800	963	503	1,27	17,75	9,50	-	<b>583</b>	<b>11137-06</b>	<b>670</b>
		<b>2000</b>				10	298	2000	1095	572	1,27	19,78	10,55	-	<b>627</b>	-	<b>721</b>
		<b>2200</b>				10	298	2200	1227	645	1,26	21,80	11,60	-	<b>669</b>	-	<b>769</b>

CE 12 conform EN442-1: radiatoren en convectoren

Voor de warmteafgiftes van andere regimes, kijkt u op p. 308 (correctiefactoren)  
Prijzen in euro (excl. BTW)

# CARRÉ VRIJSTAANDE OPSTELLING

IN OPTIE

ACCESSOIRES		KLEUR	ART. NR.	€
VRIJSTAANDE OPSTELLING		<b>CPVN2-ZB</b>		
		RAL 9016	*	<b>62</b>
		KLEUR	*	<b>71</b>
<ul style="list-style-type: none"> <li>vrijstaande radiatoren in de kleur RAL 9016 en Pergamon: 1 aparte zijbevestiging, 2 voeten (H=150 mm) en 2 rosetten in de betreffende kleur.</li> <li>vrijstaande radiatoren in de overige kleuren: 1 aparte zijbevestiging, 2 voeten (H=150 mm) in de kleur van de radiator en 2 verchroomde rosetten.</li> <li>Gelieve bij bestelling <b>code -0001</b> aan te geven bij "Afwerking".</li> </ul>				

# CARRÉ ACCESSOIRES

IN OPTIE

ACCESSOIRES	BREEDTE RADIATOR	KLEUR	ART. NR.	€
KNOP VIERKANT	<b>CPVN-PLUS / CPVN2-ZB / CPHN1-RO / CPHN2-RO / CB / CR-O / CR-A</b>			
		CHROOM	118350000000099	<b>64</b>
<ul style="list-style-type: none"> <li>h = 24 mm; b = 24 mm; d = 65 mm</li> </ul>				
HANDDOEKBEUGEL RECHT	<b>CPVN-PLUS / CPVN2-ZB / CPHN1-RO / CPHN2-RO / CB</b>			
		CHROOM	118320700000099	<b>166</b>
<ul style="list-style-type: none"> <li>h = 24 mm; b = 720 mm (zelf in te korten); d = 66 mm; a = 48 mm</li> </ul>				
HANDDOEKBEUGEL ROND	<b>CR-O</b>			
	350 mm	ALUMINIUM	118321000000000	<b>201</b>
	430 mm	ALUMINIUM	118321100000000	<b>201</b>
<ul style="list-style-type: none"> <li>Handdoekbeugel rond CR-O 350 mm; h = 40 mm; b = 518 mm; d = 65 mm; a = 50 mm</li> <li>Handdoekbeugel rond CR-O 430 mm; h = 40 mm; b = 598 mm; d = 65 mm; a = 50 mm</li> </ul>				
HANDDOEKBEUGEL ROND	<b>CR-A</b>			
	244 mm	ALUMINIUM	118320800000000	<b>201</b>
	298 mm	ALUMINIUM	118320900000000	<b>201</b>
<ul style="list-style-type: none"> <li>Handdoekbeugel rond CR-A 244 mm; h = 40 mm; b = 335 mm; d = 65 mm; a = 50 mm</li> <li>Handdoekbeugel rond CR-A 298 mm; h = 40 mm; b = 386 mm; d = 65 mm; a = 50 mm</li> </ul>				

d = afstand voorkant accessoire tot voorkant radiator  
a = afstand accessoire tot radiator  
**uit voorraad leverbaar**

**CARRÉ PLUS VERTICAAL: CPVN-PLUS (VOORRAAD)**  
**CARRÉ VERTICAAL: CPVN2-ZB (VOORRAAD)**

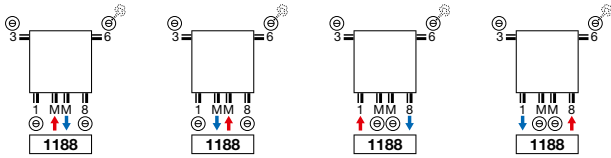

**CARRÉ PLUS VERTICAAL: CPVN-PLUS (NIET-VOORRAAD)**  
**CARRÉ VERTICAAL: CPVN2-ZB (NIET-VOORRAAD)**

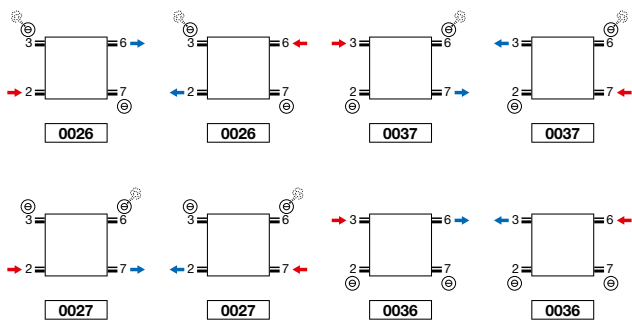
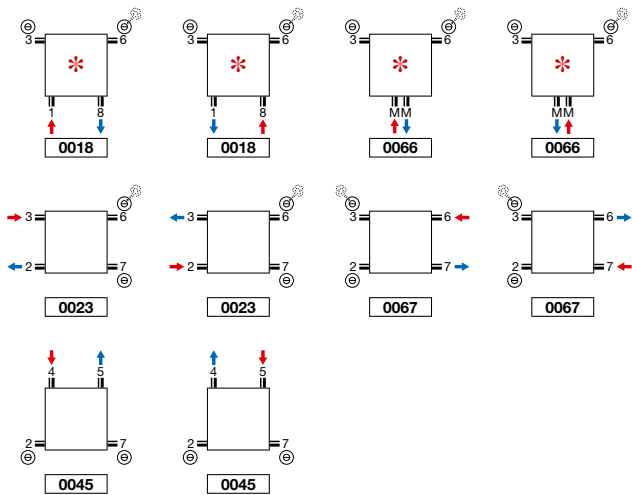

\* **Opmerking CPVN-PLUS/CPVN2-ZB 10 buizen: 2/3/6/7 altijd open.**

**CARRÉ HALFROND: CR-O**  
**CARRÉ KWARTROND: CR-A**

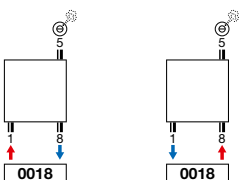

**CARRÉ KWARTROND: CR-A**



• **De aansluitleidingen moeten loodrecht uit de wand komen!**

**CARRÉ HORIZONTAAL: CPHN1-RO / CPHN2-RO**

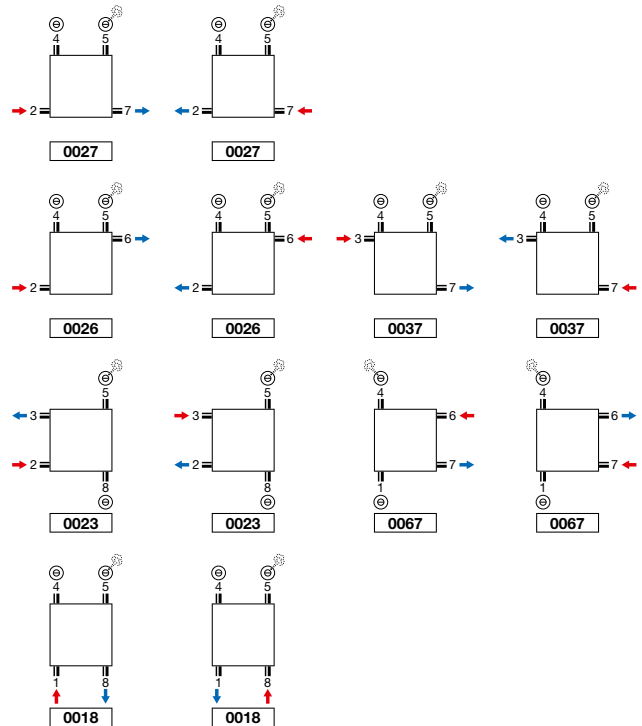

**CARRÉ BAD: CB (VOORRAAD) / CB (NIET-VOORRAAD)**

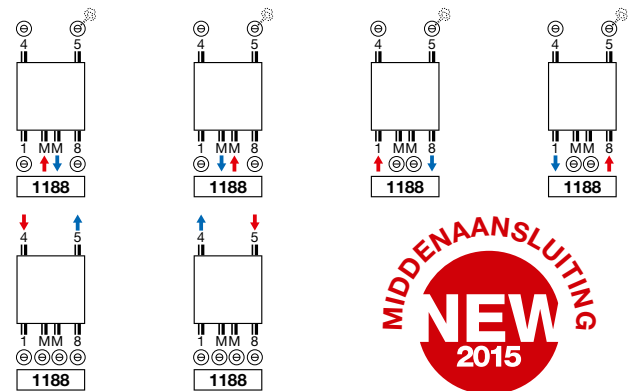

**CARRÉ BAD: CB (NIET-VOORRAAD)**

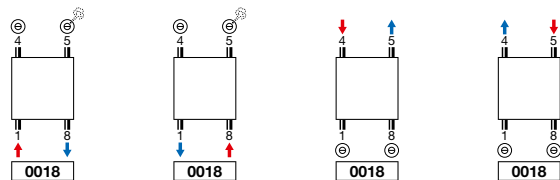

**Opmerking:** het aansluiten van de radiator kan enkel volgens de getoonde aansluiticonen. Voor elke andere aansluitwijze nemen wij geen verantwoordelijkheid.



**CARRÉ PLUS VERTICAAL (CPVN-PLUS)**

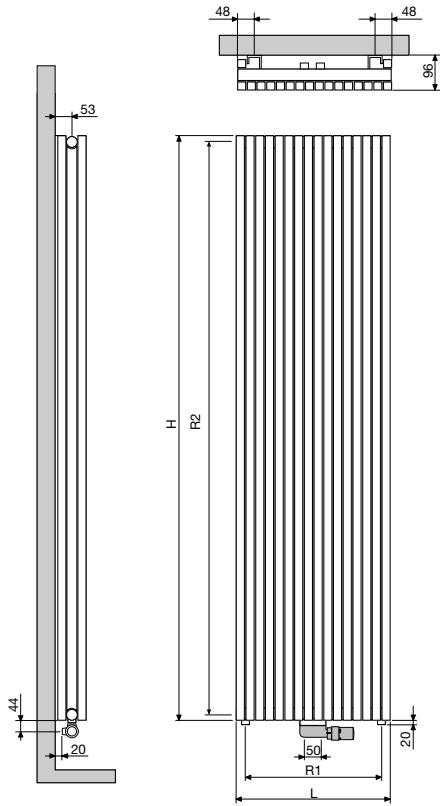

**CPVN-PLUS**

Aantal buizen	10	12	14	16	18	20	22	26	30
Breedte (L)	295	355	415	475	535	595	655	775	895
Hartafstand tussen de onderaansluitingen 18 (R1)	240	300	360	420	480	540	600	720	840
Hoogte (H)	1400	1600	1800	2000	2200				
Hartafstand tussen de zijaansluitingen 23/67 (R2)	1365	1565	1765	1965	2165				
Hartafstand tussen de ophangingen	L-200	H-290							

**CARRÉ VERTICAAL (CPVN2-ZB)**

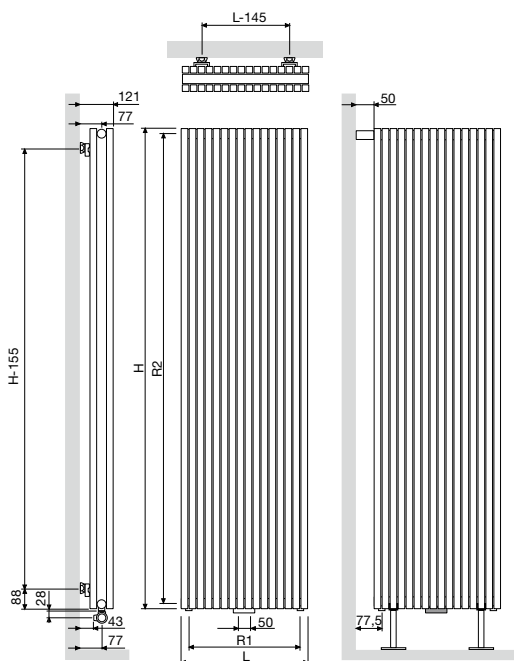

**CPVN2-ZB**

Aantal buizen	10	12	14	16	18	20	22	26	30
Breedte (L)	295	355	415	475	535	595	655	775	895
Hartafstand tussen de onderaansluitingen 18 (R1)	240	300	360	420	480	540	600	720	840
Hoogte (H)	1400	1600	1800	2000	2200	2400	2600	2800	3000
Hartafstand tussen de zijaansluitingen 23/67 (R2)	1365	1565	1765	1965	2165	2365	2565	2765	2965
Hartafstand tussen de ophangingen	L-145	H-155							

**CARRÉ HORIZONTAAL** (CPHN1-RO, CPHN2-RO)

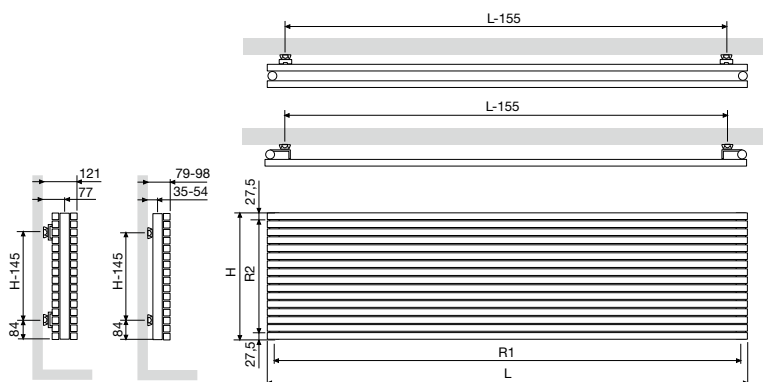

**CPHN1-RO / CPHN2-RO**

Breedte (L)	600	800	1000	1200	1400	1600	1800	2000	2200	2400	2600	2800	3000
Hartafstand tussen de onderaansluitingen 18 (R1)	565	765	965	1165	1365	1565	1765	1965	2165	2365	2565	2765	2965
Hoogte (H)	295	355	415	475	535	595	655	715	775	835			
Hartafstand tussen de zijansluitingen 23/67 (R2)	240	300	360	420	480	540	600	720	840				
Hartafstand tussen de ophangingen	L-155	H-145											

**CARRÉ BAD** (CB)

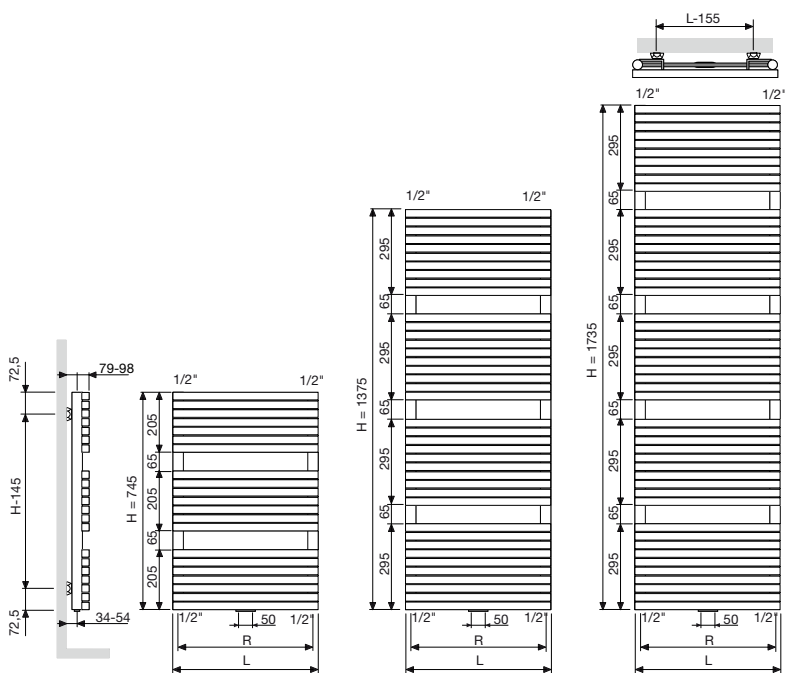

Breedte (L)	500	600
Hartafstand tussen de onderaansluitingen 18 (R)	465	565
Hartafstand tussen de ophangingen	L-155	H-145

CARRÉ HALFROND (CR-O)

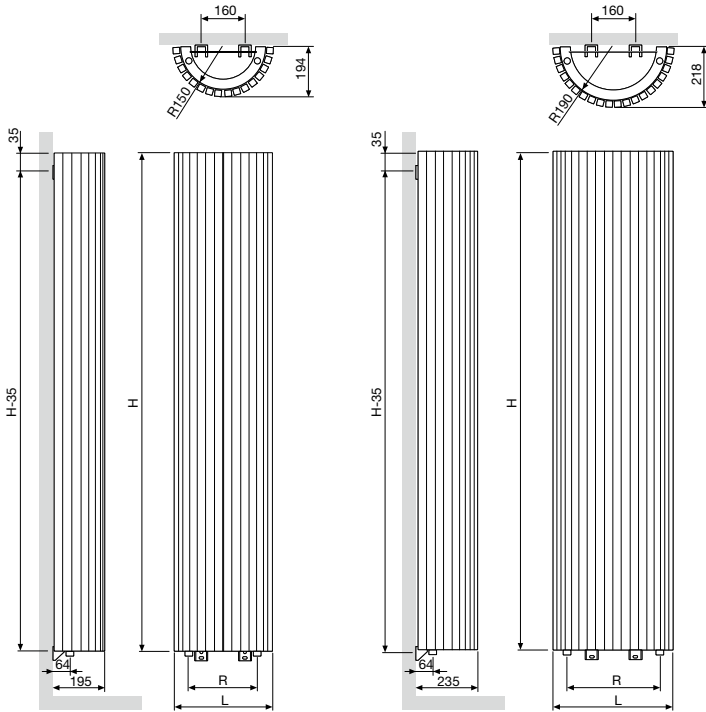

	CR-O	
Breedte (L)	350	430
Hartafstand tussen de onderaansluitingen 18 (R)	249	333
Hartafstand tussen de ophangingen	H-35	

CARRÉ KWARTTROND (CR-A)

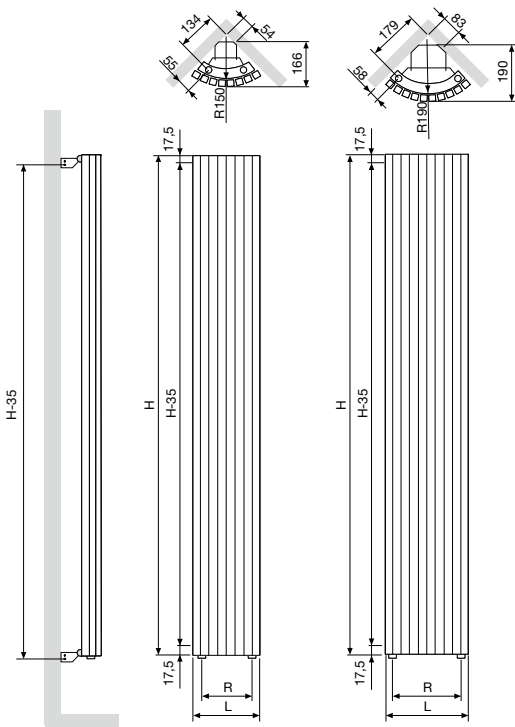

	CR-A	
Breedte (L)	244	298
Hartafstand tussen de onderaansluitingen 18 (R)	112	171
Hartafstand tussen de ophangingen	H-35	

#### TYPES

- Eén (ZV-1) of twee rijen buizen (ZV-2)

#### BUIZEN

- Verticaal, rechthoekig 45 x 20 mm

#### COLLECTOREN

- Horizontaal, achterliggend, rond Ø 35 mm

#### KLEUREN

- Standaardkleur wit RAL 9016
- Niet verkrijgbaar in kleur Gloss White
- Uitgebreide kleurenkaart zie p. 16

#### BEVESTIGINGEN

- Muurbevestigingen standaard
- ZV-2 ook verkrijgbaar als vrijstaande opstelling, zie p. 116

#### TECHNISCH

- Elektrisch lasergelast (onzichtbare lasnaden)
- KTL-grondlaag, poedercoating
- Standaardwerkdruk: 4 bar
- Maximale bedrijfstemperatuur: 110°C

#### ELEKTRISCH (zie hoofdstuk elektrische radiatoren)

- ✗ Zuiver elektrische radiator in de fabriek vorgevuld
- ✗ Gemengde radiator

#### TECHNISCHE TEKENINGEN

- Zie p. 119

#### AANSLUITING

- ✓ Eénpuntsaansluiting voor éénpijpssysteem (radiator speciaal te bestellen) (zie p. 301)
- ✓ Eénpuntsaansluiting voor tweepijpssysteem (radiator speciaal te bestellen) (zie p. 301)
- ✓ Tweepuntsaansluiting voor éénpijpssysteem (aansluiting via de middenaansluiting) (zie p. 300)
- ✓ Tweepuntsaansluiting voor tweepijpssysteem (standaard) (zie p. 300)
- ✗ Geïntegreerd ventiel

#### AANBEVOLEN AANSLUITING (1188)

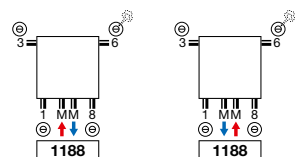

Andere aansluitmogelijkheden, zie p. 117

retour aanvoer



art. nr. 118210300000099

prijs € 155

Koppelingen, zie p. 313

#### AANBEVOLEN VOOR BADKAMER IN OPTIE



handdoekbeugel recht (chrom)

art. nr. 118322800000099

prijs € 166

Andere accessoires, zie p. 116

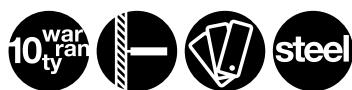

ZV-2



#### OVER ZANA VERTICAAL

##### Traditie en trends in perfecte harmonie

De Zana combineert een onklopbaar vermogen met een tijdloze lijnvoering. Een klassieker die blijft bekoren door zijn kracht, zijn klasse en zijn comfort. Het retrogevoel is nooit ver weg. Maar ook de moderniteit is volop aanwezig in dit unieke gamma designradiatoren voor elke woonomgeving, elke ruimte, elke toepassing.

# ZANA VERTICAAL (ZV-1)



ZV-1

## HOE ZANA VERTICAAL BESTELLEN

Leveringstermijn 15 - 30 werkdagen  
(zonder transportduur)

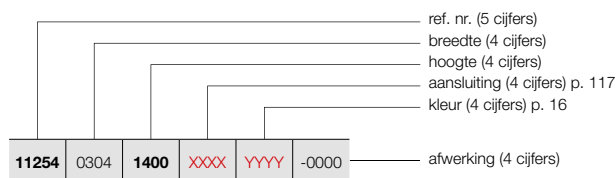

## HOE VOORRAADRADIATOR ZANA VERTICAAL BESTELLEN

Leveringstermijn 5 werkdagen  
(zonder transportduur)

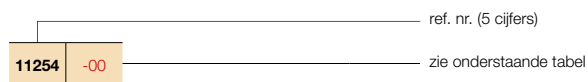

BESTELCODE MAATWERK ZANA VERTICAAL						TECHNISCHE GEGEVENS							STANDAARDKLEUR		ANDERE KLEUREN			
						buizen	breedte (L mm)	hoogte (H mm)	75/65/20 (Watt)	55/45/20 (Watt)	n-exp.	gewicht (kg)	inhoud (l)	el. weerst. (Watt)	prijs RAL 9016	verkorte ref. nr. RAL 9016 voorraad	prijs kleur	verkorte ref. nr. M301 voorraad
<b>REF. NR. ZANA VERTICAAL ZV-1 : 11254</b>																		
11254	0304	1400	XXXX	YYYY	-0000	8	304	1400	680	359	1,27	18,16	8,24	-	344	-	396	-
		1600				8	304	1600	769	406	1,27	20,72	9,44	-	374	-	430	-
		1800				8	304	1800	859	454	1,28	23,20	10,64	-	404	-	465	-
		2000				8	304	2000	950	502	1,28	25,68	11,68	-	434	-	499	-
		2200				8	304	2200	1042	550	1,28	28,08	12,72	-	464	-	534	-
		2400				8	304	2400	1136	600	1,29	30,56	13,76	-	494	-	568	-
		2600				8	304	2600	1231	650	1,29	33,04	14,80	-	524	-	603	-
		2800				8	304	2800	1327	701	1,29	35,44	15,84	-	554	-	637	-
		3000				8	304	3000	1426	753	1,29	37,92	16,88	-	585	-	673	-
11254	0384	1400	XXXX	YYYY	-0000	10	384	1400	850	449	1,27	22,70	10,30	-	413	-	475	-
		1600				10	384	1600	962	508	1,27	25,90	11,80	-	451	-	519	-
		1800				10	384	1800	1074	567	1,28	29,00	13,30	-	488	11254-03	561	11254-04
		2000				10	384	2000	1188	627	1,28	32,10	14,60	-	526	-	605	-
		2200				10	384	2200	1303	688	1,28	35,10	15,90	-	563	-	647	-
		2400				10	384	2400	1420	750	1,29	38,20	17,20	-	601	-	691	-
		2600				10	384	2600	1539	813	1,29	41,30	18,50	-	639	-	735	-
		2800				10	384	2800	1659	876	1,29	44,30	19,80	-	676	-	777	-
		3000				10	384	3000	1782	941	1,29	47,40	21,10	-	714	-	821	-
11254	0464	1400	XXXX	YYYY	-0000	12	464	1400	1020	539	1,27	27,24	12,36	-	482	-	554	-
		1600				12	464	1600	1154	609	1,27	31,08	14,16	-	527	-	606	-
		1800				12	464	1800	1289	681	1,28	34,80	15,96	-	572	11254-12	658	11254-05
		2000				12	464	2000	1425	752	1,28	38,52	17,52	-	617	11254-01	710	-
		2200				12	464	2200	1563	825	1,28	42,12	19,08	-	663	-	762	-
		2400				12	464	2400	1704	900	1,29	45,84	20,64	-	708	-	814	-
		2600				12	464	2600	1846	975	1,29	49,56	22,20	-	753	-	866	-
		2800				12	464	2800	1991	1051	1,29	53,16	23,76	-	798	-	918	-
		3000				12	464	3000	2139	1130	1,29	56,88	25,32	-	843	-	969	-
11254	0544	1400	XXXX	YYYY	-0000	14	544	1400	1190	628	1,27	31,78	14,42	-	551	-	634	-
		1600				14	544	1600	1346	711	1,27	36,26	16,52	-	604	-	695	-
		1800				14	544	1800	1504	794	1,28	40,60	18,62	-	656	11254-06	754	11254-07
		2000				14	544	2000	1663	878	1,28	44,94	20,44	-	709	11254-08	815	-
		2200				14	544	2200	1824	963	1,28	49,14	22,26	-	762	-	876	-
		2400				14	544	2400	1988	1050	1,29	53,48	24,08	-	814	-	936	-
		2600				14	544	2600	2154	1137	1,29	57,82	25,90	-	867	-	997	-
		2800				14	544	2800	2323	1227	1,29	62,02	27,72	-	920	-	1058	-
		3000				14	544	3000	2495	1318	1,29	66,36	29,54	-	972	-	1118	-
11254	0624	1400	XXXX	YYYY	-0000	16	624	1400	1360	718	1,27	36,32	16,48	-	620	-	713	-
		1600				16	624	1600	1539	813	1,27	41,44	18,88	-	680	-	782	-
		1800				16	624	1800	1719	908	1,28	46,40	21,28	-	741	11254-09	852	11254-10
		2000				16	624	2000	1900	1003	1,28	51,36	23,36	-	801	11254-02	921	-
		2200				16	624	2200	2085	1101	1,28	56,16	25,44	-	861	-	990	-
		2400				16	624	2400	2272	1200	1,29	61,12	27,52	-	921	-	1059	-
		2600				16	624	2600	2462	1300	1,29	66,08	29,60	-	981	-	1128	-
		2800				16	624	2800	2655	1402	1,29	70,88	31,68	-	1041	-	1197	-
		3000				16	624	3000	2852	1506	1,29	75,84	33,76	-	1101	-	1266	-

CE 05 conform EN442-1: radiatoren en convectoren

Voor de warmteafgifte van andere regimes, kijkt u op p. 308 (correctiefactoren)  
Prijzen in euro (excl. BTW)

## HOE ZANA VERTICAAL BESTELLEN

Leveringstermijn 15 - 30 werkdagen  
(zonder transportduur)

11254	0304	1400	XXXX	YYYY	-0000		
						afwerking (4 cijfers)	
							ref. nr. (5 cijfers)
							breedte (4 cijfers)
							hoogte (4 cijfers)
							aansluiting (4 cijfers) p. 117
							kleur (4 cijfers) p. 16

## ZANA VERTICAAL (ZV-1)



ZV-1

## HOE VOORRAADRADIATOR ZANA VERTICAAL BESTELLEN

Leveringstermijn 5 werkdagen  
(zonder transportduur)

11254	-00		
			zie onderstaande tabel
			ref. nr. (5 cijfers)

BESTELCODE MAATWERK ZANA VERTICAAL	TECHNISCHE GEGEVENS								STANDAARDKLEUR		ANDERE KLEUREN							
	buizen	breedte (L mm)	hoogte (H mm)	75/65/20 (Watt)	55/45/20 (Watt)	n-exp.	gewicht (kg)	inhoud (l)	el. weerst. (Watt)	prijs RAL 9016	verkorte ref. nr. RAL 9016 voorraad	prijs kleur	verkorte ref. nr. M301 voorraad					
REF. NR. ZANA VERTICAAL ZV-1 : 11254																		
11254	0704	1400	XXXX	YYYY	-0000	18	704	1400	1531	808	1,27	40,86	18,54	-	689	-	792	-
		1600				18	704	1600	1731	914	1,27	46,62	21,24	-	757	-	871	-
		1800				18	704	1800	1933	1021	1,28	52,20	23,94	-	825	-	949	-
		2000				18	704	2000	2138	1129	1,28	57,78	26,28	-	892	11254-11	1026	-
		2200				18	704	2200	2345	1238	1,28	63,18	28,62	-	960	-	1104	-
		2400				18	704	2400	2555	1349	1,29	68,76	30,96	-	1028	-	1182	-
		2600				18	704	2600	2769	1462	1,29	74,34	33,30	-	1095	-	1259	-
		2800				18	704	2800	2987	1577	1,29	79,74	35,64	-	1163	-	1337	-
		3000				18	704	3000	3208	1694	1,29	85,32	37,98	-	1231	-	1416	-
11254	0784	1400	XXXX	YYYY	-0000	20	784	1400	1701	898	1,27	45,40	20,60	-	758	-	872	-
		1600				20	784	1600	1923	1015	1,27	51,80	23,60	-	834	-	959	-
		1800				20	784	1800	2148	1134	1,28	58,00	26,60	-	909	-	1045	-
		2000				20	784	2000	2375	1254	1,28	64,20	29,20	-	984	-	1132	-
		2200				20	784	2200	2606	1376	1,28	70,20	31,80	-	1059	-	1218	-
		2400				20	784	2400	2839	1499	1,29	76,40	34,40	-	1134	-	1304	-
		2600				20	784	2600	3077	1625	1,29	82,60	37,00	-	1209	-	1390	-
		2800				20	784	2800	3319	1753	1,29	88,60	39,60	-	1285	-	1478	-
		3000				20	784	3000	3564	1882	1,29	94,80	42,20	-	1360	-	1564	-
11254	0864	1400	XXXX	YYYY	-0000	22	864	1400	1871	988	1,27	49,94	22,66	-	828	-	952	-
		1600				22	864	1600	2116	1117	1,27	56,98	25,96	-	910	-	1047	-
		1800				22	864	1800	2363	1248	1,28	63,80	29,26	-	993	-	1142	-
		2000				22	864	2000	2613	1380	1,28	70,62	32,12	-	1076	-	1237	-
		2200				22	864	2200	2866	1513	1,28	77,22	34,98	-	1158	-	1332	-
		2400				22	864	2400	3123	1649	1,29	84,04	37,84	-	1241	-	1427	-
		2600				22	864	2600	3385	1788	1,29	90,86	40,70	-	1324	-	1523	-
		2800				22	864	2800	3650	1927	1,29	97,46	43,56	-	1406	-	1617	-
		3000				22	864	3000	3921	2071	1,29	104,28	46,42	-	1489	-	1712	-
11254	0944	1400	XXXX	YYYY	-0000	24	944	1400	2041	1078	1,27	54,48	24,72	-	897	-	1032	-
		1600				24	944	1600	2308	1219	1,27	62,16	28,32	-	987	-	1135	-
		1800				24	944	1800	2578	1361	1,28	69,60	31,92	-	1077	-	1239	-
		2000				24	944	2000	2850	1505	1,28	77,04	35,04	-	1167	-	1342	-
		2200				24	944	2200	3127	1651	1,28	84,24	38,16	-	1257	-	1446	-
		2400				24	944	2400	3407	1799	1,29	91,68	41,28	-	1348	-	1550	-
		2600				24	944	2600	3692	1950	1,29	99,12	44,40	-	1438	-	1654	-
		2800				24	944	2800	3982	2103	1,29	106,32	47,52	-	1528	-	1757	-
		3000				24	944	3000	4277	2259	1,29	113,76	50,64	-	1618	-	1861	-
11254	1024	1400	XXXX	YYYY	-0000	26	1024	1400	2211	1168	1,27	59,02	26,78	-	966	-	1111	-
		1600				26	1024	1600	2500	1320	1,27	67,34	30,68	-	1063	-	1222	-
		1800				26	1024	1800	2793	1475	1,28	75,40	34,58	-	1161	-	1335	-
		2000				26	1024	2000	3088	1631	1,28	83,46	37,96	-	1259	-	1448	-
		2200				26	1024	2200	3388	1789	1,28	91,26	41,34	-	1357	-	1561	-
		2400				26	1024	2400	3691	1949	1,29	99,32	44,72	-	1454	-	1672	-
		2600				26	1024	2600	4000	2112	1,29	107,38	48,10	-	1552	-	1785	-
		2800				26	1024	2800	4314	2278	1,29	115,18	51,48	-	1650	-	1898	-
		3000				26	1024	3000	4634	2447	1,29	123,24	54,86	-	1747	-	2009	-

# ZANA VERTICAAL (ZV-2)



ZV-2

## HOE ZANA VERTICAAL BESTELLEN

Leveringstermijn 15 - 30 werkdagen  
(zonder transportduur)

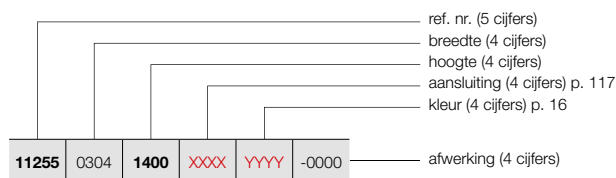

## VRIJSTAANDE OPSTELLING (ZV-2)

Zie p. 116 voor extra toebehoren.

## HOE VOORRAADRADIATOR ZANA VERTICAAL BESTELLEN

Leveringstermijn 5 werkdagen  
(zonder transportduur)

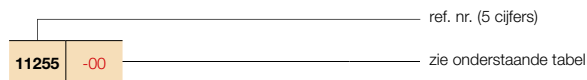

BESTELCODE MAATWERK ZANA VERTICAAL	TECHNISCHE GEGEVENS							STANDAARDKLEUR		ANDERE KLEUREN		
	buizen	breedte (L mm)	hoogte (H mm)	75/65/20 (Watt)	55/45/20 (Watt)	n-exp.	gewicht (kg)	inhoud (l)	el. weerst. (Watt)	prijs RAL 9016	verkorte ref. nr. RAL 9016 voorraad	prijs kleur
<b>REF. NR. ZANA VERTICAAL ZV-2 : 11255</b>												
11255 0304 1400 XXXX YYYY -0000	8	304	1400	1105	584	1,30	35,20	16,16	-	585	-	673
	8	304	1600	1242	656	1,30	40,16	18,40	-	636	-	731
	8	304	1800	1379	728	1,30	45,12	20,64	-	687	-	790
	8	304	2000	1515	800	1,30	50,00	23,28	-	738	-	849
	8	304	2200	1651	872	1,30	54,80	25,92	-	789	-	907
	8	304	2400	1788	944	1,30	59,68	28,56	-	840	-	966
	8	304	2600	1925	1017	1,30	64,48	31,12	-	891	-	1025
	8	304	2800	2062	1089	1,30	69,36	33,76	-	942	-	1083
	8	304	3000	2200	1162	1,30	74,16	36,40	-	995	-	1144
11255 0384 1400 XXXX YYYY -0000	10	384	1400	1381	729	1,30	44,00	20,20	-	702	-	807
	10	384	1600	1553	820	1,30	50,20	23,00	-	767	-	882
	10	384	1800	1724	910	1,30	56,40	25,80	-	830	-	955
	10	384	2000	1894	1000	1,30	62,50	29,10	-	894	-	1028
	10	384	2200	2064	1090	1,30	68,50	32,40	-	957	-	1101
	10	384	2400	2235	1180	1,30	74,60	35,70	-	1022	-	1175
	10	384	2600	2406	1271	1,30	80,60	38,90	-	1086	-	1249
	10	384	2800	2577	1361	1,30	86,70	42,20	-	1149	-	1321
	10	384	3000	2750	1452	1,30	92,70	45,50	-	1214	-	1396
11255 0464 1400 XXXX YYYY -0000	12	464	1400	1657	875	1,30	52,80	24,24	-	819	-	942
	12	464	1600	1863	984	1,30	60,24	27,60	-	896	-	1030
	12	464	1800	2068	1092	1,30	67,68	30,96	-	972	-	1118
	12	464	2000	2273	1200	1,30	75,00	34,92	-	1049	-	1206
	12	464	2200	2477	1308	1,30	82,20	38,88	-	1127	-	1296
	12	464	2400	2682	1416	1,30	89,52	42,84	-	1204	-	1385
	12	464	2600	2887	1525	1,30	96,72	46,68	-	1280	-	1472
	12	464	2800	3093	1633	1,30	104,04	50,64	-	1357	-	1561
	12	464	3000	3300	1743	1,30	111,24	54,60	-	1433	-	1648
11255 0544 1400 XXXX YYYY -0000	14	544	1400	1933	1021	1,30	61,60	28,28	-	937	-	1078
	14	544	1600	2174	1148	1,30	70,28	32,20	-	1027	-	1181
	14	544	1800	2413	1274	1,30	78,96	36,12	-	1115	-	1282
	14	544	2000	2651	1400	1,30	87,50	40,74	-	1205	11255-02	1386
	14	544	2200	2890	1526	1,30	95,90	45,36	-	1295	-	1489
	14	544	2400	3129	1652	1,30	104,44	49,98	-	1384	-	1592
	14	544	2600	3368	1779	1,30	112,84	54,46	-	1474	-	1695
	14	544	2800	3608	1905	1,30	121,38	59,08	-	1564	-	1799
	14	544	3000	3849	2033	1,30	129,78	63,70	-	1652	-	1900
11255 0624 1400 XXXX YYYY -0000	16	624	1400	2209	1167	1,30	70,40	32,32	-	1054	-	1212
	16	624	1600	2484	1312	1,30	80,32	36,80	-	1156	-	1329
	16	624	1800	2758	1456	1,30	90,24	41,28	-	1260	-	1449
	16	624	2000	3030	1600	1,30	100,00	46,56	-	1362	-	1566
	16	624	2200	3303	1744	1,30	109,60	51,84	-	1464	-	1684
	16	624	2400	3576	1888	1,30	119,36	57,12	-	1566	-	1801
	16	624	2600	3849	2033	1,30	128,96	62,24	-	1668	-	1918
	16	624	2800	4124	2178	1,30	138,72	67,52	-	1770	-	2036
	16	624	3000	4399	2323	1,30	148,32	72,80	-	1872	-	2153

CE 05 conform EN442-1: radiatoren en convectoren

Voor de warmteafgiftes van andere regimes, kijkt u op p. 308 (correctiefactoren)  
Prijzen in euro (excl. BTW)

## HOE ZANA VERTICAAL BESTELLEN

Leveringstermijn 15 - 30 werkdagen  
(zonder transportduur)

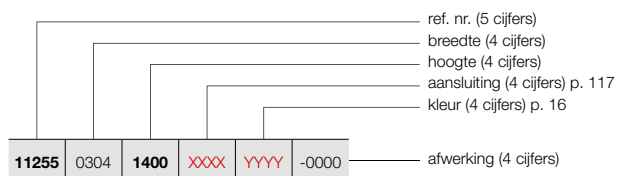

## VRIJSTAANDE OPSTELLING (ZV-2)

Zie p. 116 voor extra toebehoren.

## HOE VOORRAADRADIATOR ZANA VERTICAAL BESTELLEN

Leveringstermijn 5 werkdagen  
(zonder transportduur)

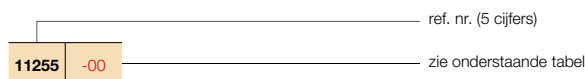

## ZANA VERTICAAL (ZV-2)



ZV-2

BESTELCODE MAATWERK ZANA VERTICAAL	TECHNISCHE GEGEVENS									STANDAARDKLEUR		ANDERE KLEUREN					
	buizen	breedte (L mm)	hoogte (H mm)	75/65/20 (Watt)	55/45/20 (Watt)	n-exp.	gewicht (kg)	inhoud (l)	el. weerst. (Watt)	prijs RAL 9016	verkorte ref. nr. RAL 9016 voorraad	prijs kleur					
<b>REF. NR. ZANA VERTICAAL ZV-2 : 11255</b>																	
11255	0704	1400	XXXX	YYYY	-0000	18	704	1400	2486	1313	1,30	79,20	36,36	-	1171	-	1347
		1600				18	704	1600	2795	1476	1,30	90,36	41,40	-	1287	-	1480
		1800				18	704	1800	3102	1638	1,30	101,52	46,44	-	1403	-	1613
		2000				18	704	2000	3409	1800	1,30	112,50	52,38	-	1516	11255-01	1743
		2200				18	704	2200	3716	1962	1,30	123,30	58,32	-	1632	-	1877
		2400				18	704	2400	4023	2124	1,30	134,28	64,26	-	1748	-	2010
		2600				18	704	2600	4330	2287	1,30	145,08	70,02	-	1862	-	2141
		2800				18	704	2800	4639	2450	1,30	156,06	75,96	-	1977	-	2274
11255	0784	1400	XXXX	YYYY	-0000	20	784	1400	2762	1459	1,30	88,00	40,40	-	1289	-	1482
		1600				20	784	1600	3105	1640	1,30	100,40	46,00	-	1418	-	1631
		1800				20	784	1800	3447	1820	1,30	112,80	51,60	-	1545	-	1777
		2000				20	784	2000	3788	2000	1,30	125,00	58,20	-	1673	-	1924
		2200				20	784	2200	4129	2180	1,30	137,00	64,80	-	1800	-	2070
		2400				20	784	2400	4470	2360	1,30	149,20	71,40	-	1928	-	2217
		2600				20	784	2600	4812	2541	1,30	161,20	77,80	-	2055	-	2363
11255	0864	1400	XXXX	YYYY	-0000	22	864	1400	3038	1604	1,30	96,80	44,44	-	1408	-	1619
		1600				22	864	1600	3416	1804	1,30	110,44	50,60	-	1547	-	1779
		1800				22	864	1800	3792	2002	1,30	124,08	56,76	-	1688	-	1941
		2000				22	864	2000	4167	2200	1,30	137,50	64,02	-	1829	-	2103
		2200				22	864	2200	4541	2398	1,30	150,70	71,28	-	1969	-	2264
11255	0944	1400	XXXX	YYYY	-0000	24	944	1400	3314	1750	1,30	105,60	48,48	-	1525	-	1754
		1600				24	944	1600	3726	1968	1,30	120,48	55,20	-	1678	-	1930
		1800				24	944	1800	4136	2184	1,30	135,36	61,92	-	1831	-	2106
		2000				24	944	2000	4545	2400	1,30	150,00	69,84	-	1984	-	2282
11255	1024	1400	XXXX	YYYY	-0000	26	1024	1400	3590	1896	1,30	114,40	52,52	-	1642	-	1888
		1600				26	1024	1600	4037	2132	1,30	130,52	59,80	-	1807	-	2078
		1800				26	1024	1800	4481	2366	1,30	146,64	67,08	-	1974	-	2270

CE 05 conform EN442-1: radiatoren en convectoren

Voor de warmteafgiftes van andere regimes, kijkt u op p. 308 (correctiefactoren)  
Prijzen in euro (excl. BTW)



## ZANA HORIZONTAAL (ZH-1, ZH-2)



### TYPES

- Eén (ZH-1) of twee rijen buizen (ZH-2)

### BUIZEN

- Verticaal, rechthoekig 45 x 20 mm
- Opgelet: horizontale vormgeving, maar steeds met verticale buizen!

### COLLECTOREN

- Horizontaal, achterliggend, rond Ø 35 mm

### KLEUREN

- Standaardkleur wit RAL 9016
- Niet verkrijgbaar in kleur Gloss White
- Uitgebreide kleurenkaart zie p. 16

### SPECIAAL

- ZH-1 ook verkrijgbaar als toiletradiator (384 x 500 mm)

### BEVESTIGINGEN

- Muurbevestigingen standaard

### TECHNISCH

- Elektrisch lasergelast (onzichtbare lasnaden)
- KTL-grondlaag, poedercoating
- Standaardwerkdruk: 4 bar
- Maximale bedrijfstemperatuur: 110°C

### ELEKTRISCH (zie hoofdstuk elektrische radiatoren)

- ✗ Zuiver elektrische radiator in de fabriek voorgevuld
- ✗ Gemengde radiator

### TECHNISCHE TEKENINGEN

- Zie p. 119

### AANSLUITING

- ✓ Eénpuntsaansluiting voor éénpijpssysteem (radiator speciaal te bestellen) (zie p. 301)
- ✓ Eénpuntsaansluiting voor tweepijpssysteem (radiator speciaal te bestellen) (zie p. 301)
- ✗ Tweepuntsaansluiting voor éénpijpssysteem
- ✓ Tweepuntsaansluiting voor tweepijpssysteem (standaard) (zie p. 300)
- ✗ Geïntegreerd ventiel

## OVER ZANA HORIZONTAAL

### Mooi tot in lengte van dagen

Ook in de horizontale uitvoering is de Zana designradiator een toonbeeld van klasse, kracht en comfort. De verticale buizen en de horizontale collectoren vormen samen een mooi gestructureerd geometrisch geheel en dragen bij tot de specifieke Zana retro-look. De Zana Horizontaal is verkrijgbaar met 1 of 2 rijen buizen en in een aparte toiletversie.

### AANBEVOLEN AANSLUITING (0018)

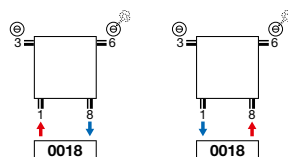

### Andere aansluitmogelijkheden, zie p. 117



art. nr. 118210100000099

**prijs € 155**

Koppelingen, zie p. 313

### AANBEVOLEN VOOR BADKAMER IN OPTIE



handdoekbeugel recht (chrom) art. nr. 118322800000099

**prijs € 166**

Andere accessoires, zie p. 116



## HOE ZANA HORIZONTAAL BESTELLEN

Leveringstermijn 15 - 30 werkdagen  
(zonder transportduur)

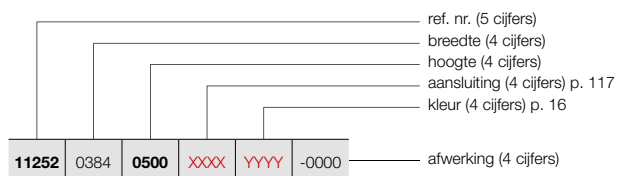

## ZANA HORIZONTAAL (ZH-1)



ZH-1

BESTELCODE MAATWERK ZANA HORIZONTAAL	TECHNISCHE GEGEVENS									STANDAARDKLEUR	ANDERE KLEUREN					
	buizen	breedte (L mm)	hoogte (H mm)	75/65/20 (Watt)	55/45/20 (Watt)	n-exp.	gewicht (kg)	inhoud (l)	el. weerst. (Watt)	prijs RAL 9016	prijs kleur					
REF. NR. ZANA HORIZONTAAL ZH-1 : 11252																
11252	0384	0500	XXXX	YYYY	-0000	10	384	500	347	183	1,25	9,00	4,10	-	244	281
11252	0704	0500	XXXX	YYYY	-0000	18	704	500	624	330	1,25	16,20	7,38	-	385	443
		18				704	600	728	384	1,25	18,90	8,46	-	419	482	
		18				704	700	831	439	1,25	21,60	9,72	-	453	521	
11252	0784	0500	XXXX	YYYY	-0000	20	784	500	694	366	1,25	18,00	8,20	-	420	483
		20				784	600	809	427	1,25	21,00	9,40	-	458	527	
		20				784	700	923	487	1,25	24,00	10,80	-	495	569	
11252	0864	0500	XXXX	YYYY	-0000	22	864	500	763	403	1,25	19,80	9,02	-	455	523
		22				864	600	890	470	1,25	23,10	10,34	-	497	572	
		22				864	700	1015	536	1,25	26,40	11,88	-	538	619	
11252	0944	0500	XXXX	YYYY	-0000	24	944	500	832	439	1,25	21,60	9,84	-	491	565
		24				944	600	971	513	1,25	25,20	11,28	-	536	616	
		24				944	700	1107	585	1,25	28,80	12,96	-	581	668	
11252	1024	0500	XXXX	YYYY	-0000	26	1024	500	902	476	1,25	23,40	10,66	-	526	605
		26				1024	600	1052	556	1,25	27,30	12,22	-	575	661	
		26				1024	700	1200	634	1,25	31,20	14,04	-	624	718	
11252	1104	0500	XXXX	YYYY	-0000	28	1104	500	971	513	1,25	25,20	11,48	-	561	645
		28				1104	600	1133	598	1,25	29,40	13,16	-	614	706	
		28				1104	700	1292	682	1,25	33,60	15,12	-	666	766	
11252	1184	0500	XXXX	YYYY	-0000	30	1184	500	1040	549	1,25	27,00	12,30	-	596	685
		30				1184	600	1214	641	1,25	31,50	14,10	-	653	751	
		30				1184	700	1384	731	1,25	36,00	16,20	-	709	815	
11252	1264	0500	XXXX	YYYY	-0000	32	1264	500	1110	586	1,25	28,80	13,12	-	632	727
		32				1264	600	1295	684	1,25	33,60	15,04	-	692	796	
		32				1264	700	1476	779	1,25	38,40	17,28	-	752	865	
11252	1424	0500	XXXX	YYYY	-0000	36	1424	500	1248	659	1,25	32,40	14,76	-	702	807
		36				1424	600	1457	769	1,25	37,80	16,92	-	770	886	
		36				1424	700	1661	877	1,25	43,20	19,44	-	838	964	
11252	1584	0500	XXXX	YYYY	-0000	40	1584	500	1387	732	1,25	36,00	16,40	-	773	889
		40				1584	600	1618	854	1,25	42,00	18,80	-	848	975	
		40				1584	700	1846	975	1,25	48,00	21,60	-	923	1061	
11252	1744	0500	XXXX	YYYY	-0000	44	1744	500	1526	806	1,25	39,60	18,04	-	843	969
		44				1744	600	1780	940	1,25	46,20	20,68	-	926	1065	
		44				1744	700	2030	1072	1,25	52,80	23,76	-	1009	1160	
11252	1904	0500	XXXX	YYYY	-0000	48	1904	500	1665	879	1,25	43,20	19,68	-	914	1051
		48				1904	600	1942	1026	1,25	50,40	22,56	-	1004	1155	
		48				1904	700	2215	1170	1,25	57,60	25,92	-	1094	1258	

CE 05 conform EN442-1: radiatoren en convectoren

Voor de warmteafgiftes van andere regimes, kijkt u op p. 308 (correctiefactoren)  
Prijzen in euro (excl. BTW)

# ZANA HORIZONTAAL (ZH-1)

## HOE ZANA HORIZONTAAL BESTELLEN

Leveringstermijn 15 - 30 werkdagen  
(zonder transportduur)



ZH-1

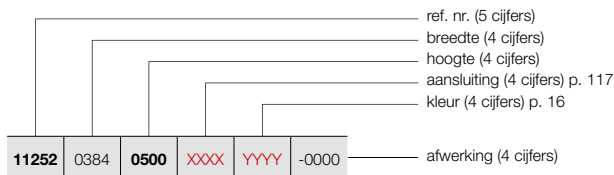

BESTELCODE MAATWERK ZANA HORIZONTAAL							TECHNISCHE GEGEVENS						STANDAARDKLEUR	ANDERE KLEUREN		
11252	2064	0500	XXXX	YYYY	-0000	buizen	breedte (L mm)	hoogte (H mm)	75/65/20 (Watt)	55/45/20 (Watt)	n-exp.	gewicht (kg)	inhoud (l)	el. weerst. (Watt)	prijs RAL 9016	prijs kleur
<b>REF. NR. ZANA HORIZONTAAL ZH-1 : 11252</b>																
11252	2064	0500	XXXX	YYYY	-0000	52	2064	500	1803	952	1,25	46,80	21,32	-	984	1132
		0600				52	2064	600	2104	1111	1,25	54,60	24,44	-	1082	1244
		0700				52	2064	700	2399	1267	1,25	62,40	28,08	-	1180	1357
11252	2224	0500	XXXX	YYYY	-0000	56	2224	500	1942	1026	1,25	50,40	22,96	-	1055	1213
		0600				56	2224	600	2266	1197	1,25	58,80	26,32	-	1160	1334
		0700				56	2224	700	2584	1365	1,25	67,20	30,24	-	1265	1455
11252	2384	0500	XXXX	YYYY	-0000	60	2384	500	2081	1099	1,25	54,00	24,60	-	1125	1294
		0600				60	2384	600	2428	1282	1,25	63,00	28,20	-	1238	1424
		0700				60	2384	700	2768	1462	1,25	72,00	32,40	-	1351	1554
11252	2544	0500	XXXX	YYYY	-0000	64	2544	500	2220	1172	1,25	57,60	26,24	-	1196	1375
		0600				64	2544	600	2589	1367	1,25	67,20	30,08	-	1316	1513
		0700				64	2544	700	2953	1559	1,25	76,80	34,56	-	1436	1651
11252	2704	0500	XXXX	YYYY	-0000	68	2704	500	2358	1245	1,25	61,20	27,88	-	1266	1456
		0600				68	2704	600	2751	1453	1,25	71,40	31,96	-	1394	1603
		0700				68	2704	700	3138	1657	1,25	81,60	36,72	-	1522	1750
11252	2864	0500	XXXX	YYYY	-0000	72	2864	500	2497	1319	1,25	64,80	29,52	-	1337	1538
		0600				72	2864	600	2913	1538	1,25	75,60	33,84	-	1472	1693
		0700				72	2864	700	3322	1754	1,25	86,40	38,88	-	1607	1848

€05 conform EN442-1: radiatoren en convectoren

Voor de warmteafgifte van andere regimes, kijkt u op p. 308 (correctiefactoren)  
Prijzen in euro (excl. BTW)

## HOE ZANA HORIZONTAAL BESTELLEN

Leveringstermijn 15 - 30 werkdagen  
(zonder transportduur)

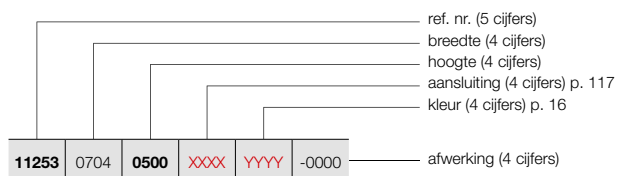

## ZANA HORIZONTAAL (ZH-2)



ZH-2

BESTELCODE MAATWERK ZANA HORIZONTAAL	TECHNISCHE GEGEVENS								STANDAARDKLEUR	ANDERE KLEUREN						
	buizen	breedte (L mm)	hoogte (H mm)	75/65/20 (Watt)	55/45/20 (Watt)	n-exp.	gewicht (kg)	inhoud (l)	el. weerst. (Watt)	prijs RAL 9016	prijs kleur					
<b>REF. NR. ZANA HORIZONTAAL ZH-2 : 11253</b>																
11253	0704	0500	XXXX	YYYY	-0000	18	704	500	1035	547	1,28	30,42	13,50	-	655	753
		0600				18	704	600	1205	636	1,28	35,64	16,02	-	712	819
		0700				18	704	700	1372	725	1,28	41,04	18,54	-	770	886
11253	0784	0500	XXXX	YYYY	-0000	20	784	500	1150	607	1,28	33,80	15,00	-	714	821
		0600				20	784	600	1339	707	1,28	39,60	17,80	-	779	896
		0700				20	784	700	1525	805	1,28	45,60	20,60	-	842	968
11253	0864	0500	XXXX	YYYY	-0000	22	864	500	1265	668	1,28	37,18	16,50	-	774	890
		0600				22	864	600	1473	778	1,28	43,56	19,58	-	845	972
		0700				22	864	700	1677	886	1,28	50,16	22,66	-	915	1052
11253	0944	0500	XXXX	YYYY	-0000	24	944	500	1380	729	1,28	40,56	18,00	-	835	960
		0600				24	944	600	1607	849	1,28	47,52	21,36	-	911	1048
		0700				24	944	700	1830	966	1,28	54,72	24,72	-	988	1136
11253	1024	0500	XXXX	YYYY	-0000	26	1024	500	1494	789	1,28	43,94	19,50	-	894	1028
		0600				26	1024	600	1741	919	1,28	51,48	23,14	-	978	1125
		0700				26	1024	700	1982	1047	1,28	59,28	26,78	-	1061	1220
11253	1104	0500	XXXX	YYYY	-0000	28	1104	500	1609	850	1,28	47,32	21,00	-	954	1097
		0600				28	1104	600	1875	990	1,28	55,44	24,92	-	1044	1201
		0700				28	1104	700	2135	1127	1,28	63,84	28,84	-	1132	1302
11253	1184	0500	XXXX	YYYY	-0000	30	1184	500	1724	910	1,28	50,70	22,50	-	1013	1165
		0600				30	1184	600	2009	1061	1,28	59,40	26,70	-	1110	1277
		0700				30	1184	700	2287	1208	1,28	68,40	30,90	-	1205	1386
11253	1264	0500	XXXX	YYYY	-0000	32	1264	500	1839	971	1,28	54,08	24,00	-	1074	1235
		0600				32	1264	600	2143	1132	1,28	63,36	28,48	-	1176	1352
		0700				32	1264	700	2440	1288	1,28	72,96	32,96	-	1278	1470
11253	1424	0500	XXXX	YYYY	-0000	36	1424	500	2069	1093	1,28	60,84	27,00	-	1193	1372
		0600				36	1424	600	2411	1273	1,28	71,28	32,04	-	1309	1505
		0700				36	1424	700	2745	1450	1,28	82,08	37,08	-	1425	1639
11253	1584	0500	XXXX	YYYY	-0000	40	1584	500	2299	1214	1,28	67,60	30,00	-	1314	1511
		0600				40	1584	600	2678	1414	1,28	79,20	35,60	-	1442	1658
		0700				40	1584	700	3050	1611	1,28	91,20	41,20	-	1569	1804
11253	1744	0500	XXXX	YYYY	-0000	44	1744	500	2529	1335	1,28	74,36	33,00	-	1433	1648
		0600				44	1744	600	2946	1556	1,28	87,12	39,16	-	1574	1810
		0700				44	1744	700	3355	1772	1,28	100,32	45,32	-	1715	1972
11253	1904	0500	XXXX	YYYY	-0000	48	1904	500	2759	1457	1,28	81,12	36,00	-	1554	1787
		0600				48	1904	600	3214	1697	1,28	95,04	42,72	-	1707	1963
		0700				48	1904	700	3660	1933	1,28	109,44	49,44	-	1860	2139

CE 05 conform EN442-1: radiatoren en convectoren

Voor de warmteafgiftes van andere regimes, kijkt u op p. 308 (correctiefactoren)  
Prijzen in euro (excl. BTW)

# ZANA HORIZONTAAL (ZH-2)

## HOE ZANA HORIZONTAAL BESTELLEN

Leveringstermijn 15 - 30 werkdagen  
(zonder transportduur)



ZH-2

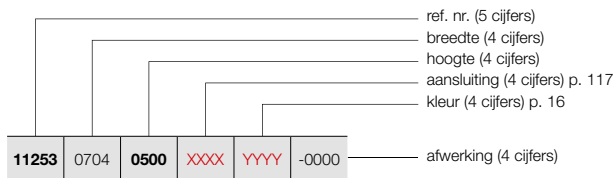

BESTELCODE MAATWERK ZANA HORIZONTAAL							TECHNISCHE GEGEVENS						STANDAARDKLEUR	ANDERE KLEUREN			
REF. NR.	ZANA HORIZONTAAL	ZH-2	11253				buizen	breedte (L mm)	hoogte (H mm)	75/65/20 (Watt)	55/45/20 (Watt)	n-exp.	gewicht (kg)	inhoud (l)	el. weerst. (Watt)	prijs RAL 9016	prijs kleur
<b>REF. NR. ZANA HORIZONTAAL ZH-2 : 11253</b>																	
<b>11253</b>	2064	<b>0500</b>	<b>XXXX</b>	<b>YYYY</b>	-0000		52	2064	500	2989	1578	1,28	87,88	39,00	-	<b>1673</b>	<b>1924</b>
		<b>0600</b>					52	2064	600	3482	1839	1,28	102,96	46,28	-	<b>1839</b>	<b>2115</b>
		<b>0700</b>					52	2064	700	3964	2093	1,28	118,56	53,56	-	<b>2006</b>	<b>2307</b>
<b>11253</b>	2224	<b>0500</b>	<b>XXXX</b>	<b>YYYY</b>	-0000		56	2224	500	3219	1700	1,28	94,64	42,00	-	<b>1794</b>	<b>2063</b>
		<b>0600</b>					56	2224	600	3750	1980	1,28	110,88	49,84	-	<b>1972</b>	<b>2268</b>
		<b>0700</b>					56	2224	700	4269	2254	1,28	127,68	57,68	-	<b>2151</b>	<b>2474</b>
<b>11253</b>	2384	<b>0500</b>	<b>XXXX</b>	<b>YYYY</b>	-0000		60	2384	500	3449	1821	1,28	101,40	45,00	-	<b>1913</b>	<b>2200</b>
		<b>0600</b>					60	2384	600	4018	2122	1,28	118,80	53,40	-	<b>2105</b>	<b>2421</b>
		<b>0700</b>					60	2384	700	4574	2415	1,28	136,80	61,80	-	<b>2297</b>	<b>2642</b>
<b>11253</b>	2544	<b>0500</b>	<b>XXXX</b>	<b>YYYY</b>	-0000		64	2544	500	3679	1943	1,28	108,16	48,00	-	<b>2033</b>	<b>2338</b>
		<b>0600</b>					64	2544	600	4285	2263	1,28	126,72	56,96	-	<b>2237</b>	<b>2573</b>
		<b>0700</b>					64	2544	700	4879	2576	1,28	145,92	65,92	-	<b>2441</b>	<b>2807</b>
<b>11253</b>	2704	<b>0500</b>	<b>XXXX</b>	<b>YYYY</b>	-0000		68	2704	500	3909	2064	1,28	114,92	51,00	-	<b>2152</b>	<b>2475</b>
		<b>0600</b>					68	2704	600	4553	2404	1,28	134,64	60,52	-	<b>2370</b>	<b>2726</b>
		<b>0700</b>					68	2704	700	5184	2737	1,28	155,04	70,04	-	<b>2587</b>	<b>2975</b>
<b>11253</b>	2864	<b>0500</b>	<b>XXXX</b>	<b>YYYY</b>	-0000		72	2864	500	4139	2186	1,28	121,68	54,00	-	<b>2273</b>	<b>2614</b>
		<b>0600</b>					72	2864	600	4821	2546	1,28	142,56	64,08	-	<b>2502</b>	<b>2877</b>

CE<sub>05</sub> conform EN442-1: radiatoren en convectoren

Voor de warmteafgiftes van andere regimes, kijkt u op p. 308 (correctiefactoren)  
Prijsen in euro (excl. BTW)

**BUIZEN**

- Verticaal, rechthoekig 45 x 20 mm

**COLLECTOREN**

- Horizontaal, achterliggend, rond Ø 35 mm

**KLEUREN**

- Standaardkleur wit RAL 9016
- Niet verkrijgbaar in kleur Gloss White
- Uitgebreide kleurenkaart zie p. 16

**SPECIAAL**

- 2 uitvoeringen mogelijk, R150 en R190

**BEVESTIGINGEN**

- Muurbevestigingen standaard

**TECHNISCH**

- Elektrisch lasergelast (onzichtbare lasnaden)
- KTL-grondlaag, poedercoating
- Standaardwerkdruk: 4 bar
- Maximale bedrijfstemperatuur: 110°C

**ELEKTRISCH** (zie hoofdstuk elektrische radiatoren)

- ✗ Zuiver elektrische radiator in de fabriek vorgevuld
- ✗ Gemengde radiator

**TECHNISCHE TEKENINGEN**

- Zie p. 120

**AANSLUITING**

- ✗ Eénpuntsaansluiting voor éénpijpsysteem
- ✗ Eénpuntsaansluiting voor tweepijpsysteem
- ✗ Tweepuntsaansluiting voor éénpijpsysteem
- ✓ Tweepuntsaansluiting voor tweepijpsysteem (standaard) (zie p. 300)
- ✗ Geïntegreerd ventiel



**AANBEVOLEN AANSLUITING (0018)**

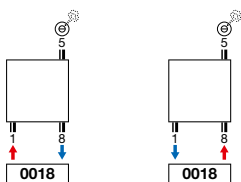

art. nr. 118210100000099

**prijs € 155**

Koppelingen, zie p. 313

**AANBEVOLEN VOOR BADKAMER  
IN OPTIE**



handdoekbeugel rond (aluminium)  
art. nr. 118323200000000 (393 mm)  
**prijs € 201**

**Andere accessoires, zie p. 116**

**OVER ZANA HALFROND**

**Scoort in alle richtingen**

De Zana Half rond boetseert de tijdloze lijnvoering van het Zana design tot een decoratief geheel dat ook in een strakke omgeving prima tot zijn recht komt. Een radiator die in no time de gewenste warmte levert in de hele omgeving. Ook leverbaar met optionele, halfronde handdoekbeugel.



# ZANA HALFROND (ZV-O)



ZV-O

## HOE ZANA HALFROND BESTELLEN

Leveringstermijn 15 - 30 werkdagen  
(zonder transportduur)

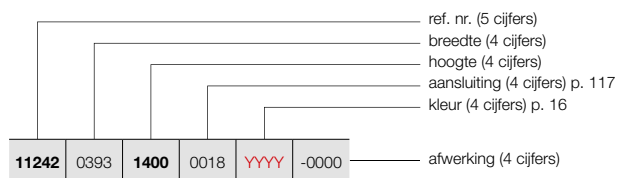

## HOE VOORRAADRADIATOR ZANA HALFROND BESTELLEN

Leveringstermijn 5 werkdagen  
(zonder transportduur)

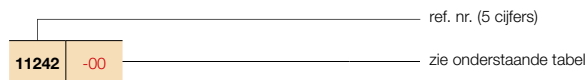

BESTELCODE MAATWERK ZANA HALFROND	TECHNISCHE GEGEVENS									STANDAARDKLEUR		ANDERE KLEUREN						
	buizen	breedte (L mm)	hoogte (H mm)	75/65/20 (Watt)	55/45/20 (Watt)	n-exp.	gewicht (kg)	inhoud (l)	el. weerst. (Watt)	prijs RAL 9016	verkorte ref. nr. RAL 9016 voorraad	prijs kleur	verkorte ref. nr. M301 voorraad					
<b>REF. NR. ZANA HALFROND ZV-O : 11242</b>																		
<b>11242</b>	0393	<b>1400</b>	0018	YYY	-0000	16	393	1400	1294	680	1,26	36,70	16,50	-	<b>632</b>	-	<b>727</b>	-
		<b>1800</b>				16	393	1800	1610	846	1,26	45,40	23,45	-	<b>779</b>	<b>11242-02</b>	<b>896</b>	<b>11242-01</b>
		<b>2000</b>				16	393	2000	1758	924	1,26	49,75	26,93	-	<b>841</b>	-	<b>967</b>	-
		<b>2200</b>				16	393	2200	1901	999	1,26	54,10	30,40	-	<b>904</b>	-	<b>1040</b>	-
<b>11242</b>	0473	<b>1400</b>	0018	YYY	-0000	20	473	1400	1684	885	1,26	43,95	20,65	-	<b>768</b>	-	<b>883</b>	-
		<b>1800</b>				20	473	1800	2094	1111	1,24	55,35	26,15	-	<b>957</b>	-	<b>1101</b>	-
		<b>2000</b>				20	473	2000	2287	1214	1,24	61,05	28,90	-	<b>1034</b>	-	<b>1189</b>	-
		<b>2200</b>				20	473	2200	2473	1319	1,23	66,75	31,65	-	<b>1113</b>	-	<b>1280</b>	-

CE 05 conform EN442-1: radiatoren en convectoren

Voor de warmteafgiftes van andere regimes, kijkt u op p. 308 (correctiefactoren)  
Prijzen in euro (excl. BTW)

**BUIZEN**

- Verticaal, rechthoekig 45 x 20 mm

**COLLECTOREN**

- Horizontaal, achterliggend, rond Ø 35 mm

**KLEUREN**

- Standaardkleur wit RAL 9016
- Niet verkrijgbaar in kleur Gloss White
- Uitgebreide kleurenkaart zie p. 16

**SPECIAAL**

- 2 uitvoeringen mogelijk, R150 en R190

**BEVESTIGINGEN**

- Muurbevestigingen standaard

**TECHNISCH**

- Elektrisch lasergelast (onzichtbare lasnaden)
- KTL-grondlaag, poedercoating
- Standaardwerkdruk: 4 bar
- Maximale bedrijfstemperatuur: 110°C

**ELEKTRISCH** (zie hoofdstuk elektrische radiatoren)

- ✗ Zuiver elektrische radiator in de fabriek vorgevuld
- ✗ Gemengde radiator

**TECHNISCHE TEKENINGEN**

- Zie p. 120

**AANSLUITING**

- ✗ Eénpuntsaansluiting voor éénpijpsysteem
- ✗ Eénpuntsaansluiting voor tweepijpsysteem
- ✗ Tweepuntsaansluiting voor éénpijpsysteem
- ✓ Tweepuntsaansluiting voor tweepijpsysteem (standaard) (zie p. 300)
- ✗ Geïntegreerd ventiel



**AANBEVOLEN AANSLUITING (0018)**

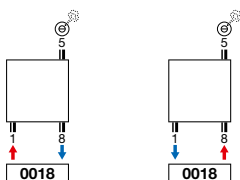

art. nr. 118210100000099  
**prijs € 155**  
 Koppelingen, zie p. 313

**AANBEVOLEN VOOR BADKAMER  
 IN OPTIE**



handdoekbeugel rond (aluminium)  
 art. nr. 118323000000000 (268 mm)  
**prijs € 201**

**Andere accessoires, zie p. 116**

**OVER ZANA KWARTROND**

**Mooie warmte, die graag in de hoek staat**

De Zana Kwartrond vormt het typische Zana design om tot een soepele structuur die de woonomgeving en zeker de private ruimte een extra dimensie geeft. De Zana Kwartrond is speciaal ontwikkeld om in een hoek geplaatst te worden. Vormgeving en vermogen zijn perfect op elkaar afgestemd. Net als bij de halfronde versie kan een passende handboekbeugel optioneel worden bijgeleverd.





## ZANA KWARTROND (ZV-A)



ZV-A

### HOE ZANA KWARTROND BESTELLEN

Leveringstermijn 15 - 30 werkdagen  
(zonder transportduur)

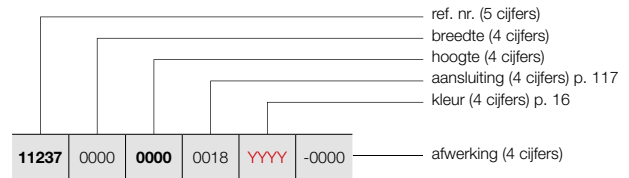

### HOE VOORRAADRADIATOR ZANA KWARTROND BESTELLEN

Leveringstermijn 5 werkdagen  
(zonder transportduur)

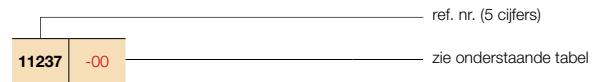

BESTELCODE MAATWERK ZANA KWARTROND	TECHNISCHE GEGEVENS									STANDAARDKLEUR		ANDERE KLEUREN					
	buizen	breedte (L mm)	hoogte (H mm)	75/65/20 (Watt)	55/45/20 (Watt)	n-exp.	gewicht (kg)	inhoud (l)	el. weerst. (Watt)	prijs RAL 9016	verkorte ref. nr. RAL 9016 voorraad	prijs kleur					
REF. NR. ZANA KWARTROND ZV-A : 11237																	
<b>11237</b>	0268	<b>1200</b>	0018	<b>YYYY</b>	-0000	8	268	1200	588	309	1,26	15,60	7,10	-	<b>470</b>	-	<b>541</b>
		<b>1400</b>				8	268	1400	672	353	1,26	17,85	8,25	-	<b>480</b>	-	<b>552</b>
		<b>1800</b>				8	268	1800	840	439	1,27	22,35	10,55	-	<b>551</b>	-	<b>634</b>
		<b>2000</b>				8	268	2000	923	480	1,28	24,60	11,70	-	<b>592</b>	-	<b>681</b>
		<b>2200</b>				8	268	2200	1007	524	1,28	26,85	12,85	-	<b>633</b>	-	<b>728</b>
<b>11237</b>	0322	<b>1200</b>	0018	<b>YYYY</b>	-0000	10	322	1200	751	395	1,26	20,05	8,88	-	<b>577</b>	-	<b>664</b>
		<b>1400</b>				10	322	1400	857	450	1,26	22,90	10,30	-	<b>588</b>	-	<b>676</b>
		<b>1800</b>				10	322	1800	1071	566	1,25	28,60	13,15	-	<b>666</b>	<b>11237-01</b>	<b>766</b>
		<b>2000</b>				10	322	2000	1177	622	1,25	31,45	14,58	-	<b>717</b>	-	<b>825</b>
		<b>2200</b>				10	322	2200	1283	678	1,25	34,30	16,00	-	<b>768</b>	-	<b>883</b>

CE<sub>05</sub> conform EN442-1: radiatoren en convectoren

Voor de warmteafgiftes van andere regimes, kijkt u op p. 308 (correctiefactoren)  
Prijzen in euro (excl. BTW)



**BUIZEN**

- Horizontaal, rechthoekig 45 x 20 mm

**COLLECTOREN**

- Verticaal, achterliggend, rond Ø 35 mm

**KLEUREN**

- Standaardkleur wit RAL 9016
- Niet verkrijgbaar in kleur Gloss White
- Uitgebreide kleurenkaart zie p. 16

**BEVESTIGINGEN**

- Muurbevestigingen standaard

**TECHNISCH**

- Elektrisch lasergelast (onzichtbare lasnaden)
- KTL-grondlaag, poedercoating
- Standaardwerkdruk: 4 bar
- Maximale bedrijfstemperatuur: 110°C

**ELEKTRISCH** (zie hoofdstuk elektrische radiatoren)

- ✓ Zuiver elektrische radiator in de fabriek gevuld
- ✓ Gemengde radiator

**TECHNISCHE TEKENINGEN**

- Zie p. 121

**AANSLUITING**

- ✗ Eénpuntsaansluiting voor éénpijpsysteem
  - ✗ Eénpuntsaansluiting voor tweepijpsysteem
  - ✓ Tweepuntsaansluiting voor éénpijpsysteem (aansluiting via de middenaansluiting (zie p. 300))
  - ✓ Tweepuntsaansluiting voor tweepijpsysteem (standaard) (zie p. 300)
  - ✗ Geïntegreerd ventiel
- Voor bovenaansluiting 45, 54 dient men een speciale stromingsbuis bij te bestellen die in de retour geplaatst dient te worden, zie p. 303.



VASCO

STAAL DESIGNRADIATOREN

**AANBEVOLEN AANSLUITING (1188)**

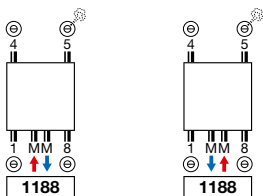

Andere aansluitmogelijkheden, zie p. 117

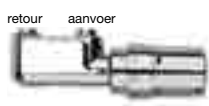

art. nr. 118210300000099  
prijs € 155  
Koppelingen, zie p. 313

**AANBEVOLEN VOOR BADKAMER IN OPTIE**



handdoekbeugel recht (chrom) art. nr. 118322800000099  
prijs € 166

Andere accessoires, zie p. 116

**OVER ZANA BAD**

**Warmte in haar zuiverste vorm**

De Zana Bad is een radiatorconcept dat traditie en trends verenigt in een uitermate pure vormgeving. Een comfortoplossing die in alle opzichten perfect tot haar recht komt dankzij de praktische, geïntegreerde middenaansluiting. De tijdloze, transparante structuur en het uitgepuurd design maken de Zana Bad tot een gewild object, ook in kleinere badkamers.



## ZANA BAD (ZBD)



ZBD

### HOE ZANA BAD BESTELLEN

Leveringstermijn 15 - 30 werkdagen  
(zonder transportduur)

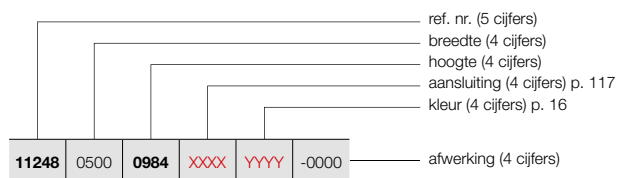

### HOE VOORRAADRADIATOR ZANA BAD BESTELLEN

Leveringstermijn 5 werkdagen  
(zonder transportduur)

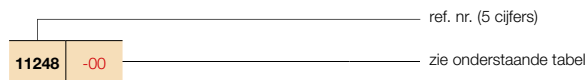

BESTELCODE MAATWERK ZANA BAD	TECHNISCHE GEGEVENS									STANDAARDKLEUR		ANDERE KLEUREN						
	buizen	breedte (L mm)	hoogte (H mm)	75/65/20 (Watt)	55/45/20 (Watt)	n-exp.	gewicht (kg)	inhoud (l)	el. weerst. (Watt)	prijs RAL 9016	verkorte ref. nr. RAL 9016 voorraad	prijs kleur	verkorte ref. nr. M301 voorraad					
<b>REF. NR. ZANA BAD ZBD : 11248</b>																		
<b>11248</b>	0500	<b>0984</b>	<b>XXXX</b>	<b>YYYY</b>	-0000	21	500	984	658	360	1,18	19,35	8,80	500	<b>555</b>	-	<b>638</b>	-
		<b>1504</b>				32	500	1504	976	531	1,19	29,45	12,35	1000	<b>809</b>	<b>11248-01</b>	<b>930</b>	<b>11248-02</b>
		<b>1824</b>				40	500	1824	1189	647	1,19	35,67	14,53	1250	<b>999</b>	<b>11248-03</b>	<b>1149</b>	<b>11248-04</b>
<b>11248</b>	0600	<b>0984</b>	<b>XXXX</b>	<b>YYYY</b>	-0000	21	600	984	788	436	1,16	22,10	10,40	750	<b>582</b>	-	<b>669</b>	-
		<b>1504</b>				32	600	1504	1151	633	1,17	33,70	15,80	1250	<b>852</b>	<b>11248-05</b>	<b>980</b>	<b>11248-08</b>
		<b>1824</b>				40	600	1824	1383	757	1,18	40,84	19,12	1500	<b>1058</b>	<b>11248-06</b>	<b>1217</b>	<b>11248-07</b>

CE<sub>05</sub> conform EN442-1: radiatoren en convectoren

Voor de warmteafgifte van andere regimes, kijkt u op p. 308 (correctiefactoren)  
Prijzen in euro (excl. BTW)

**TYPES**

- Eén (Multi 1) of twee rijen buizen (Multi 2)

**BUIZEN**

- Verticaal, rechthoekig 45 x 20 mm

**COLLECTOREN**

- Horizontaal, achterliggend, rond Ø 35 mm

**KLEUREN**

- Standaardkleur wit RAL 9016
- Niet verkrijgbaar in collecties Blue Green / Terra Cotta / Uni Colours
- Niet verkrijgbaar in kleuren S600, Gloss White en Jet Black
- Uitgebreide kleurenkaart zie p. 16

**SPECIAAL**

- De Zana-Multi 1 is samengesteld uit 1 enkele rij verticale buizen met een extra buis aan zowel de linker- als rechterzijde.

**BEVESTIGINGEN**

- Muurbevestigingen standaard

**TECHNISCH**

- Elektrisch lasergelast (onzichtbare lasnaden)
- KTL-grondlaag, poedercoating
- Standaardwerkdruk: 4 bar
- Maximale bedrijfstemperatuur: 110°C

**ELEKTRISCH** (zie hoofdstuk elektrische radiatoren)

- ✗ Zuiver elektrische radiator in de fabriek gevuld
- ✗ Gemengde radiator

**TECHNISCHE TEKENINGEN**

- Zie p. 121

**AANSLUITING**

- ✗ Eénpuntsaansluiting voor éénpijpsysteem
- ✗ Eénpuntsaansluiting voor tweepijpsysteem
- ✗ Tweepuntsaansluiting voor éénpijpsysteem
- ✓ Tweepuntsaansluiting voor tweepijpsysteem (standaard) (zie p. 300)
- ✗ Geïntegreerd ventiel

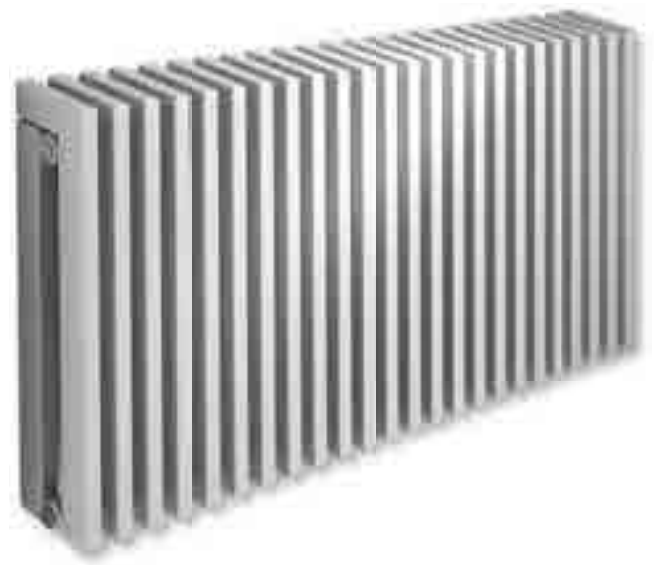

**AANBEVOLEN AANSLUITING (0018)**

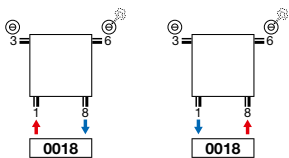

Andere aansluitmogelijkheden, zie p. 118



art. nr. 118210100000099

**prijs € 155**

Koppelingen, zie p. 313

**AANBEVOLEN VOOR BADKAMER IN OPTIE**



handdoekbeugel recht (chrom)

art. nr. 118322800000099

**prijs € 166**

Andere accessoires, zie p. 116

**OVER ZANA MULTI**

**Een meerwaarde in elke omgeving**

De Zana Multi combineert 1 of 2 verticale buizenrijen tot een harmonisch horizontaal geheel. De trendy vormgeving met verwijzing naar de traditionele radiatorstructuur is een meerwaarde in elke woonomgeving. Met de garantie van een onklopbaar vermogen en een verwarmingscomfort op maat van elke ruimte.



# ZANA MULTI (MULTI 1)



MULTI 1

## HOE ZANA MULTI BESTELLEN

Leveringstermijn 15 - 30 werkdagen  
(zonder transportduur)

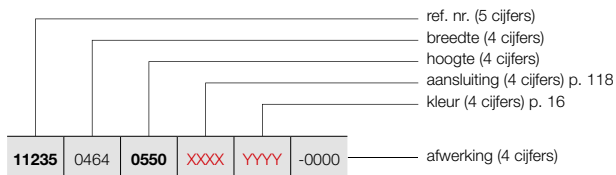

BESTELCODE MAATWERK ZANA MULTI							TECHNISCHE GEGEVENS				STANDAARDKLEUR	ANDERE KLEUREN					
REF. NR.	ZANA MULTI	MULTI 1	11235				buizen	breedte (L mm)	hoogte (H mm)	75/65/20 (Watt)	55/45/20 (Watt)	n-exp.	gewicht (kg)	inhoud (l)	el. weerst. (Watt)	prijs RAL 9016	prijs kleur
11235	0464	0550	XXXX	YYYY	-0000		12	464	550	520	276	1,24	12,96	5,88	-	581	668
		0650					12	464	650	592	313	1,25	14,76	6,84	-	624	718
		0750					12	464	750	664	351	1,25	16,44	7,68	-	659	758
11235	0544	0550	XXXX	YYYY	-0000		14	544	550	606	322	1,24	15,12	6,86	-	654	752
		0650					14	544	650	691	365	1,25	17,22	7,98	-	704	810
		0750					14	544	750	775	409	1,25	19,18	8,96	-	746	858
11235	0624	0550	XXXX	YYYY	-0000		16	624	550	693	368	1,24	17,28	7,84	-	727	836
		0650					16	624	650	790	417	1,25	19,68	9,12	-	785	903
		0750					16	624	750	886	468	1,25	21,92	10,24	-	833	958
11235	0704	0550	XXXX	YYYY	-0000		18	704	550	779	413	1,24	19,44	8,82	-	800	920
		0650					18	704	650	889	469	1,25	22,14	10,26	-	866	996
		0750					18	704	750	997	526	1,25	24,66	11,52	-	920	1058
11235	0784	0550	XXXX	YYYY	-0000		20	784	550	866	460	1,24	21,60	9,80	-	874	1005
		0650					20	784	650	987	521	1,25	24,60	11,40	-	946	1088
		0750					20	784	750	1107	585	1,25	27,40	12,80	-	1007	1158
11235	0864	0550	XXXX	YYYY	-0000		22	864	550	953	506	1,24	23,76	10,78	-	947	1089
		0650					22	864	650	1086	573	1,25	27,06	12,54	-	1027	1181
		0750					22	864	750	1218	643	1,25	30,14	14,08	-	1094	1258
11235	0944	0550	XXXX	YYYY	-0000		24	944	550	1039	551	1,24	25,92	11,76	-	1020	1173
		0650					24	944	650	1185	626	1,25	29,52	13,68	-	1108	1274
		0750					24	944	750	1329	702	1,25	32,88	15,36	-	1181	1358
11235	1024	0550	XXXX	YYYY	-0000		26	1024	550	1126	598	1,24	28,08	12,74	-	1094	1258
		0650					26	1024	650	1284	678	1,25	31,98	14,82	-	1188	1366
		0750					26	1024	750	1440	760	1,25	35,62	16,64	-	1268	1458
11235	1104	0550	XXXX	YYYY	-0000		28	1104	550	1212	643	1,24	30,24	13,72	-	1167	1342
		0650					28	1104	650	1382	730	1,25	34,44	15,96	-	1269	1459
		0750					28	1104	750	1550	819	1,25	38,36	17,92	-	1355	1558
11235	1184	0550	XXXX	YYYY	-0000		30	1184	550	1299	689	1,24	32,40	14,70	-	1240	1426
		0650					30	1184	650	1481	782	1,25	36,90	17,10	-	1350	1553
		0750					30	1184	750	1661	877	1,25	41,10	19,20	-	1442	1658
11235	1264	0550	XXXX	YYYY	-0000		32	1264	550	1386	736	1,24	34,56	15,68	-	1314	1511
		0650					32	1264	650	1580	834	1,25	39,36	18,24	-	1430	1645
		0750					32	1264	750	1772	936	1,25	43,84	20,48	-	1529	1758
11235	1424	0550	XXXX	YYYY	-0000		36	1424	550	1559	827	1,24	38,88	17,64	-	1460	1679
		0650					36	1424	650	1777	938	1,25	44,28	20,52	-	1592	1831
		0750					36	1424	750	1993	1052	1,25	49,32	23,04	-	1703	1958

CE 05 conform EN442-1: radiatoren en convectoren

Voor de warmteafgiftes van andere regimes, kijkt u op p. 308 (correctiefactoren)  
Prijzen in euro (excl. BTW)

## HOE ZANA MULTI BESTELLEN

Leveringstermijn 15 - 30 werkdagen  
(zonder transportduur)

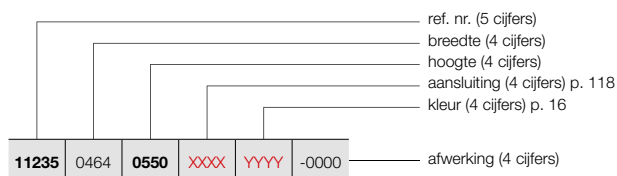

## ZANA MULTI (MULTI 1)



MULTI 1

BESTELCODE MAATWERK ZANA MULTI	TECHNISCHE GEGEVENS									STANDAARDKLEUR	ANDERE KLEUREN					
	buizen	breedte (L mm)	hoogte (H mm)	75/65/20 (Watt)	55/45/20 (Watt)	n-exp.	gewicht (kg)	inhoud (l)	el. weerst. (Watt)	prijs RAL 9016	prijs kleur					
<b>REF. NR. ZANA MULTI MULTI 1 : 11235</b>																
<b>11235</b>	1584	<b>0550</b>	<b>XXXX</b>	<b>YYYY</b>	-0000	40	1584	550	1732	919	1,24	43,20	19,60	-	<b>1607</b>	<b>1848</b>
		<b>0650</b>				40	1584	650	1975	1043	1,25	49,20	22,80	-	<b>1753</b>	<b>2016</b>
		<b>0750</b>				40	1584	750	2215	1170	1,25	54,80	25,60	-	<b>1877</b>	<b>2159</b>
<b>11235</b>	1744	<b>0550</b>	<b>XXXX</b>	<b>YYYY</b>	-0000	44	1744	550	1905	1011	1,24	47,52	21,56	-	<b>1753</b>	<b>2016</b>
		<b>0650</b>				44	1744	650	2172	1147	1,25	54,12	25,08	-	<b>1914</b>	<b>2201</b>
		<b>0750</b>				44	1744	750	2436	1286	1,25	60,28	28,16	-	<b>2051</b>	<b>2359</b>
<b>11235</b>	1904	<b>0550</b>	<b>XXXX</b>	<b>YYYY</b>	-0000	48	1904	550	2078	1103	1,24	51,84	23,52	-	<b>1900</b>	<b>2185</b>
		<b>0650</b>				48	1904	650	2370	1252	1,25	59,04	27,36	-	<b>2075</b>	<b>2386</b>
		<b>0750</b>				48	1904	750	2658	1404	1,25	65,76	30,72	-	<b>2225</b>	<b>2559</b>
<b>11235</b>	2064	<b>0550</b>	<b>XXXX</b>	<b>YYYY</b>	-0000	52	2064	550	2252	1195	1,24	56,16	25,48	-	<b>2047</b>	<b>2354</b>
		<b>0650</b>				52	2064	650	2567	1356	1,25	63,96	29,64	-	<b>2237</b>	<b>2573</b>
		<b>0750</b>				52	2064	750	2879	1520	1,25	71,24	33,28	-	<b>2398</b>	<b>2758</b>
<b>11235</b>	2224	<b>0550</b>	<b>XXXX</b>	<b>YYYY</b>	-0000	56	2224	550	2425	1287	1,24	60,48	27,44	-	<b>2193</b>	<b>2522</b>
		<b>0650</b>				56	2224	650	2765	1460	1,25	68,88	31,92	-	<b>2398</b>	<b>2758</b>
		<b>0750</b>				56	2224	750	3101	1638	1,25	76,72	35,84	-	<b>2572</b>	<b>2958</b>
<b>11235</b>	2384	<b>0550</b>	<b>XXXX</b>	<b>YYYY</b>	-0000	60	2384	550	2598	1379	1,24	64,80	29,40	-	<b>2340</b>	<b>2691</b>
		<b>0650</b>				60	2384	650	2962	1564	1,25	73,80	34,20	-	<b>2559</b>	<b>2943</b>
		<b>0750</b>				60	2384	750	3322	1754	1,25	82,20	38,40	-	<b>2746</b>	<b>3158</b>
<b>11235</b>	2544	<b>0550</b>	<b>XXXX</b>	<b>YYYY</b>	-0000	64	2544	550	2771	1471	1,24	69,12	31,36	-	<b>2487</b>	<b>2860</b>
		<b>0650</b>				64	2544	650	3160	1669	1,25	78,72	36,48	-	<b>2721</b>	<b>3129</b>
		<b>0750</b>				64	2544	750	3544	1871	1,25	87,68	40,96	-	<b>2920</b>	<b>3358</b>
<b>11235</b>	2704	<b>0550</b>	<b>XXXX</b>	<b>YYYY</b>	-0000	68	2704	550	2944	1563	1,24	73,44	33,32	-	<b>2633</b>	<b>3028</b>
		<b>0650</b>				68	2704	650	3357	1773	1,25	83,64	38,76	-	<b>2882</b>	<b>3314</b>
		<b>0750</b>				68	2704	750	3765	1988	1,25	93,16	43,52	-	<b>3094</b>	<b>3558</b>
<b>11235</b>	2864	<b>0550</b>	<b>XXXX</b>	<b>YYYY</b>	-0000	72	2864	550	3118	1655	1,24	77,76	35,28	-	<b>2780</b>	<b>3197</b>
		<b>0650</b>				72	2864	650	3555	1877	1,25	88,56	41,04	-	<b>3043</b>	<b>3499</b>
		<b>0750</b>				72	2864	750	3987	2105	1,25	98,64	46,08	-	<b>3268</b>	<b>3758</b>

CE 05 conform EN442-1: radiatoren en convectoren

Voor de warmteafgiftes van andere regimes, kijkt u op p. 308 (correctiefactoren)  
Prijzen in euro (excl. BTW)

# ZANA MULTI (MULTI 2)

## HOE ZANA MULTI BESTELLEN

Leveringstermijn 15 - 30 werkdagen  
(zonder transportduur)



MULTI 2

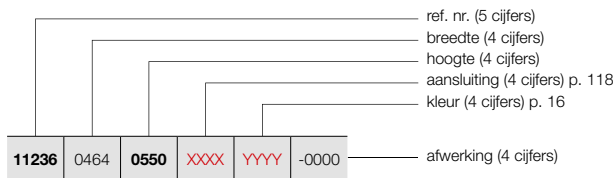

BESTELCODE MAATWERK ZANA MULTI							TECHNISCHE GEGEVENS					STANDAARDKLEUR	ANDERE KLEUREN			
buizen	breedte (L mm)	hoogte (H mm)	75/65/20 (Watt)	55/45/20 (Watt)	n-exp.	gewicht (kg)	inhoud (l)	el. weerst. (Watt)	prijs RAL 9016	prijs kleur						
REF. NR. ZANA MULTI MULTI 2 : 11236																
11236	0464	0550	XXXX	YYYY	-0000	12	464	550	739	384	1,28	21,96	9,96	-	872	1003
		0650				12	464	650	850	442	1,28	25,32	11,64	-	936	1076
		0750				12	464	750	960	499	1,28	28,68	13,32	-	989	1137
11236	0544	0550	XXXX	YYYY	-0000	14	544	550	862	448	1,28	25,62	11,62	-	981	1128
		0650				14	544	650	992	516	1,28	29,54	13,58	-	1056	1214
		0750				14	544	750	1120	582	1,28	33,46	15,54	-	1119	1287
11236	0624	0550	XXXX	YYYY	-0000	16	624	550	985	512	1,28	29,28	13,28	-	1091	1255
		0650				16	624	650	1134	590	1,28	33,76	15,52	-	1178	1355
		0750				16	624	750	1280	666	1,28	38,24	17,76	-	1250	1438
11236	0704	0550	XXXX	YYYY	-0000	18	704	550	1108	576	1,28	32,94	14,94	-	1200	1380
		0650				18	704	650	1276	664	1,28	37,98	17,46	-	1299	1494
		0750				18	704	750	1441	749	1,28	43,02	19,98	-	1380	1587
11236	0784	0550	XXXX	YYYY	-0000	20	784	550	1231	640	1,28	36,60	16,60	-	1311	1508
		0650				20	784	650	1417	737	1,28	42,20	19,40	-	1419	1632
		0750				20	784	750	1601	833	1,28	47,80	22,20	-	1511	1738
11236	0864	0550	XXXX	YYYY	-0000	22	864	550	1355	705	1,28	40,26	18,26	-	1421	1634
		0650				22	864	650	1559	811	1,28	46,42	21,34	-	1541	1772
		0750				22	864	750	1761	916	1,28	52,58	24,42	-	1641	1887
11236	0944	0550	XXXX	YYYY	-0000	24	944	550	1478	769	1,28	43,92	19,92	-	1530	1760
		0650				24	944	650	1701	885	1,28	50,64	23,28	-	1662	1911
		0750				24	944	750	1921	999	1,28	57,36	26,64	-	1772	2038
11236	1024	0550	XXXX	YYYY	-0000	26	1024	550	1601	833	1,28	47,58	21,58	-	1641	1887
		0650				26	1024	650	1843	958	1,28	54,86	25,22	-	1782	2049
		0750				26	1024	750	2081	1082	1,28	62,14	28,86	-	1902	2187
11236	1104	0550	XXXX	YYYY	-0000	28	1104	550	1724	897	1,28	51,24	23,24	-	1751	2014
		0650				28	1104	650	1984	1032	1,28	59,08	27,16	-	1904	2190
		0750				28	1104	750	2241	1165	1,28	66,92	31,08	-	2033	2338
11236	1184	0550	XXXX	YYYY	-0000	30	1184	550	1847	961	1,28	54,90	24,90	-	1860	2139
		0650				30	1184	650	2126	1106	1,28	63,30	29,10	-	2025	2329
		0750				30	1184	750	2401	1249	1,28	71,70	33,30	-	2163	2487
11236	1264	0550	XXXX	YYYY	-0000	32	1264	550	1970	1024	1,28	58,56	26,56	-	1971	2267
		0650				32	1264	650	2268	1179	1,28	67,52	31,04	-	2145	2467
		0750				32	1264	750	2561	1332	1,28	76,48	35,52	-	2294	2638
11236	1424	0550	XXXX	YYYY	-0000	36	1424	550	2217	1153	1,28	65,88	29,88	-	2190	2519
		0650				36	1424	650	2551	1327	1,28	75,96	34,92	-	2388	2746
		0750				36	1424	750	2881	1498	1,28	86,04	39,96	-	2555	2938
11236	1584	0550	XXXX	YYYY	-0000	40	1584	550	2463	1281	1,28	73,20	33,20	-	2411	2773
		0650				40	1584	650	2835	1474	1,28	84,40	38,80	-	2630	3025
		0750				40	1584	750	3201	1665	1,28	95,60	44,40	-	2816	3238

## HOE ZANA MULTI BESTELLEN

Leveringstermijn 15 - 30 werkdagen  
(zonder transportduur)

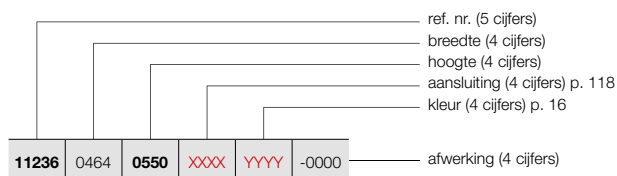

MULTI 2

BESTELCODE MAATWERK ZANA MULTI	TECHNISCHE GEGEVENS									STANDAARDKLEUR	ANDERE KLEUREN					
	buizen	breedte (L mm)	hoogte (H mm)	75/65/20 (Watt)	55/45/20 (Watt)	n-exp.	gewicht (kg)	inhoud (l)	el. weerst. (Watt)	prijs RAL 9016	prijs kleur					
<b>REF. NR. ZANA MULTI MULTI 2 : 11236</b>																
<b>11236</b>	1744	<b>0550</b>	<b>XXXX</b>	<b>YYYY</b>	-0000	44	1744	550	2709	1409	1,28	80,52	36,52	-	<b>2630</b>	<b>3025</b>
		<b>0650</b>				44	1744	650	3118	1621	1,28	92,84	42,68	-	<b>2871</b>	<b>3302</b>
		<b>0750</b>				44	1744	750	3521	1831	1,28	105,16	48,84	-	<b>3077</b>	<b>3539</b>
<b>11236</b>	1904	<b>0550</b>	<b>XXXX</b>	<b>YYYY</b>	-0000	48	1904	550	2955	1537	1,28	87,84	39,84	-	<b>2850</b>	<b>3278</b>
		<b>0650</b>				48	1904	650	3402	1769	1,28	101,28	46,56	-	<b>3113</b>	<b>3580</b>
		<b>0750</b>				48	1904	750	3841	1997	1,28	114,72	53,28	-	<b>3338</b>	<b>3839</b>
<b>11236</b>	2064	<b>0550</b>	<b>XXXX</b>	<b>YYYY</b>	-0000	52	2064	550	3202	1665	1,28	95,16	43,16	-	<b>3071</b>	<b>3532</b>
		<b>0650</b>				52	2064	650	3685	1916	1,28	109,72	50,44	-	<b>3356</b>	<b>3859</b>
		<b>0750</b>				52	2064	750	4162	2164	1,28	124,28	57,72	-	<b>3597</b>	<b>4137</b>
<b>11236</b>	2224	<b>0550</b>	<b>XXXX</b>	<b>YYYY</b>	-0000	56	2224	550	3448	1793	1,28	102,48	46,48	-	<b>3290</b>	<b>3784</b>
		<b>0650</b>				56	2224	650	3969	2064	1,28	118,16	54,32	-	<b>3597</b>	<b>4137</b>
		<b>0750</b>				56	2224	750	4482	2331	1,28	133,84	62,16	-	<b>3858</b>	<b>4437</b>
<b>11236</b>	2384	<b>0550</b>	<b>XXXX</b>	<b>YYYY</b>	-0000	60	2384	550	3694	1921	1,28	109,80	49,80	-	<b>3510</b>	<b>4037</b>
		<b>0650</b>				60	2384	650	4252	2211	1,28	126,60	58,20	-	<b>3839</b>	<b>4415</b>
		<b>0750</b>				60	2384	750	4802	2497	1,28	143,40	66,60	-	<b>4119</b>	<b>4737</b>
<b>11236</b>	2544	<b>0550</b>	<b>XXXX</b>	<b>YYYY</b>	-0000	64	2544	550	3940	2049	1,28	117,12	53,12	-	<b>3731</b>	<b>4291</b>
		<b>0650</b>				64	2544	650	4536	2359	1,28	135,04	62,08	-	<b>4082</b>	<b>4694</b>
<b>11236</b>	2704	<b>0550</b>	<b>XXXX</b>	<b>YYYY</b>	-0000	68	2704	550	4187	2177	1,28	124,44	56,44	-	<b>3950</b>	<b>4543</b>
		<b>0650</b>				68	2704	650	4819	2506	1,28	143,48	65,96	-	<b>4323</b>	<b>4971</b>
<b>11236</b>	2864	<b>0550</b>	<b>XXXX</b>	<b>YYYY</b>	-0000	72	2864	550	4433	2305	1,28	131,76	59,76	-	<b>4170</b>	<b>4796</b>

CE 05 conform EN442-1: radiatoren en convectoren

Voor de warmteafgiftes van andere regimes, kijkt u op p. 308 (correctiefactoren)  
Prijzen in euro (excl. BTW)



## ZANA PLINT (PLINTH)



### BUIZEN

- Horizontaal, rechthoekig 45 x 20 mm

### COLLECTOREN

- Verticaal, rond Ø 35 mm

### KLEUREN

- Standaardkleur wit RAL 9016
- Niet verkrijgbaar in kleur Gloss White
- Uitgebreide kleurenkaart zie p. 16

### BEVESTIGINGEN

- Voeten standaard

### TECHNISCH

- Elektrisch lasergelast (onzichtbare lasnaden)
- KTL-grondlaag, poedercoating
- Standaardwerkdruk: 4 bar
- Maximale bedrijfstemperatuur: 110°C

### ELEKTRISCH (zie hoofdstuk elektrische radiatoren)

- ✗ Zuiver elektrische radiator in de fabriek voorgevuld
- ✗ Gemengde radiator

### TECHNISCHE TEKENINGEN

- Zie p. 121

### AANSLUITING

- ✗ Eénpuntsaansluiting voor éénpijpsysteem
- ✗ Eénpuntsaansluiting voor tweepijpsysteem
- ✗ Tweepuntsaansluiting voor éénpijpsysteem
- ✓ Tweepuntsaansluiting voor tweepijpsysteem (standaard) (zie p. 300)
- ✗ Geïntegreerd ventiel

## OVER ZANA PLINT

### Een trapje hoger op de designladder

Een optimaal verwarmingscomfort in een tijdloze transparante structuur. De Zana Plint signeert de raampartijen in het interieur met een strakke, elegante lijnvoering. Een stijlvolle, eigentijdse beauty met een pure vintage look, waarop je nooit uitgekeken raakt. Strak waar het hoort, elegant waar het past en superieur in elk opzicht.

### AANBEVOLEN AANSLUITING (0018)

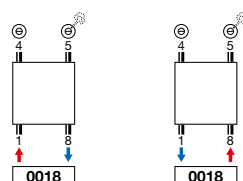

## HOE ZANA PLINT BESTELLEN

Leveringstermijn 15 - 30 werkdagen  
(zonder transportduur)

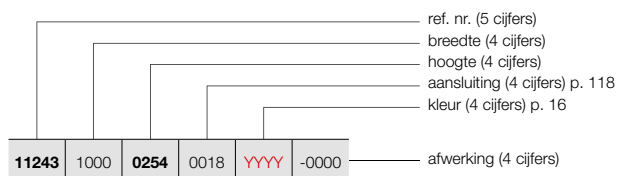

PLINTH

BESTELCODE MAATWERK ZANA PLINT	TECHNISCHE GEGEVENS										STANDAARDKLEUR	ANDERE KLEUREN				
	buizen	breedte (L mm)	hoogte (H mm)	75/65/20 (Watt)	55/45/20 (Watt)	n-exp.	gewicht (kg)	inhoud (l)	el. weerst. (Watt)	prijs RAL 9016	prijs kleur					
REF. NR. ZANA PLINT PLINTH : 11243																
11243	1000	0254	0018	YYYY	-0000	8	1000	254	462	246	1,23	13,21	4,86	-	369	424
11243	1200	0254	0018	YYYY	-0000	8	1200	254	554	296	1,23	15,85	5,83	-	385	443
11243	1400	0254	0018	YYYY	-0000	8	1400	254	647	345	1,23	18,49	6,80	-	424	488
11243	1600	0254	0018	YYYY	-0000	8	1600	254	739	394	1,23	21,14	7,78	-	462	531
11243	1800	0254	0018	YYYY	-0000	8	1800	254	832	444	1,23	23,78	8,75	-	501	576
11243	2000	0254	0018	YYYY	-0000	8	2000	254	924	493	1,23	26,42	9,72	-	540	621
11243	2200	0254	0018	YYYY	-0000	8	2200	254	1016	542	1,23	29,06	10,69	-	578	665
11243	2400	0254	0018	YYYY	-0000	8	2400	254	1109	592	1,23	31,70	11,66	-	617	710
11243	2600	0254	0018	YYYY	-0000	8	2600	254	1201	641	1,23	34,35	12,64	-	655	753
11243	2800	0254	0018	YYYY	-0000	8	2800	254	1294	690	1,23	36,99	13,61	-	694	798
11243	3000	0254	0018	YYYY	-0000	8	3000	254	1386	739	1,23	39,63	14,58	-	733	843

CE 05 conform EN442-1: radiatoren en convectoren

Voor de warmteafgiftes van andere regimes, kijkt u op p. 308 (correctiefactoren)  
Prijzen in euro (excl. BTW)

## ZANA VRIJSTAANDE OPSTELLING IN OPTIE

ACCESSOIRES		KLEUR	ART. NR.	€
VRIJSTAANDE OPSTELLING		<b>ZV-2</b>		
		RAL 9016	118100700009016	<b>62</b>
		KLEUR	11810070000xxxx	<b>71</b>
<ul style="list-style-type: none"> <li>Radiatoren in de kleur RAL 9016 en Pergamon krijgen 1 aparte zijbevestiging, 2 voeten (H=150 mm) en 2 rosetten in de betreffende kleur.</li> <li>Radiatoren in overige kleuren krijgen 1 aparte zijbevestiging en 2 voeten (H=150 mm) in de kleur van de radiator + 2 verchroomde rosetten.</li> </ul>				

## ZANA ACCESSOIRES IN OPTIE

ACCESSOIRES	BREEDTE RADIATOR	KLEUR	ART. NR.	€
<b>ZV-1 / ZV-2 / ZH-1 / ZH-2 / ZBD / MULTI 1 / MULTI 2</b>				
HANDDOEKBEUGEL RECHT		CHROOM	118322800000099	<b>166</b>
<ul style="list-style-type: none"> <li>h = 22 mm; b = 720 mm (zelf in te korten); d = 75 mm; a = 56 mm</li> </ul>				
<b>ZV-O</b>				
HANDDOEKBEUGEL ROND	393 mm	ALUMINIUM	118323200000000	<b>201</b>
	473 mm	ALUMINIUM	118323300000000	<b>201</b>
<ul style="list-style-type: none"> <li>Handdoekbeugel rond ZV-O 393 mm; h = 40 mm; b = 518 mm; d = 65 mm ; a = 50 mm</li> <li>Handdoekbeugel rond ZV-O 473 mm; h = 40 mm; b = 598 mm; d = 65 mm ; a = 50 mm</li> </ul>				
<b>ZV-A</b>				
HANDDOEKBEUGEL ROND	268 mm	ALUMINIUM	118323000000000	<b>201</b>
	322 mm	ALUMINIUM	118323100000000	<b>201</b>
<ul style="list-style-type: none"> <li>Handdoekbeugel rond ZV-A 268 mm; h = 40 mm; b = 335 mm; d = 65 mm ; a = 50 mm</li> <li>Handdoekbeugel rond ZV-A 322 mm; h = 40 mm; b = 386 mm; d = 65 mm ; a = 50 mm</li> </ul>				
<b>ZV-1 / ZV-2 / ZH-1 / ZH-2 / ZV-O / ZV-A / ZBD / MULTI 1 / MULTI 2</b>				
KNOP O-RING		CHROOM	118360300000099	<b>28</b>
<ul style="list-style-type: none"> <li>h = 22 mm; b = 22 mm; d = 42 mm</li> </ul>				
<b>ZV-1 / ZV-2 / ZH-1 / ZH-2 / ZV-O / ZV-A / ZBD / MULTI 1 / MULTI 2</b>				
KNOP BREDE GLEUF		CHROOM	118340300000099	<b>28</b>
<ul style="list-style-type: none"> <li>h = 22 mm; b = 22 mm; d = 42 mm</li> </ul>				

d = afstand voorkant accessoire tot voorkant radiator

a = afstand accessoire tot radiator

**uit voorraad leverbaar**

**ZANA VERTICAAL: ZV-1 / ZV-2 (VOORRAAD)**

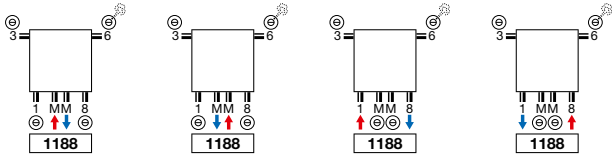

**ZANA HORIZONTAAL: ZH-1 / ZH-2**

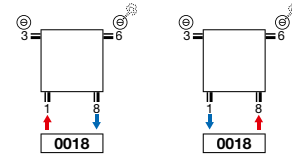

**ZANA VERTICAAL: ZV-1 / ZV-2 (NIET-VOORRAAD)**

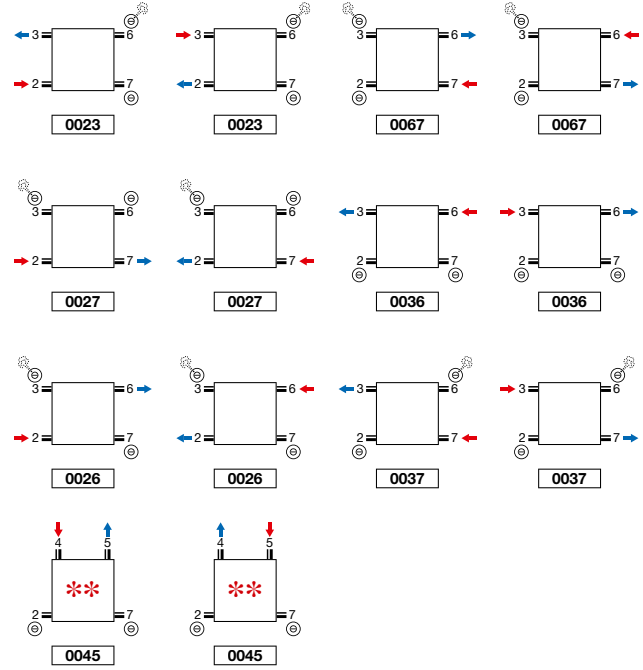
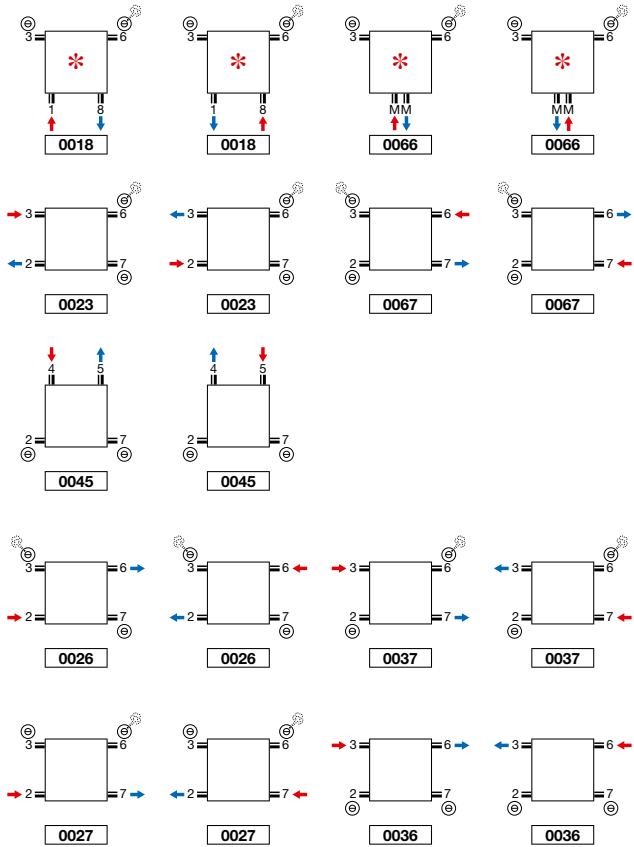

\*\* Niet voor ZH-1 toiletradiator.

\* Opmerking ZV-1/ZV-2 8 buizen: 2/3/6/7 altijd open.

**ZANA HALFROND: ZV-O / ZANA KWARTROND: ZV-A**

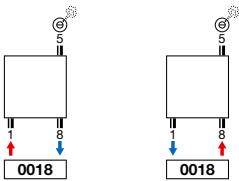

**ZANA BAD: ZBD (VOORRAAD) / ZBD (NIET-VOORRAAD)**

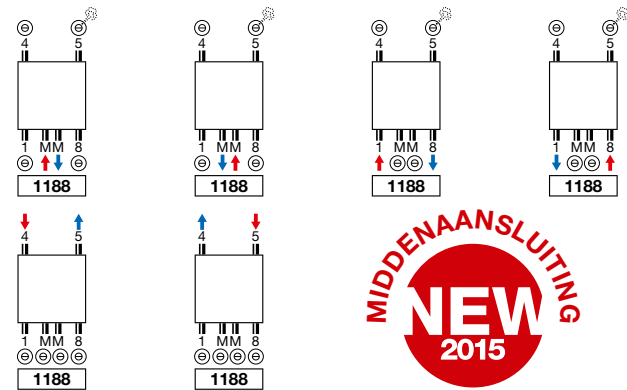

**ZANA BAD: ZBD (NIET-VOORRAAD)**

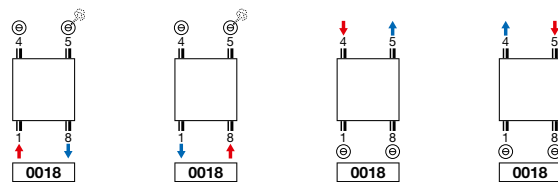

**Opmerking:** het aansluiten van de radiator kan enkel volgens de getoonde aansluiticonen. Voor elke andere aansluitwijze nemen wij geen verantwoordelijkheid.

ZANA MULTI: MULTI 1 / MULTI 2

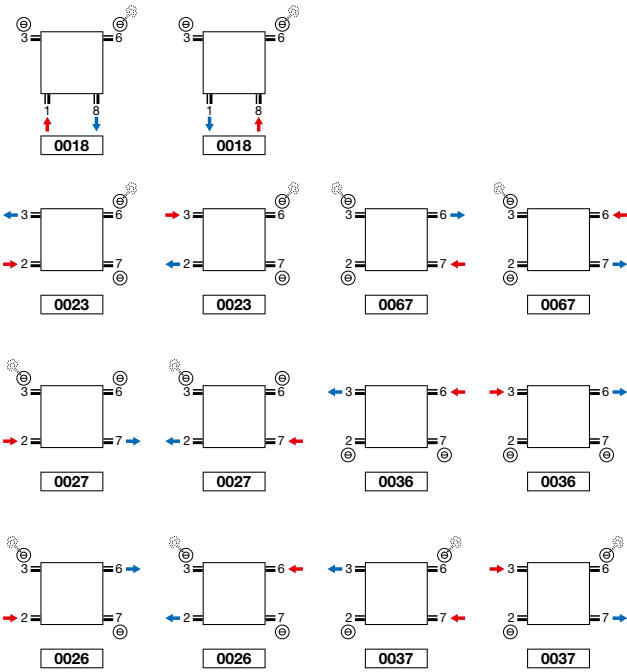

ZANA PLINT: PLINTH

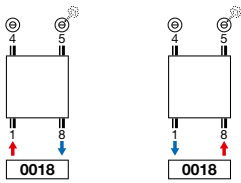

**Opmerking:** het aansluiten van de radiator kan enkel volgens de getoonde aansluiticonen. Voor elke andere aansluitwijze nemen wij geen verantwoordelijkheid.

**ZANA VERTICAAL (ZV-1, ZV-2)**

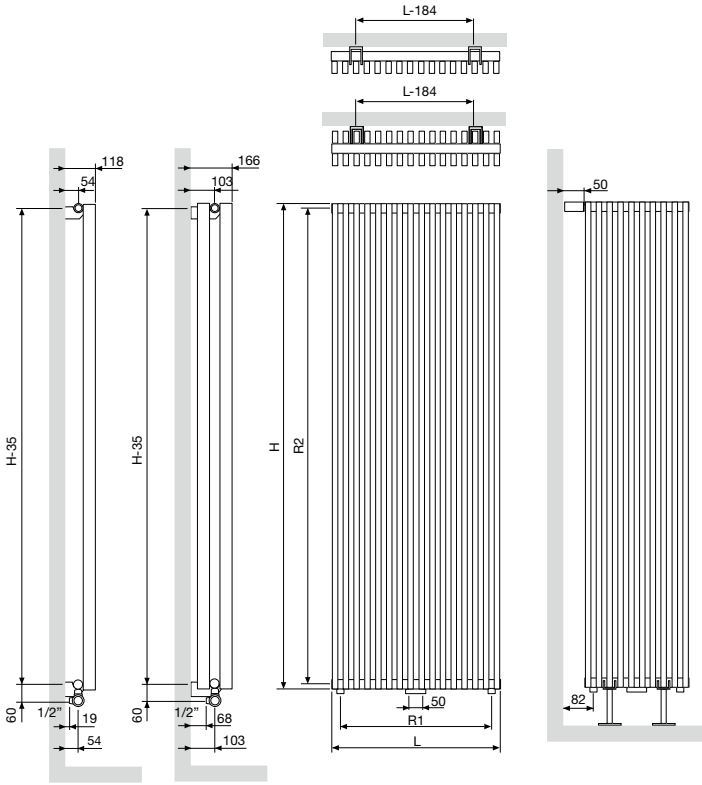

	<b>ZV-1 / ZV-2</b>										
Aantal buizen	8	10	12	14	16	18	20	22	24	26	
Breedte (L)	304	384	464	544	624	704	784	864	944	1024	
Hartafstand tussen de onderaansluitingen 18 (R1)	240	320	400	480	560	640	720	800	880	960	
Hoogte (H)	1400	1600	1800	2000	2200	2400	2600	2800	3000		
Hartafstand tussen de zijansluitingen 23/67 (R2)	1365	1565	1765	1965	2165	2365	2565	2765	2965		
Hartafstand tussen de ophangingen	L-184	H-35									

**ZANA HORIZONTAAL (ZH-1, ZH-2)**

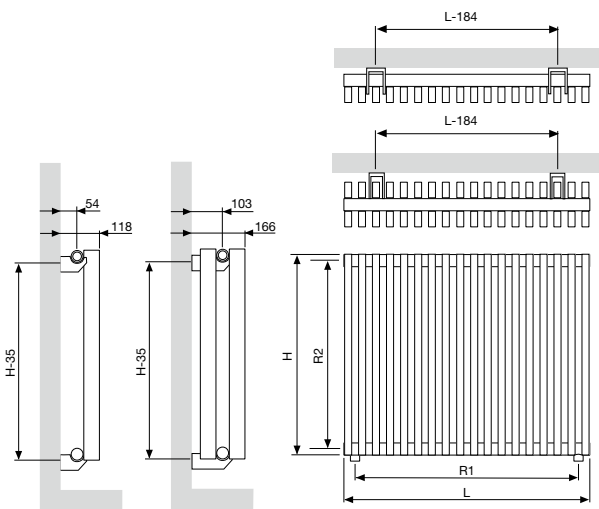

	<b>ZH-1 / ZH-2</b>																		
Breedte (L)	384	704	784	864	944	1024	1104	1184	1264	1424	1584	1744	1904	2064	2224	2384	2544	2704	2864
Hartafstand tussen de onderaansluitingen 18 (R1)	320	640	720	800	880	960	1040	1120	1200	1360	1520	1680	1840	2000	2160	2320	2480	2640	2800
Hoogte (H)	500	600	700																
Hartafstand tussen de zijansluitingen 23/67 (R2)	465	565	665																
Hartafstand tussen de ophangingen	L-184	H-35																	

ZANA HALFROND (ZV-O)

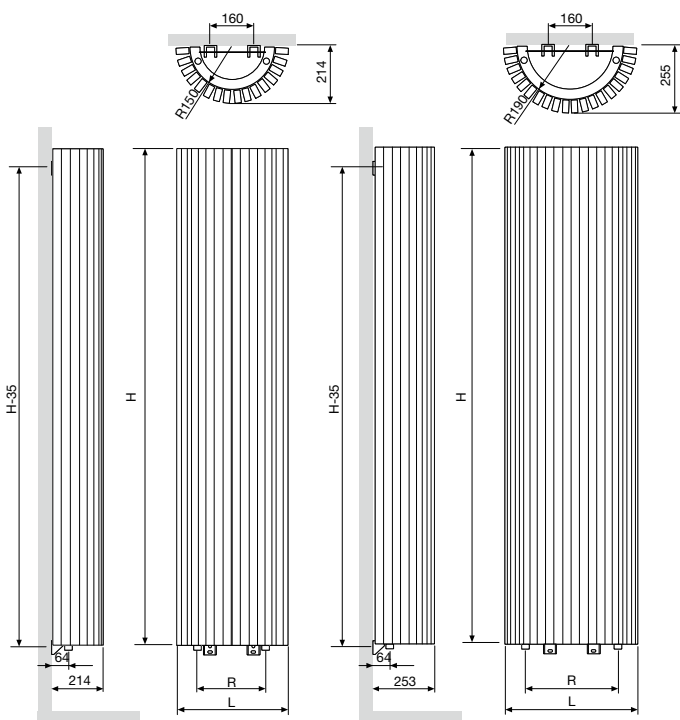

	ZV-O	
Breedte (L)	393	473
Hartafstand tussen de onderaansluitingen 18 (R)	249	333
Hartafstand tussen de ophangingen	H-35	

ZANA KWARTTROND (ZV-A)

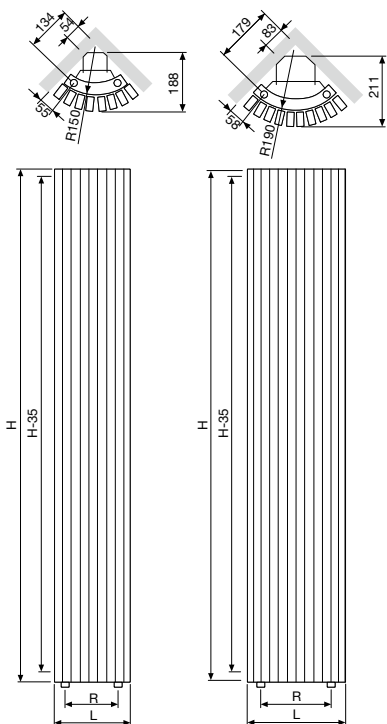

	ZV-A	
Breedte (L)	268	322
Hartafstand tussen de onderaansluitingen 18 (R)	112	171
Hartafstand tussen de ophangingen	H-35	



**ZANA BAD (ZBD)**

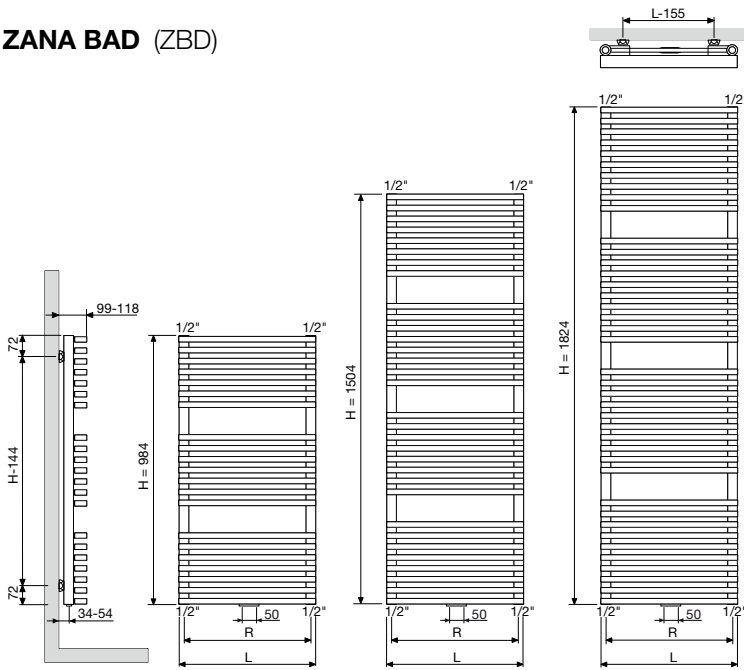

	<b>ZBD</b>	
Breedte (L)	500	600
Hartafstand tussen de onderaansluitingen 18 (R)	465	565
Hartafstand tussen de ophangingen	L-155	H-144

**ZANA MULTI (MULTI 1, MULTI 2)**

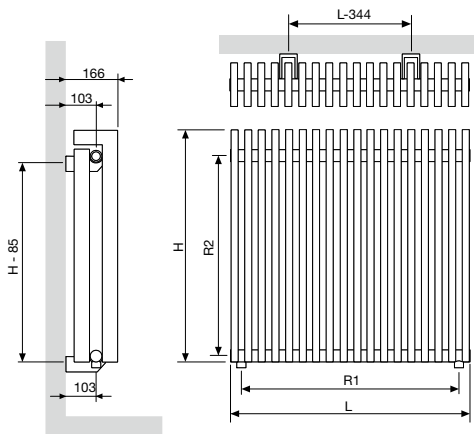

**ZANA MULTI**

Breedte (L)	464	544	624	704	784	864	944	1024	1104	1184	1264	1424	1584	1744	1904	2064	2224	2384	2544	2704	2864	
Hartafstand tussen de onderaansluitingen 18 (R1)	400	480	560	640	720	800	880	960	1040	1120	1200	1360	1520	1680	1840	2000	2160	2320	2480	2640	2800	
Hoogte (H)	550	650	750																			
Hartafstand tussen de zijansluitingen 23/67 (R2)	465	565	665																			
Hartafstand tussen de ophangingen	H-85		L-344																			

**ZANA PLINT (PLINTH)**

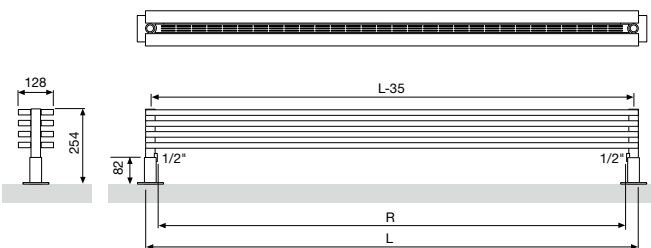

**PLINTH**

Breedte (L)	1000	1200	1400	1600	1800	2000	2200	2400	2600	2800	3000
Hartafstand tussen de onderaansluitingen 18 (R)	927	1127	1327	1527	1727	1927	2127	2327	2527	2727	2927



## VIOLA VERTICAAL (V1-ZB, V1L1-ZB, V2-ZB)



### OVER VIOLA VERTICAAL

#### In de soberheid toont zich de klasse

Een buizenradiator die naadloos combineert met elke woonstijl, door zijn sobere klasse en zijn vanzelfsprekend design. De strak gelijkende voorkant en de ingewerkte zijpanelen staan borg voor een uniforme look en een optimale warmteafgifte. Viola, zo simpel, krachtig en aantrekkelijk kan verwarmingscomfort zijn.

#### TYPES

- V1-ZB enkele rij buizen, V2-ZB dubbele rij buizen, V1L1-ZB met lamellen

#### BUIZEN

- Verticaal, platovaal 70 x 10 mm

#### COLLECTOREN

- Horizontaal, vierkant, achterliggend 34 x 34 mm

#### KLEUREN

- Standaardkleur wit RAL 9016
- Niet verkrijgbaar in kleuren Gloss White en Jet Black
- Uitgebreide kleurenkaart zie p. 16

#### SPECIAAL

- Bij type V1L1-ZB is 1 rij stalen lamellen ter verhoging van de warmteafgifte op de platovale buizen gepuntlast.
- Wordt standaard geleverd met 2 zijbekledingen.
- mm aansluiting alleen mogelijk bij even aantal buizen.

#### BEVESTIGINGEN

- Muurbevestigingen standaard
- V2-ZB ook verkrijgbaar als vrijstaande opstelling, zie p. 150.

#### TECHNISCH

- Weerstandsgelast (onzichtbare lasnaden)
- KTL-grondlaag, poedercoating
- Standaardwerkdruk: 4 bar. Meerprijs hogere werkdruk (10 bar): +10%
- De leveringstermijn van radiator met een hogere werkdruk is 1 week extra.
- Maximale bedrijfstemperatuur: 110°C

#### ELEKTRISCH (zie hoofdstuk elektrische radiatoren)

- ✓ Zuiver elektrische radiator in de fabriek voorgevuld
- ✗ Gemengde radiator

#### TECHNISCHE TEKENINGEN

- Zie p. 153

#### AANSLUITING

- ✓ Eénpuntsaansluiting voor éénpijpsysteem (radiator speciaal te bestellen) (zie p. 301)
- ✓ Eénpuntsaansluiting voor tweepijpsysteem (radiator speciaal te bestellen) (zie p. 301)
- ✓ Tweepuntsaansluiting voor éénpijpsysteem (aansluiting via de middenaansluiting) (zie p. 300)
- ✓ Tweepuntsaansluiting voor tweepijpsysteem (standaard) (zie p. 300)
- ✗ Geïntegreerd ventiel

#### AANBEVOLEN AANSLUITING (1008)

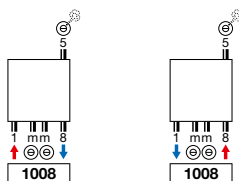

Andere aansluitmogelijkheden, zie p. 152



art. nr. 118200100009016  
prijs € 91

Koppelingen, zie p. 313

#### AANBEVOLEN VOOR BADKAMER IN OPTIE



handdoekbeugel (chromo)  
art. nr. 118322300000099  
prijs € 166

Andere accessoires, zie p. 151

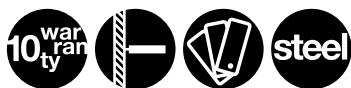

V2-ZB

## HOE VIOLA VERTICAAL BESTELLEN

Leveringstermijn 15 - 30 werkdagen  
(zonder transportduur)

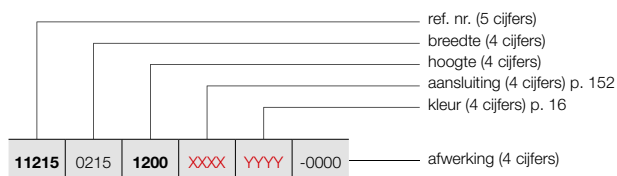

11215 0215 1200 XXXX YYYY -0000

## VIOLA VERTICAAL (V1-ZB)



V1-ZB

## HOE VOORRAADRADIATOR VIOLA VERTICAAL BESTELLEN

Leveringstermijn 5 werkdagen  
(zonder transportduur)

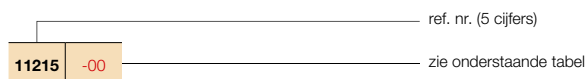

11215 -00

BESTELCODE MAATWERK VIOLA VERTICAAL	TECHNISCHE GEGEVENS									STANDAARDKLEUR		ANDERE KLEUREN	
	buizen	breedte (L mm)	hoogte (H mm)	75/65/20 (Watt)	55/45/20 (Watt)	n-exp.	gewicht (kg)	inhoud (l)	el. weerst. (Watt)	prijs RAL 9016	verkorte ref. nr. RAL 9016 voorraad	prijs kleur	
<b>REF. NR. VIOLA VERTICAAL V1-ZB : 11215</b>													
11215 0215 1200 XXXX YYYY -0000	1400	3	215	1200	300	151	1,35	7,86	2,10	-	241	-	277
	1600	3	215	1400	351	176	1,35	9,00	2,40	-	263	-	302
	1800	3	215	1600	401	202	1,34	10,14	2,67	-	284	-	327
	2000	3	215	1800	449	226	1,34	11,25	3,00	-	306	-	352
	2200	3	215	2000	495	250	1,34	12,36	3,33	-	327	-	376
	2400	3	215	2200	539	272	1,34	13,44	3,60	-	348	-	400
		3	215	2400	581	292	1,35	14,52	3,84	-	370	-	426
		4	288	1200	400	201	1,35	10,48	2,80	-	284	-	327
11215 0288 1200 XXXX YYYY -0000	1400	4	288	1400	468	235	1,35	12,00	3,20	-	311	-	358
	1600	4	288	1600	534	269	1,34	13,52	3,56	-	338	-	389
	1800	4	288	1800	598	302	1,34	15,00	4,00	-	365	-	420
	2000	4	288	2000	659	332	1,34	16,48	4,44	-	391	-	450
	2200	4	288	2200	718	362	1,34	17,92	4,80	-	418	-	481
	2400	4	288	2400	774	388	1,35	19,36	5,12	-	445	-	512
		5	360	1200	500	251	1,35	13,10	3,50	-	327	-	376
		5	360	1400	585	294	1,35	15,00	4,00	-	359	-	413
11215 0360 1200 XXXX YYYY -0000	1600	5	360	1600	668	337	1,34	16,90	4,45	-	391	-	450
	1800	5	360	1800	748	377	1,34	18,75	5,00	-	423	-	486
	2000	5	360	2000	824	416	1,34	20,60	5,55	-	456	-	524
	2200	5	360	2200	898	453	1,34	22,40	6,00	-	488	-	561
	2400	5	360	2400	968	486	1,35	24,20	6,40	-	520	-	598
		6	433	1200	600	301	1,35	15,72	4,20	-	370	-	426
		6	433	1400	702	352	1,35	18,00	4,80	-	407	-	468
		6	433	1600	801	404	1,34	20,28	5,34	-	445	-	512
11215 0433 1200 XXXX YYYY -0000	1800	6	433	1800	897	452	1,34	22,50	6,00	-	483	-	555
	2000	6	433	2000	989	499	1,34	24,72	6,66	-	520	-	598
	2200	6	433	2200	1077	543	1,34	26,88	7,20	-	558	-	642
	2400	6	433	2400	1161	583	1,35	29,04	7,68	-	595	-	684
		7	505	1200	700	351	1,35	18,34	4,90	-	413	-	475
		7	505	1400	819	411	1,35	21,00	5,60	-	455	-	523
		7	505	1600	935	472	1,34	23,66	6,23	-	499	-	574
		7	505	1800	1047	528	1,34	26,25	7,00	-	542	-	623
11215 0505 1200 XXXX YYYY -0000	2000	7	505	2000	1154	582	1,34	28,84	7,77	-	585	-	673
	2200	7	505	2200	1257	634	1,34	31,36	8,40	-	627	-	721
	2400	7	505	2400	1355	680	1,35	33,88	8,96	-	671	-	772
		8	578	1200	800	401	1,35	20,96	5,60	-	455	-	523
		8	578	1400	936	470	1,35	24,00	6,40	-	504	-	580
		8	578	1600	1068	539	1,34	27,04	7,12	-	552	-	635
		8	578	1800	1196	603	1,34	30,00	8,00	-	600	11215-02	690
		8	578	2000	1319	665	1,34	32,96	8,88	-	649	11215-03	746
11215 0578 1200 XXXX YYYY -0000	2200	8	578	2200	1436	724	1,34	35,84	9,60	-	697	-	802
	2400	8	578	2400	1548	777	1,35	38,72	10,24	-	746	-	858

CE 05 conform EN442-1: radiatoren en convectoren

Voor de warmteafgiftes van andere regimes, kijkt u op p. 308 (correctiefactoren)  
Prijzen in euro (excl. BTW)

# VIOLA VERTICAAL (V1-ZB)



V1-ZB

**HOE VIOLA VERTICAAL BESTELLEN**  
Leveringstermijn 15 - 30 werkdagen  
(zonder transportduur)

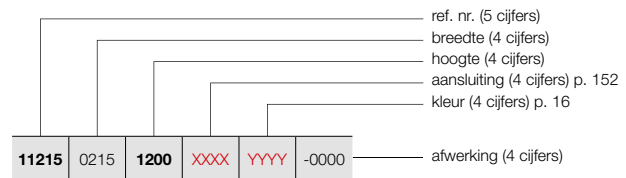

BESTELCODE MAATWERK VIOLA VERTICAAL							TECHNISCHE GEGEVENS							STANDAARDKLEUR		ANDERE KLEUREN			
11215	0215	1200	XXXX	YYYY	-0000		buizen	breedte (L mm)	hoogte (H mm)	75/65/20 (Watt)	55/45/20 (Watt)	n-exp.	gewicht (kg)	inhoud (l)	el. weerst. (Watt)	prijs RAL 9016	verkorte ref. nr. RAL 9016 voorraad	prijs kleur	
<b>REF. NR. VIOLA VERTICAAL V1-ZB : 11215</b>																			
11215	0650	1200	XXXX	YYYY	-0000		9	650	1200	899	451	1,35	23,58	6,30	-	499	-	574	
		1400					9	650	1400	1053	528	1,35	27,00	7,20	-	552	-	635	
		1600					9	650	1600	1202	606	1,34	30,42	8,01	-	606	-	697	
		1800					9	650	1800	1346	679	1,34	33,75	9,00	-	659	-	758	
		2000					9	650	2000	1484	748	1,34	37,08	9,99	-	714	-	821	
		2200					9	650	2200	1616	815	1,34	40,32	10,80	-	767	-	882	
		2400					9	650	2400	1742	874	1,35	43,56	11,52	-	821	-	944	
11215	0723	1200	XXXX	YYYY	-0000		10	723	1200	999	501	1,35	26,20	7,00	-	541	-	622	
		1400					10	723	1400	1170	587	1,35	30,00	8,00	-	600	-	690	
		1600					10	723	1600	1335	673	1,34	33,80	8,90	-	659	-	758	
		1800					10	723	1800	1495	754	1,34	37,50	10,00	-	719	-	827	
		2000					10	723	2000	1649	832	1,34	41,20	11,10	-	778	-	895	
		2200					10	723	2200	1795	905	1,34	44,80	12,00	-	837	-	963	
		2400					10	723	2400	1936	971	1,35	48,40	12,80	-	896	-	1030	
11215	0795	1200	XXXX	YYYY	-0000		11	795	1200	1099	551	1,35	28,82	7,70	-	584	-	672	
		1400					11	795	1400	1287	646	1,35	33,00	8,80	-	649	-	746	
		1600					11	795	1600	1469	741	1,34	37,18	9,79	-	713	-	820	
		1800					11	795	1800	1645	830	1,34	41,25	11,00	-	778	-	895	
		2000					11	795	2000	1813	914	1,34	45,32	12,21	-	843	-	969	
		2200					11	795	2200	1975	996	1,34	49,28	13,20	-	906	-	1042	
		2400					11	795	2400	2129	1068	1,35	53,24	14,08	-	971	-	1117	
11215	0868	1200	XXXX	YYYY	-0000		12	868	1200	1199	602	1,35	31,44	8,40	-	627	-	721	
		1400					12	868	1400	1404	704	1,35	36,00	9,60	-	696	-	800	
		1600					12	868	1600	1602	808	1,34	40,56	10,68	-	766	-	881	
		1800					12	868	1800	1794	905	1,34	45,00	12,00	-	836	-	961	
		2000					12	868	2000	1978	998	1,34	49,44	13,32	-	906	-	1042	
		2200					12	868	2200	2154	1086	1,34	53,76	14,40	-	976	-	1122	
		2400					12	868	2400	2323	1166	1,35	58,08	15,36	-	1046	-	1203	
11215	1013	1200	XXXX	YYYY	-0000		14	1013	1200	1399	702	1,35	36,68	9,80	-	713	-	820	
		1400					14	1013	1400	1638	822	1,35	42,00	11,20	-	793	-	912	
		1600					14	1013	1600	1870	943	1,34	47,32	12,46	-	873	-	1004	
		1800					14	1013	1800	2093	1056	1,34	52,50	14,00	-	955	-	1098	
		2000					14	1013	2000	2308	1164	1,34	57,68	15,54	-	1035	-	1190	
		2200					14	1013	2200	2514	1268	1,34	62,72	16,80	-	1117	-	1285	
		2400					14	1013	2400	2710	1360	1,35	67,76	17,92	-	1197	-	1377	

CE<sub>05</sub> conform EN442-1: radiatoren en convectoren

Voor de warmteafgiftes van andere regimes, kijkt u op p. 308 (correctiefactoren)  
Prijzen in euro (excl. BTW)

### HOE VIOLA VERTICAAL BESTELLEN

Leveringstermijn 15 - 30 werkdagen  
(zonder transportduur)

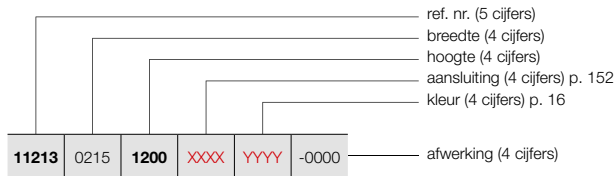

### VIOLA VERTICAAL (V1L1-ZB)



V1L1-ZB

### HOE VOORRAADRADIATOR VIOLA VERTICAAL BESTELLEN

Leveringstermijn 5 werkdagen  
(zonder transportduur)

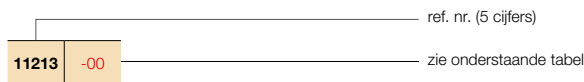

BESTELCODE MAATWERK VIOLA VERTICAAL							TECHNISCHE GEGEVENS						STANDAARDKLEUR		ANDERE KLEUREN		
							buizen	breedte (L mm)	hoogte (H mm)	75/65/20 (Watt)	55/45/20 (Watt)	n-exp.	gewicht (kg)	inhoud (l)	el. weerst. (Watt)	prijs RAL 9016	verkorte ref. nr. RAL 9016 voorraad
REF. NR. VIOLA VERTICAAL V1L1-ZB : 11213																	
11213	0215	1200	XXXX	YYYY	-0000	3	215	1200	421	211	1,35	10,65	2,04	-	302	-	347
		1400				3	215	1400	480	241	1,35	12,06	2,31	-	329	-	378
		1600				3	215	1600	538	270	1,35	13,47	2,61	-	355	-	408
		1800				3	215	1800	594	298	1,35	15,12	2,88	-	382	-	439
		2000				3	215	2000	649	326	1,35	16,77	3,15	-	408	-	469
		2200				3	215	2200	702	354	1,34	18,45	3,45	-	436	-	501
		2400				3	215	2400	754	382	1,33	20,19	3,75	-	462	-	531
		11213				0288	1200	XXXX	YYYY	-0000	4	288	1200	562	282	1,35	14,20
1400	4		288	1400	640		321				1,35	16,08	3,08	-	389	-	447
1600	4		288	1600	717		360				1,35	17,96	3,48	-	422	-	485
1800	4		288	1800	792		397				1,35	20,16	3,84	-	456	-	524
2000	4		288	2000	865		434				1,35	22,36	4,20	-	489	-	562
2200	4		288	2200	936		472				1,34	24,60	4,60	-	523	-	601
2400	4		288	2400	1006		510				1,33	26,92	5,00	-	556	-	639
11213	0360		1200	XXXX	YYYY		-0000				5	360	1200	702	352	1,35	17,75
		1400	5			360		1400	801	402	1,35	20,10	3,85	-	449	-	516
		1600	5			360		1600	897	450	1,35	22,45	4,35	-	489	-	562
		1800	5			360		1800	990	497	1,35	25,20	4,80	-	529	-	608
		2000	5			360		2000	1081	542	1,35	27,95	5,25	-	571	-	657
		2200	5			360		2200	1170	590	1,34	30,75	5,75	-	611	-	703
		2400	5			360		2400	1257	637	1,33	33,65	6,25	-	650	-	748
		11213	0433			0600		XXXX	YYYY	-0000	6	433	600	403	207	1,30	11,15
1200	6			433	1200	842	422				1,35	21,30	4,08	-	462	-	531
1400	6			433	1400	961	482				1,35	24,12	4,62	-	509	-	585
1600	6			433	1600	1076	540				1,35	26,94	5,22	-	556	-	639
1800	6			433	1800	1188	596				1,35	30,24	5,76	-	604	-	695
2000	6			433	2000	1297	651				1,35	33,54	6,30	-	650	-	748
2200	6			433	2200	1404	708				1,34	36,90	6,90	-	698	-	803
2400	6			433	2400	1508	764				1,33	40,38	7,50	-	745	-	857
11213	0505	1200	XXXX	YYYY	-0000	7	505	1200	983	493	1,35	24,85	4,76	-	516	-	593
		1400				7	505	1400	1121	562	1,35	28,14	5,39	-	570	-	656
		1600				7	505	1600	1255	630	1,35	31,43	6,09	-	623	-	716
		1800				7	505	1800	1386	695	1,35	35,28	6,72	-	678	-	780
		2000				7	505	2000	1513	759	1,35	39,13	7,35	-	731	-	841
		2200				7	505	2200	1638	826	1,34	43,05	8,05	-	784	-	902
		2400				7	505	2400	1760	892	1,33	47,11	8,75	-	838	-	964
		11213				0578	1200	XXXX	YYYY	-0000	8	578	1200	1123	563	1,35	28,40
1400	8		578	1400	1281		643				1,35	32,16	6,16	-	629	-	723
1600	8		578	1600	1434		720				1,35	35,92	6,96	-	690	-	794
1800	8		578	1800	1584		795				1,35	40,32	7,68	-	751	11213-01	864
2000	8		578	2000	1730		868				1,35	44,72	8,40	-	812	11213-02	934
2200	8		578	2200	1872		944				1,34	49,20	9,20	-	871	-	1002
2400	8		578	2400	2011		1019				1,33	53,84	10,00	-	932	-	1072

CE 05 conform EN442-1: radiatoren en convectoren

Voor de warmteafgiftes van andere regimes, kijkt u op p. 308 (correctiefactoren)  
Prijzen in euro (excl. BTW)

# VIOLA VERTICAAL (V1L1-ZB)

## HOE VIOLA VERTICAAL BESTELLEN

Leveringstermijn 15 - 30 werkdagen  
(zonder transportduur)



V1L1-ZB

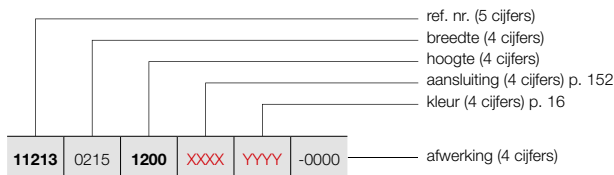

BESTELCODE MAATWERK VIOLA VERTICAAL							TECHNISCHE GEGEVENS						STANDAARDKLEUR		ANDERE KLEUREN		
REF. NR.	VIOLA VERTICAAL	V1L1-ZB	: 11213	buizen	breedte (L mm)	hoogte (H mm)	75/65/20 (Watt)	55/45/20 (Watt)	n-exp.	gewicht (kg)	inhoud (l)	el. weerst. (Watt)	prijs RAL 9016	verkorte ref. nr. RAL 9016 voorraad	prijs kleur		
11213	0650	1200	XXXX	YYYY	-0000	9	650	1200	1264	634	1,35	31,95	6,12	-	623	-	716
		1400				9	650	1400	1441	723	1,35	36,18	6,93	-	690	-	794
		1600				9	650	1600	1614	810	1,35	40,41	7,83	-	757	-	871
		1800				9	650	1800	1782	894	1,35	45,36	8,64	-	824	-	948
		2000				9	650	2000	1946	976	1,35	50,31	9,45	-	892	-	1026
		2200				9	650	2200	2106	1062	1,34	55,35	10,35	-	959	-	1103
		2400				9	650	2400	2263	1147	1,33	60,57	11,25	-	1026	-	1180
11213	0723	1200	XXXX	YYYY	-0000	10	723	1200	1404	704	1,35	35,50	6,80	-	676	-	777
		1400				10	723	1400	1601	803	1,35	40,20	7,70	-	751	-	864
		1600				10	723	1600	1793	900	1,35	44,90	8,70	-	824	-	948
		1800				10	723	1800	1980	994	1,35	50,40	9,60	-	899	-	1034
		2000				10	723	2000	2162	1085	1,35	55,90	10,50	-	972	-	1118
		2200				10	723	2200	2340	1180	1,34	61,50	11,50	-	1046	-	1203
		2400				10	723	2400	2514	1274	1,33	67,30	12,50	-	1121	-	1289
11213	0795	1200	XXXX	YYYY	-0000	11	795	1200	1544	775	1,35	39,05	7,48	-	730	-	840
		1400				11	795	1400	1761	884	1,35	44,22	8,47	-	812	-	934
		1600				11	795	1600	1972	989	1,35	49,39	9,57	-	891	-	1025
		1800				11	795	1800	2178	1093	1,35	55,44	10,56	-	972	-	1118
		2000				11	795	2000	2378	1193	1,35	61,49	11,55	-	1054	-	1212
		2200				11	795	2200	2574	1298	1,34	67,65	12,65	-	1133	-	1303
		2400				11	795	2400	2765	1402	1,33	74,03	13,75	-	1214	-	1396
11213	0868	1200	XXXX	YYYY	-0000	12	868	1200	1685	845	1,35	42,60	8,16	-	784	-	902
		1400				12	868	1400	1921	964	1,35	48,24	9,24	-	870	-	1001
		1600				12	868	1600	2152	1080	1,35	53,88	10,44	-	958	-	1102
		1800				12	868	1800	2376	1192	1,35	60,48	11,52	-	1045	-	1202
		2000				12	868	2000	2594	1302	1,35	67,08	12,60	-	1133	-	1303
		2200				12	868	2200	2808	1416	1,34	73,80	13,80	-	1221	-	1404
		2400				12	868	2400	3017	1529	1,33	80,76	15,00	-	1308	-	1504
11213	1013	1200	XXXX	YYYY	-0000	14	1013	1200	1966	986	1,35	49,70	9,52	-	891	-	1025
		1400				14	1013	1400	2241	1124	1,35	56,28	10,78	-	992	-	1141
		1600				14	1013	1600	2510	1259	1,35	62,86	12,18	-	1092	-	1256
		1800				14	1013	1800	2772	1391	1,35	70,56	13,44	-	1194	-	1373
		2000				14	1013	2000	3027	1519	1,35	78,26	14,70	-	1294	-	1488
		2200				14	1013	2200	3276	1652	1,34	86,10	16,10	-	1396	-	1605
		2400				14	1013	2400	3520	1784	1,33	94,22	17,50	-	1497	-	1722

CE<sub>05</sub> conform EN442-1: radiatoren en convectoren

Voor de warmteafgiftes van andere regimes, kijkt u op p. 308 (correctiefactoren)  
 Prijzen in euro (excl. BTW)

**HOE VIOLA VERTICAAL BESTELLEN**  
Leveringstermijn 15 - 30 werkdagen  
(zonder transportduur)

**VIOLA VERTICAAL (V2-ZB)**

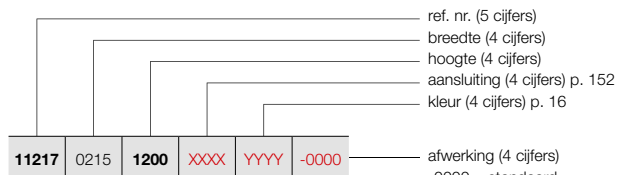

**VRIJSTAANDE OPSTELLING (V2-ZB)**

Zie p. 150 voor extra toebehoren.

- 0000 = standaard
- 0007 = telescopische voeten + muurbevestigingen
- 0008 = vrijstaand 1 voet
- 0009 = vrijstaand 2 voeten



V2-ZB

BESTELCODE MAATWERK VIOLA VERTICAAL	TECHNISCHE GEGEVENS									STANDAARDKLEUR		ANDERE KLEUREN					
	buizen	breedte (L mm)	hoogte (H mm)	75/65/20 (Watt)	55/45/20 (Watt)	n-exp.	gewicht (kg)	inhoud (l)	el. weerst. (Watt)	prijs RAL 9016	verkorte ref. nr. RAL 9016 voorraad	prijs kleur					
<b>REF. NR. VIOLA VERTICAAL V2-ZB : 11217</b>																	
<b>11217</b>	<b>0215</b>	<b>1200</b>	<b>XXXX</b>	<b>YYYY</b>	<b>-0000</b>	3	215	1200	445	226	1,33	13,56	3,78	-	<b>410</b>	-	<b>472</b>
		<b>1400</b>				3	215	1400	518	263	1,33	15,63	4,35	-	<b>447</b>	-	<b>514</b>
		<b>1600</b>				3	215	1600	586	296	1,34	17,70	4,92	-	<b>483</b>	-	<b>555</b>
		<b>1800</b>				3	215	1800	649	327	1,34	19,80	5,49	-	<b>520</b>	-	<b>598</b>
		<b>2000</b>				3	215	2000	705	356	1,34	21,87	6,06	-	<b>555</b>	-	<b>638</b>
		<b>2200</b>				3	215	2200	756	381	1,34	23,40	6,42	-	<b>592</b>	-	<b>681</b>
		<b>2400</b>				3	215	2400	801	404	1,34	24,39	6,60	-	<b>628</b>	-	<b>722</b>
<b>11217</b>	<b>0288</b>	<b>1200</b>	<b>XXXX</b>	<b>YYYY</b>	<b>-0000</b>	4	288	1200	593	301	1,33	18,08	5,04	-	<b>483</b>	-	<b>555</b>
		<b>1400</b>				4	288	1400	691	350	1,33	20,84	5,80	-	<b>528</b>	-	<b>607</b>
		<b>1600</b>				4	288	1600	782	394	1,34	23,60	6,56	-	<b>575</b>	-	<b>661</b>
		<b>1800</b>				4	288	1800	865	436	1,34	26,40	7,32	-	<b>620</b>	-	<b>713</b>
		<b>2000</b>				4	288	2000	940	474	1,34	29,16	8,08	-	<b>665</b>	-	<b>765</b>
		<b>2200</b>				4	288	2200	1008	508	1,34	31,20	8,56	-	<b>711</b>	-	<b>818</b>
		<b>2400</b>				4	288	2400	1068	539	1,34	32,52	8,80	-	<b>756</b>	-	<b>869</b>
<b>11217</b>	<b>0360</b>	<b>1200</b>	<b>XXXX</b>	<b>YYYY</b>	<b>-0000</b>	5	360	1200	741	376	1,33	22,60	6,30	-	<b>555</b>	-	<b>638</b>
		<b>1400</b>				5	360	1400	864	438	1,33	26,05	7,25	-	<b>611</b>	-	<b>703</b>
		<b>1600</b>				5	360	1600	977	493	1,34	29,50	8,20	-	<b>665</b>	-	<b>765</b>
		<b>1800</b>				5	360	1800	1081	545	1,34	33,00	9,15	-	<b>720</b>	-	<b>828</b>
		<b>2000</b>				5	360	2000	1176	593	1,34	36,45	10,10	-	<b>776</b>	-	<b>892</b>
		<b>2200</b>				5	360	2200	1260	635	1,34	39,00	10,70	-	<b>830</b>	-	<b>955</b>
		<b>2400</b>				5	360	2400	1335	673	1,34	40,65	11,00	-	<b>885</b>	-	<b>1018</b>
<b>11217</b>	<b>0433</b>	<b>1200</b>	<b>XXXX</b>	<b>YYYY</b>	<b>-0000</b>	6	433	1200	889	451	1,33	27,12	7,56	-	<b>628</b>	-	<b>722</b>
		<b>1400</b>				6	433	1400	1036	525	1,33	31,26	8,70	-	<b>692</b>	-	<b>796</b>
		<b>1600</b>				6	433	1600	1172	591	1,34	35,40	9,84	-	<b>756</b>	-	<b>869</b>
		<b>1800</b>				6	433	1800	1297	654	1,34	39,60	10,98	-	<b>821</b>	-	<b>944</b>
		<b>2000</b>				6	433	2000	1411	712	1,34	43,74	12,12	-	<b>885</b>	-	<b>1018</b>
		<b>2200</b>				6	433	2200	1512	763	1,34	46,80	12,84	-	<b>949</b>	-	<b>1091</b>
		<b>2400</b>				6	433	2400	1601	807	1,34	48,78	13,20	-	<b>1012</b>	-	<b>1164</b>
<b>11217</b>	<b>0505</b>	<b>1200</b>	<b>XXXX</b>	<b>YYYY</b>	<b>-0000</b>	7	505	1200	1037	526	1,33	31,64	8,82	-	<b>702</b>	-	<b>807</b>
		<b>1400</b>				7	505	1400	1209	613	1,33	36,47	10,15	-	<b>774</b>	-	<b>890</b>
		<b>1600</b>				7	505	1600	1368	690	1,34	41,30	11,48	-	<b>848</b>	-	<b>975</b>
		<b>1800</b>				7	505	1800	1513	763	1,34	46,20	12,81	-	<b>921</b>	-	<b>1059</b>
		<b>2000</b>				7	505	2000	1646	830	1,34	51,03	14,14	-	<b>995</b>	-	<b>1144</b>
		<b>2200</b>				7	505	2200	1764	890	1,34	54,60	14,98	-	<b>1066</b>	-	<b>1226</b>
		<b>2400</b>				7	505	2400	1868	942	1,34	56,91	15,40	-	<b>1140</b>	-	<b>1311</b>

CE 05 conform EN442-1: radiatoren en convectoren

Voor de warmteafgiftes van andere regimes, kijkt u op p. 308 (correctiefactoren)  
Prijzen in euro (excl. BTW)

# VIOLA VERTICAAL (V2-ZB)



V2-ZB

## HOE VIOLA VERTICAAL BESTELLEN

Leveringstermijn 15 - 30 werkdagen  
(zonder transportduur)

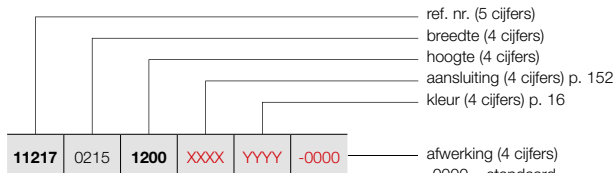

## VRIJSTAANDE OPSTELLING (V2-ZB)

Zie p. 150 voor extra toebehoren.

## HOE VOORRAADRADIATOR VIOLA VERTICAAL BESTELLEN

Leveringstermijn 5 werkdagen  
(zonder transportduur)

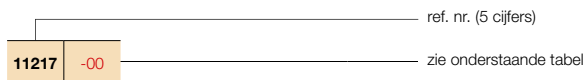

BESTELCODE MAATWERK VIOLA VERTICAAL	TECHNISCHE GEGEVENS									STANDAARDKLEUR		ANDERE KLEUREN				
	buizen	breedte (L mm)	hoogte (H mm)	75/65/20 (Watt)	55/45/20 (Watt)	n-exp.	gewicht (kg)	inhoud (l)	el. weerst. (Watt)	prijs RAL 9016	verkorte ref. nr. RAL 9016 voorraad	prijs kleur				
REF. NR. VIOLA VERTICAAL V2-ZB : 11217																
11217 0578	1200	XXXX	YYYY	-0000	8	578	1200	1186	601	1,33	36,16	10,08	-	774	-	890
	1400				8	578	1400	1382	701	1,33	41,68	11,60	-	856	-	984
	1600				8	578	1600	1563	788	1,34	47,20	13,12	-	938	-	1079
	1800				8	578	1800	1730	873	1,34	52,80	14,64	-	1021	11217-02	1174
	2000				8	578	2000	1881	949	1,34	58,32	16,16	-	1103	11217-03	1268
	2200				8	578	2200	2016	1017	1,34	62,40	17,12	-	1186	-	1364
	2400				8	578	2400	2135	1077	1,34	65,04	17,60	-	1268	-	1458
11217 0650	1200	XXXX	YYYY	-0000	9	650	1200	1334	676	1,33	40,68	11,34	-	848	-	975
	1400				9	650	1400	1554	788	1,33	46,89	13,05	-	938	-	1079
	1600				9	650	1600	1759	887	1,34	53,10	14,76	-	1030	-	1185
	1800				9	650	1800	1946	981	1,34	59,40	16,47	-	1121	-	1289
	2000				9	650	2000	2116	1067	1,34	65,61	18,18	-	1213	-	1395
	2200				9	650	2200	2268	1144	1,34	70,20	19,26	-	1305	-	1501
	2400				9	650	2400	2402	1211	1,34	73,17	19,80	-	1396	-	1605
11217 0723	1200	XXXX	YYYY	-0000	10	723	1200	1482	751	1,33	45,20	12,60	-	920	-	1058
	1400				10	723	1400	1727	875	1,33	52,10	14,50	-	1021	-	1174
	1600				10	723	1600	1954	985	1,34	59,00	16,40	-	1121	-	1289
	1800				10	723	1800	2162	1090	1,34	66,00	18,30	-	1223	-	1406
	2000				10	723	2000	2351	1186	1,34	72,90	20,20	-	1323	-	1521
	2200				10	723	2200	2520	1271	1,34	78,00	21,40	-	1423	-	1636
	2400				10	723	2400	2669	1346	1,34	81,30	22,00	-	1523	-	1751
11217 0795	1200	XXXX	YYYY	-0000	11	795	1200	1630	826	1,33	49,72	13,86	-	993	-	1142
	1400				11	795	1400	1900	963	1,33	57,31	15,95	-	1103	-	1268
	1600				11	795	1600	2149	1084	1,34	64,90	18,04	-	1211	-	1393
	1800				11	795	1800	2378	1199	1,34	72,60	20,13	-	1323	-	1521
	2000				11	795	2000	2586	1304	1,34	80,19	22,22	-	1433	-	1648
	2200				11	795	2200	2772	1398	1,34	85,80	23,54	-	1541	-	1772
	2400				11	795	2400	2936	1481	1,34	89,43	24,20	-	1651	-	1899
11217 0868	1200	XXXX	YYYY	-0000	12	868	1200	1778	901	1,33	54,24	15,12	-	1066	-	1226
	1400				12	868	1400	2072	1050	1,33	62,52	17,40	-	1183	-	1360
	1600				12	868	1600	2345	1183	1,34	70,80	19,68	-	1303	-	1498
	1800				12	868	1800	2594	1308	1,34	79,20	21,96	-	1421	-	1634
	2000				12	868	2000	2821	1423	1,34	87,48	24,24	-	1541	-	1772
	2200				12	868	2200	3024	1525	1,34	93,60	25,68	-	1660	-	1909
	2400				12	868	2400	3203	1615	1,34	97,56	26,40	-	1779	-	2046
11217 1013	1200	XXXX	YYYY	-0000	14	1013	1200	2075	1052	1,33	63,28	17,64	-	1211	-	1393
	1400				14	1013	1400	2418	1226	1,33	72,94	20,30	-	1348	-	1550
	1600				14	1013	1600	2736	1380	1,34	82,60	22,96	-	1485	-	1708
	1800				14	1013	1800	3027	1527	1,34	92,40	25,62	-	1623	-	1866
	2000				14	1013	2000	3291	1660	1,34	102,06	28,28	-	1760	-	2024
	2200				14	1013	2200	3528	1779	1,34	109,20	29,96	-	1898	-	2183
	2400				14	1013	2400	3737	1885	1,34	113,82	30,80	-	2034	-	2339

CE 05 conform EN442-1: radiatoren en convectoren

Voor de warmteafgiftes van andere regimes, kijkt u op p. 308 (correctiefactoren)  
Prijzen in euro (excl. BTW)

## VIOLA HORIZONTAAL (H1-RO, H1L1-RO, H2-RO, H2L1-RO, H2L2-RO)

### TYPES

- H1-RO enkele rij buizen, H2-RO dubbele rij buizen, H1L1-RO, H2L1-RO, H2L2-RO (1 of 2 rijen stalen lamellen)

### BUIZEN

- Horizontaal, platovaal 70 x 10 mm

### COLLECTOREN

- Verticaal, vierkant, achterliggend 34 x 34 mm

### KLEUREN

- Standaardkleur wit RAL 9016
- Niet verkrijgbaar in kleuren Gloss White en Jet Black
- Uitgebreide kleurenkaart zie p. 16

### SPECIAAL

- Bij types H1L1-RO / H2L1-RO en H2L2-RO zijn 1 of 2 rijen stalen lamellen ter verhoging van de warmteafgifte op de platovale buizen gepuntlast.
- Standaard met rooster. Indien gewenst zonder rooster ook mogelijk.

### BEVESTIGINGEN

- Muurbevestigingen standaard
- H2-RO / H2L1-RO ook verkrijgbaar als vrijstaande opstelling, zie p. 150.

### TECHNISCH

- Weerstandsgelast (onzichtbare lasnaden)
- KTL-grondlaag, poedercoating
- Standaardwerkdruk: 4 bar. Meerprijs hogere werkdruk (10 bar): +10%.
- De leveringstermijn van radiator met een hogere werkdruk is 1 week extra.
- Maximale bedrijfstemperatuur: 110°C

### ELEKTRISCH (zie hoofdstuk elektrische radiatoren)

- ✗ Zuiver elektrische radiator in de fabriek voorgevuld
- ✗ Gemengde radiator

### TECHNISCHE TEKENINGEN

- Zie p. 154

### AANSLUITING

- ✓ Eénpuntsaansluiting voor éénpijpssysteem (radiator speciaal te bestellen) (zie p. 301)
- ✓ Eénpuntsaansluiting voor tweepijpssysteem (radiator speciaal te bestellen) (zie p. 301)
- ✓ Tweepuntsaansluiting voor éénpijpssysteem (aansluiting via het geïntegreerd ventiel) (zie p. 302)
- ✓ Tweepuntsaansluiting voor tweepijpssysteem (standaard) (zie p. 300)
- ✓ Geïntegreerd ventiel (**meerprijs €102**) (radiator speciaal te bestellen) (zie p. 302)



VASCO

STAAL DESIGNRADIATOREN

### OVER VIOLA HORIZONTAAL

#### In het verlengde van een grote traditie

Ook de Viola Horizontaal combineert, net als de Viola Verticaal een sobere, uniforme look met een optimale warmteafgifte. De radiator is beschikbaar in enkele en dubbele uitvoering. Het design is sober en overal toepasbaar. Kan ook in een vrijstaande opstelling worden geïnstalleerd.

### AANBEVOLEN AANSLUITING GEÏNTEGREERD VENTIEL

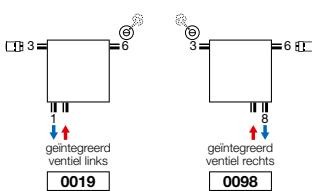

Andere aansluitmogelijkheden, zie p. 152

### AANBEVOLEN VOOR BADKAMER IN OPTIE



art. nr. 118230100000099  
prijs € 104

Koppelingen, zie p. 313



handdoekbeugel (chrom) art. nr. 118322300000099  
prijs € 166

Andere accessoires, zie p. 151



H2-RO / H2L1-RO



# VIOLA HORIZONTAAL (H1-RO)

## HOE VIOLA HORIZONTAAL BESTELLEN

Leveringstermijn 15 - 30 werkdagen  
(zonder transportduur)



H1-RO

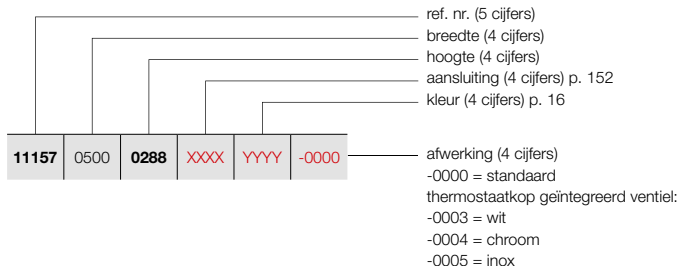

BESTELCODE MAATWERK VIOLA HORIZONTAAL						TECHNISCHE GEGEVENS							STANDAARDKLEUR	ANDERE KLEUREN							
						buizen	breedte (L mm)	hoogte (H mm)	75/65/20 (Watt)	55/45/20 (Watt)	n-exp.	gewicht (kg)	inhoud (l)	el. weerst. (Watt)	prijs RAL 9016	prijs kleur					
REF. NR. VIOLA HORIZONTAAL H1-RO : 11157																					
11157	0500	0288	XXXX	YYYY	-0000	4	500	288	167	88	1,25	3,89	1,11	-	180	207					
		0360				5	500	360	205	109	1,24	4,94	1,40	-	205	236					
		0433				6	500	433	243	129	1,24	6,04	1,73	-	229	263					
		0505				7	500	505	281	148	1,25	7,12	2,05	-	252	290					
		0578				8	500	578	320	169	1,25	8,22	2,38	-	277	319					
		0650				9	500	650	358	189	1,25	9,30	2,70	-	301	346					
		0723				10	500	723	398	210	1,25	10,31	2,99	-	325	374					
		0795				11	500	795	438	231	1,25	11,30	3,27	-	349	401					
		0868				12	500	868	480	253	1,25	12,30	3,55	-	373	429					
		11157				0600	0288	XXXX	YYYY	-0000	4	600	288	200	106	1,25	4,67	1,33	-	195	224
							0360				5	600	360	245	130	1,24	5,92	1,68	-	221	254
							0433				6	600	433	291	154	1,24	7,24	2,07	-	248	285
0505	7		600	505	337		178				1,25	8,54	2,46	-	275	316					
0578	8		600	578	383		202				1,25	9,86	2,85	-	302	347					
0650	9		600	650	430		227				1,25	11,16	3,24	-	330	380					
0723	10		600	723	478		252				1,25	12,37	3,58	-	356	409					
0795	11		600	795	526		278				1,25	13,55	3,92	-	383	440					
0868	12		600	868	575		304				1,25	14,76	4,26	-	410	472					
11157	0700		0288	XXXX	YYYY		-0000				4	700	288	234	124	1,25	5,45	1,55	-	210	242
			0360								5	700	360	286	152	1,24	6,91	1,96	-	239	275
			0433								6	700	433	340	180	1,24	8,45	2,42	-	269	309
		0505	7			700		505	393	208	1,25	9,96	2,87	-	298	343					
		0578	8			700		578	447	236	1,25	11,50	3,33	-	328	377					
		0650	9			700		650	501	265	1,25	13,02	3,78	-	357	411					
		0723	10			700		723	557	294	1,25	14,43	4,18	-	386	444					
		0795	11			700		795	613	324	1,25	15,81	4,57	-	416	478					
		0868	12			700		868	671	354	1,25	17,22	4,97	-	446	513					
		11157	0800			0288		XXXX	YYYY	-0000	4	800	288	267	141	1,25	6,22	1,78	-	225	259
						0360					5	800	360	327	174	1,24	7,90	2,24	-	256	294
						0433					6	800	433	388	206	1,24	9,66	2,76	-	288	331
0505	7			800	505	449	237				1,25	11,38	3,28	-	321	369					
0578	8			800	578	511	270				1,25	13,14	3,80	-	353	406					
0650	9			800	650	573	303				1,25	14,88	4,32	-	385	443					
0723	10			800	723	637	336				1,25	16,49	4,78	-	417	480					
0795	11			800	795	701	370				1,25	18,07	5,22	-	450	518					
0868	12			800	868	767	405				1,25	19,68	5,68	-	482	554					
11157	0900			0288	XXXX	YYYY	-0000				4	900	288	301	159	1,25	7,00	2,00	-	239	275
				0360							5	900	360	368	195	1,24	8,88	2,52	-	274	315
				0433							6	900	433	437	232	1,24	10,86	3,11	-	309	355
		0505	7	900				505	505	267	1,25	12,81	3,69	-	344	396					
		0578	8	900				578	575	304	1,25	14,79	4,28	-	378	435					
		0650	9	900				650	644	340	1,25	16,74	4,86	-	413	475					
		0723	10	900				723	716	378	1,25	18,55	5,37	-	448	515					
		0795	11	900				795	788	416	1,25	20,33	5,88	-	483	555					
		0868	12	900				868	863	456	1,25	22,14	6,39	-	518	596					

CE 05 conform EN442-1: radiatoren en convectoren

Voor de warmteafgifte van andere regimes, kijkt u op p. 308 (correctiefactoren)  
Prijzen in euro (excl. BTW)

## HOE VIOLA HORIZONTAAL BESTELLEN

Leveringstermijn 15 - 30 werkdagen  
(zonder transportduur)

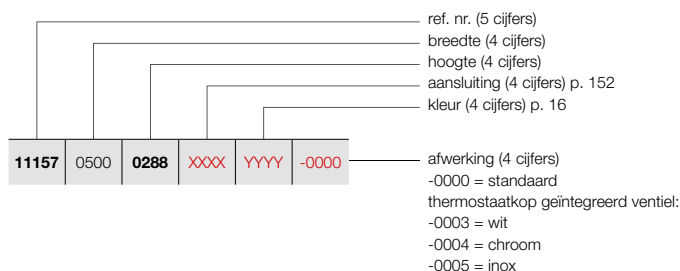

## VIOLA HORIZONTAAL (H1-RO)



H1-RO

BESTELCODE MAATWERK VIOLA HORIZONTAAL	TECHNISCHE GEGEVENS									STANDAARDKLEUR	ANDERE KLEUREN					
	buizen	breedte (L mm)	hoogte (H mm)	75/65/20 (Watt)	55/45/20 (Watt)	n-exp.	gewicht (kg)	inhoud (l)	el. weerst. (Watt)	prijs RAL 9016	prijs kleur					
<b>REF. NR. VIOLA HORIZONTAAL H1-RO : 11157</b>																
<b>11157</b>	<b>1000</b>	<b>0288</b>	<b>XXXX</b>	<b>YYYY</b>	<b>-0000</b>	4	1000	288	334	176	1,25	7,78	2,22	-	<b>253</b>	<b>291</b>
		<b>0360</b>				5	1000	360	409	217	1,24	9,87	2,80	-	<b>290</b>	<b>334</b>
		<b>0433</b>				6	1000	433	485	257	1,24	12,07	3,45	-	<b>329</b>	<b>378</b>
		<b>0505</b>				7	1000	505	561	296	1,25	14,23	4,10	-	<b>367</b>	<b>422</b>
		<b>0578</b>				8	1000	578	639	337	1,25	16,43	4,75	-	<b>404</b>	<b>465</b>
		<b>0650</b>				9	1000	650	716	378	1,25	18,60	5,40	-	<b>442</b>	<b>508</b>
		<b>0723</b>				10	1000	723	796	420	1,25	20,61	5,97	-	<b>479</b>	<b>551</b>
		<b>0795</b>				11	1000	795	876	463	1,25	22,59	6,53	-	<b>517</b>	<b>595</b>
		<b>0868</b>				12	1000	868	959	506	1,25	24,60	7,10	-	<b>554</b>	<b>637</b>
<b>11157</b>	<b>1100</b>	<b>0288</b>	<b>XXXX</b>	<b>YYYY</b>	<b>-0000</b>	4	1100	288	367	194	1,25	8,56	2,44	-	<b>268</b>	<b>308</b>
		<b>0360</b>				5	1100	360	450	239	1,24	10,86	3,08	-	<b>308</b>	<b>354</b>
		<b>0433</b>				6	1100	433	534	283	1,24	13,28	3,80	-	<b>348</b>	<b>400</b>
		<b>0505</b>				7	1100	505	617	326	1,25	15,65	4,51	-	<b>389</b>	<b>447</b>
		<b>0578</b>				8	1100	578	703	371	1,25	18,07	5,23	-	<b>430</b>	<b>495</b>
		<b>0650</b>				9	1100	650	788	416	1,25	20,46	5,94	-	<b>470</b>	<b>541</b>
		<b>0723</b>				10	1100	723	876	463	1,25	22,67	6,57	-	<b>510</b>	<b>587</b>
		<b>0795</b>				11	1100	795	964	509	1,25	24,85	7,18	-	<b>550</b>	<b>633</b>
		<b>0868</b>				12	1100	868	1055	557	1,25	27,06	7,81	-	<b>590</b>	<b>679</b>
<b>11157</b>	<b>1200</b>	<b>0288</b>	<b>XXXX</b>	<b>YYYY</b>	<b>-0000</b>	4	1200	288	401	212	1,25	9,34	2,66	-	<b>282</b>	<b>324</b>
		<b>0360</b>				5	1200	360	491	261	1,24	11,84	3,36	-	<b>325</b>	<b>374</b>
		<b>0433</b>				6	1200	433	582	309	1,24	14,48	4,14	-	<b>369</b>	<b>424</b>
		<b>0505</b>				7	1200	505	673	355	1,25	17,08	4,92	-	<b>412</b>	<b>474</b>
		<b>0578</b>				8	1200	578	767	405	1,25	19,72	5,70	-	<b>454</b>	<b>522</b>
		<b>0650</b>				9	1200	650	859	454	1,25	22,32	6,48	-	<b>497</b>	<b>572</b>
		<b>0723</b>				10	1200	723	955	504	1,25	24,73	7,16	-	<b>541</b>	<b>622</b>
		<b>0795</b>				11	1200	795	1051	555	1,25	27,11	7,84	-	<b>584</b>	<b>672</b>
		<b>0868</b>				12	1200	868	1151	608	1,25	29,52	8,52	-	<b>627</b>	<b>721</b>
<b>11157</b>	<b>1400</b>	<b>0288</b>	<b>XXXX</b>	<b>YYYY</b>	<b>-0000</b>	4	1400	288	468	247	1,25	10,89	3,11	-	<b>311</b>	<b>358</b>
		<b>0360</b>				5	1400	360	573	304	1,24	13,82	3,92	-	<b>361</b>	<b>415</b>
		<b>0433</b>				6	1400	433	679	360	1,24	16,90	4,83	-	<b>409</b>	<b>470</b>
		<b>0505</b>				7	1400	505	785	415	1,25	19,92	5,74	-	<b>457</b>	<b>526</b>
		<b>0578</b>				8	1400	578	895	473	1,25	23,00	6,65	-	<b>506</b>	<b>582</b>
		<b>0650</b>				9	1400	650	1002	529	1,25	26,04	7,56	-	<b>554</b>	<b>637</b>
		<b>0723</b>				10	1400	723	1114	588	1,25	28,85	8,36	-	<b>603</b>	<b>693</b>
		<b>0795</b>				11	1400	795	1226	647	1,25	31,63	9,14	-	<b>651</b>	<b>749</b>
		<b>0868</b>				12	1400	868	1343	709	1,25	34,44	9,94	-	<b>699</b>	<b>804</b>
<b>11157</b>	<b>1600</b>	<b>0288</b>	<b>XXXX</b>	<b>YYYY</b>	<b>-0000</b>	4	1600	288	534	282	1,25	12,45	3,55	-	<b>341</b>	<b>392</b>
		<b>0360</b>				5	1600	360	654	347	1,24	15,79	4,48	-	<b>394</b>	<b>453</b>
		<b>0433</b>				6	1600	433	776	412	1,24	19,31	5,52	-	<b>448</b>	<b>515</b>
		<b>0505</b>				7	1600	505	898	474	1,25	22,77	6,56	-	<b>503</b>	<b>578</b>
		<b>0578</b>				8	1600	578	1022	540	1,25	26,29	7,60	-	<b>556</b>	<b>639</b>
		<b>0650</b>				9	1600	650	1146	605	1,25	29,76	8,64	-	<b>610</b>	<b>702</b>
		<b>0723</b>				10	1600	723	1274	673	1,25	32,98	9,55	-	<b>664</b>	<b>764</b>
		<b>0795</b>				11	1600	795	1402	740	1,25	36,14	10,45	-	<b>718</b>	<b>826</b>
		<b>0868</b>				12	1600	868	1534	810	1,25	39,36	11,36	-	<b>771</b>	<b>887</b>

# VIOLA HORIZONTAAL (H1-RO)

## HOE VIOLA HORIZONTAAL BESTELLEN

Leveringstermijn 15 - 30 werkdagen  
(zonder transportduur)



H1-RO

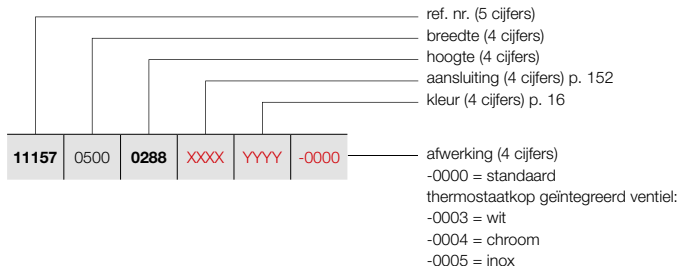

BESTELCODE MAATWERK VIOLA HORIZONTAAL						TECHNISCHE GEGEVENS							STANDAARDKLEUR	ANDERE KLEUREN							
						buizen	breedte (L mm)	hoogte (H mm)	75/65/20 (Watt)	55/45/20 (Watt)	n-exp.	gewicht (kg)	inhoud (l)	el. weerst. (Watt)	prijs RAL 9016	prijs kleur					
REF. NR. VIOLA HORIZONTAAL H1-RO : 11157																					
11157	1800	0288	XXXX	YYYY	-0000	4	1800	288	601	317	1,25	14,00	4,00	-	370	426					
		0360				5	1800	360	736	391	1,24	17,77	5,04	-	430	495					
		0433				6	1800	433	873	463	1,24	21,73	6,21	-	488	561					
		0505				7	1800	505	1010	533	1,25	25,61	7,38	-	548	630					
		0578				8	1800	578	1150	607	1,25	29,57	8,55	-	607	698					
		0650				9	1800	650	1289	681	1,25	33,48	9,72	-	666	766					
		0723				10	1800	723	1433	757	1,25	37,10	10,75	-	725	834					
		0795				11	1800	795	1577	833	1,25	40,66	11,75	-	785	903					
		0868				12	1800	868	1726	911	1,25	44,28	12,78	-	845	972					
		11157				2000	0288	XXXX	YYYY	-0000	4	2000	288	668	353	1,25	15,56	4,44	-	399	459
							0360				5	2000	360	818	434	1,24	19,74	5,60	-	464	534
							0433				6	2000	433	970	515	1,24	24,14	6,90	-	528	607
0505	7		2000	505	1122		592				1,25	28,46	8,20	-	593	682					
0578	8		2000	578	1278		675				1,25	32,86	9,50	-	658	757					
0650	9		2000	650	1432		756				1,25	37,20	10,80	-	722	830					
0723	10		2000	723	1592		841				1,25	41,22	11,94	-	787	905					
0795	11		2000	795	1752		925				1,25	45,18	13,06	-	852	980					
0868	12		2000	868	1918		1013				1,25	49,20	14,20	-	917	1055					
11157	2200		0288	XXXX	YYYY		-0000				4	2200	288	735	388	1,25	17,12	4,88	-	428	492
			0360								5	2200	360	900	478	1,24	21,71	6,16	-	499	574
			0433								6	2200	433	1067	566	1,24	26,55	7,59	-	569	654
		0505	7			2200		505	1234	652	1,25	31,31	9,02	-	639	735					
		0578	8			2200		578	1406	742	1,25	36,15	10,45	-	709	815					
		0650	9			2200		650	1575	832	1,25	40,92	11,88	-	779	896					
		0723	10			2200		723	1751	925	1,25	45,34	13,13	-	849	976					
		0795	11			2200		795	1927	1018	1,25	49,70	14,37	-	919	1057					
		0868	12			2200		868	2110	1114	1,25	54,12	15,62	-	989	1137					
		11157	2400			0288		XXXX	YYYY	-0000	4	2400	288	802	424	1,25	18,67	5,33	-	457	526
						0360					5	2400	360	982	521	1,24	23,69	6,72	-	533	613
						0433					6	2400	433	1164	618	1,24	28,97	8,28	-	609	700
0505	7			2400	505	1346	711				1,25	34,15	9,84	-	684	787					
0578	8			2400	578	1534	810				1,25	39,43	11,40	-	759	873					
0650	9			2400	650	1718	907				1,25	44,64	12,96	-	835	960					
0723	10			2400	723	1910	1009				1,25	49,46	14,33	-	911	1048					
0795	11			2400	795	2102	1110				1,25	54,22	15,67	-	986	1134					
0868	12			2400	868	2302	1216				1,25	59,04	17,04	-	1062	1221					
11157	2600			0288	XXXX	YYYY	-0000				4	2600	288	868	458	1,25	20,23	5,77	-	486	559
				0360							5	2600	360	1063	564	1,24	25,66	7,28	-	568	653
				0433							6	2600	433	1261	669	1,24	31,38	8,97	-	648	745
		0505	7	2600				505	1459	770	1,25	37,00	10,66	-	729	838					
		0578	8	2600				578	1661	877	1,25	42,72	12,35	-	811	933					
		0650	9	2600				650	1862	983	1,25	48,36	14,04	-	891	1025					
		0723	10	2600				723	2070	1093	1,25	53,59	15,52	-	972	1118					
		0795	11	2600				795	2278	1203	1,25	58,73	16,98	-	1053	1211					
		0868	12	2600				868	2493	1316	1,25	63,96	18,46	-	1134	1304					

CE 05 conform EN442-1: radiatoren en convectoren

Voor de warmteafgifte van andere regimes, kijkt u op p. 308 (correctiefactoren)  
 Prijzen in euro (excl. BTW)

## HOE VIOLA HORIZONTAAL BESTELLEN

Leveringstermijn 15 - 30 werkdagen  
(zonder transportduur)

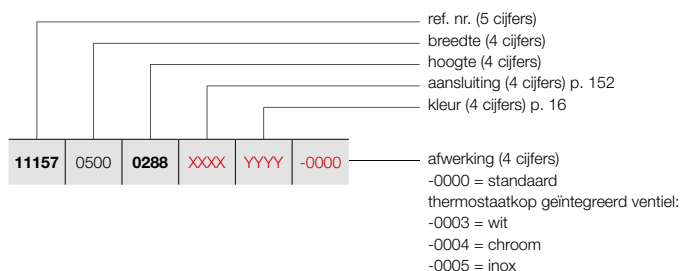

## VIOLA HORIZONTAAL (H1-RO)



H1-RO

BESTELCODE MAATWERK VIOLA HORIZONTAAL	TECHNISCHE GEGEVENS									STANDAARDKLEUR	ANDERE KLEUREN					
	buizen	breedte (L mm)	hoogte (H mm)	75/65/20 (Watt)	55/45/20 (Watt)	n-exp.	gewicht (kg)	inhoud (l)	el. weerst. (Watt)	prijs RAL 9016	prijs kleur					
<b>REF. NR. VIOLA HORIZONTAAL H1-RO : 11157</b>																
<b>11157</b>	<b>2800</b>	<b>0288</b>	<b>XXXX</b>	<b>YYYY</b>	<b>-0000</b>	4	2800	288	935	494	1,25	21,78	6,22	-	<b>515</b>	<b>592</b>
		<b>0360</b>				5	2800	360	1145	608	1,24	27,64	7,84	-	<b>602</b>	<b>692</b>
		<b>0433</b>				6	2800	433	1358	721	1,24	33,80	9,66	-	<b>688</b>	<b>791</b>
		<b>0505</b>				7	2800	505	1571	830	1,25	39,84	11,48	-	<b>775</b>	<b>891</b>
		<b>0578</b>				8	2800	578	1789	945	1,25	46,00	13,30	-	<b>861</b>	<b>990</b>
		<b>0650</b>				9	2800	650	2005	1059	1,25	52,08	15,12	-	<b>948</b>	<b>1090</b>
		<b>0723</b>				10	2800	723	2229	1177	1,25	57,71	16,72	-	<b>1034</b>	<b>1189</b>
		<b>0795</b>				11	2800	795	2453	1295	1,25	63,25	18,28	-	<b>1120</b>	<b>1288</b>
		<b>0868</b>				12	2800	868	2685	1418	1,25	68,88	19,88	-	<b>1206</b>	<b>1387</b>
<b>11157</b>	<b>3000</b>	<b>0288</b>	<b>XXXX</b>	<b>YYYY</b>	<b>-0000</b>	4	3000	288	1002	529	1,25	23,34	6,66	-	<b>545</b>	<b>627</b>
		<b>0360</b>				5	3000	360	1227	651	1,24	29,61	8,40	-	<b>637</b>	<b>733</b>
		<b>0433</b>				6	3000	433	1455	772	1,24	36,21	10,35	-	<b>728</b>	<b>837</b>
		<b>0505</b>				7	3000	505	1683	889	1,25	42,69	12,30	-	<b>820</b>	<b>943</b>
		<b>0578</b>				8	3000	578	1917	1012	1,25	49,29	14,25	-	<b>912</b>	<b>1049</b>
		<b>0650</b>				9	3000	650	2148	1134	1,25	55,80	16,20	-	<b>1003</b>	<b>1153</b>
		<b>0723</b>				10	3000	723	2388	1261	1,25	61,83	17,91	-	<b>1095</b>	<b>1259</b>
		<b>0795</b>				11	3000	795	2628	1388	1,25	67,77	19,59	-	<b>1187</b>	<b>1365</b>
		<b>0868</b>				12	3000	868	2877	1519	1,25	73,80	21,30	-	<b>1279</b>	<b>1471</b>

CE 05 conform EN442-1: radiatoren en convectoren

Voor de warmteafgiftes van andere regimes, kijkt u op p. 308 (correctiefactoren)  
Prijzen in euro (excl. BTW)

# VIOLA HORIZONTAAL (H1L1-RO)

## HOE VIOLA HORIZONTAAL BESTELLEN

Leveringstermijn 15 - 30 werkdagen  
(zonder transportduur)



H1L1-RO

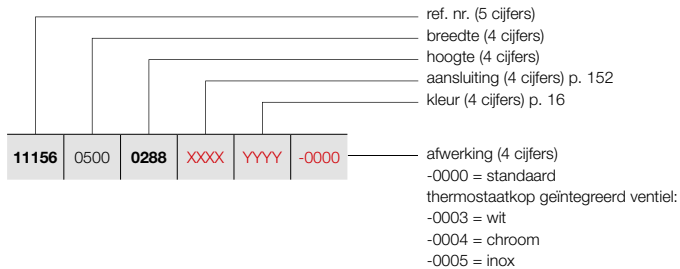

BESTELCODE MAATWERK VIOLA HORIZONTAAL						TECHNISCHE GEGEVENS						STANDAARDKLEUR	ANDERE KLEUREN								
buizen	breedte (L mm)	hoogte (H mm)	75/65/20 (Watt)	55/45/20 (Watt)	n-exp.	gewicht (kg)	inhoud (l)	el. weerst. (Watt)	prijs RAL 9016	prijs kleur											
REF. NR. VIOLA HORIZONTAAL H1L1-RO : 11156																					
11156	0500	0288	XXXX	YYYY	-0000	4	500	288	272	143	1,26	5,51	1,19	-	207	238					
		0360				5	500	360	322	168	1,27	7,00	1,50	-	239	275					
		0433				6	500	433	370	193	1,27	8,32	1,80	-	270	311					
		0505				7	500	505	415	216	1,28	9,63	2,10	-	302	347					
		0578				8	500	578	459	237	1,29	10,95	2,40	-	334	384					
		0650				9	500	650	501	259	1,29	12,25	2,70	-	365	420					
		0723				10	500	723	541	278	1,30	13,61	2,99	-	397	457					
		0795				11	500	795	580	299	1,30	14,95	3,27	-	428	492					
		0868				12	500	868	618	316	1,31	16,30	3,55	-	459	528					
		11156				0600	0288	XXXX	YYYY	-0000	4	600	288	326	171	1,26	6,61	1,42	-	227	261
							0360				5	600	360	386	202	1,27	8,40	1,80	-	263	302
							0433				6	600	433	444	232	1,27	9,98	2,16	-	299	344
0505	7		600	505	498		259				1,28	11,55	2,52	-	334	384					
0578	8		600	578	551		285				1,29	13,13	2,88	-	370	426					
0650	9		600	650	601		311				1,29	14,70	3,24	-	406	467					
0723	10		600	723	649		334				1,30	16,33	3,58	-	442	508					
0795	11		600	795	695		358				1,30	17,93	3,92	-	477	549					
0868	12		600	868	741		379				1,31	19,56	4,26	-	513	590					
11156	0700		0288	XXXX	YYYY		-0000				4	700	288	381	200	1,26	7,71	1,66	-	247	284
			0360								5	700	360	451	236	1,27	9,80	2,10	-	287	330
			0433								6	700	433	518	271	1,27	11,65	2,52	-	327	376
		0505	7			700		505	581	302	1,28	13,48	2,94	-	367	422					
		0578	8			700		578	643	333	1,29	15,32	3,36	-	407	468					
		0650	9			700		650	701	363	1,29	17,15	3,78	-	446	513					
		0723	10			700		723	757	390	1,30	19,05	4,18	-	486	559					
		0795	11			700		795	811	417	1,30	20,92	4,57	-	526	605					
		0868	12			700		868	865	443	1,31	22,82	4,97	-	565	650					
		11156	0800			0288		XXXX	YYYY	-0000	4	800	288	435	229	1,26	8,82	1,90	-	268	308
						0360					5	800	360	515	269	1,27	11,20	2,40	-	311	358
						0433					6	800	433	592	309	1,27	13,31	2,88	-	355	408
0505	7			800	505	664	345				1,28	15,40	3,36	-	400	460					
0578	8			800	578	734	380				1,29	17,51	3,84	-	443	509					
0650	9			800	650	801	414				1,29	19,60	4,32	-	487	560					
0723	10			800	723	866	446				1,30	21,77	4,78	-	531	611					
0795	11			800	795	927	477				1,30	23,91	5,22	-	575	661					
0868	12			800	868	988	506				1,31	26,08	5,68	-	619	712					
11156	0900			0288	XXXX	YYYY	-0000				4	900	288	490	257	1,26	9,92	2,13	-	287	330
				0360							5	900	360	580	303	1,27	12,60	2,70	-	336	386
				0433							6	900	433	666	348	1,27	14,98	3,24	-	384	442
		0505	7	900				505	747	388	1,28	17,33	3,78	-	432	497					
		0578	8	900				578	826	427	1,29	19,70	4,32	-	480	552					
		0650	9	900				650	901	466	1,29	22,05	4,86	-	528	607					
		0723	10	900				723	974	501	1,30	24,49	5,37	-	576	662					
		0795	11	900				795	1043	537	1,30	26,90	5,88	-	624	718					
		0868	12	900				868	1112	569	1,31	29,34	6,39	-	673	774					

CE 05 conform EN442-1: radiatoren en convectoren

Voor de warmteafgiftes van andere regimes, kijkt u op p. 308 (correctiefactoren)  
 Prijzen in euro (excl. BTW)

## HOE VIOLA HORIZONTAAL BESTELLEN

Leveringstermijn 15 - 30 werkdagen  
(zonder transportduur)

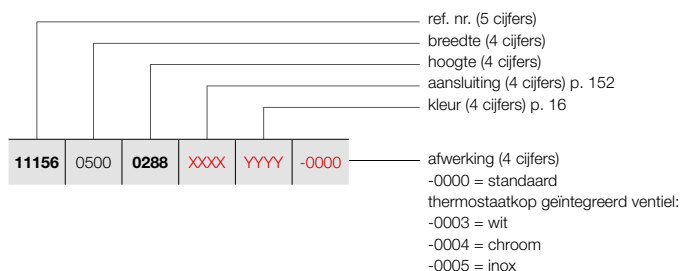

## VIOLA HORIZONTAAL (H1L1-RO)



H1L1-RO

BESTELCODE MAATWERK VIOLA HORIZONTAAL	TECHNISCHE GEGEVENS									STANDAARDKLEUR	ANDERE KLEUREN										
	buizen	breedte (L mm)	hoogte (H mm)	75/65/20 (Watt)	55/45/20 (Watt)	n-exp.	gewicht (kg)	inhoud (l)	el. weerst. (Watt)	prijs RAL 9016	prijs kleur										
<b>REF. NR. VIOLA HORIZONTAAL H1L1-RO : 11156</b>																					
11156	1000	0288	XXXX	YYYY	-0000	4	1000	288	544	286	1,26	11,02	2,37	-	308	354					
		0360				5	1000	360	644	337	1,27	14,00	3,00	-	361	415					
		0433				6	1000	433	740	387	1,27	16,64	3,60	-	412	474					
		0505				7	1000	505	830	432	1,28	19,25	4,20	-	465	535					
		0578				8	1000	578	918	475	1,29	21,89	4,80	-	517	595					
		0650				9	1000	650	1001	518	1,29	24,50	5,40	-	569	654					
		0723				10	1000	723	1082	557	1,30	27,21	5,97	-	621	714					
		0795				11	1000	795	1159	597	1,30	29,89	6,53	-	673	774					
		0868				12	1000	868	1235	632	1,31	32,60	7,10	-	725	834					
		11156				1100	0288	XXXX	YYYY	-0000	4	1100	288	598	314	1,26	12,12	2,61	-	328	377
							0360				5	1100	360	708	370	1,27	15,40	3,30	-	384	442
							0433				6	1100	433	814	425	1,27	18,30	3,96	-	441	507
0505	7		1100	505	913		475				1,28	21,18	4,62	-	496	570					
0578	8		1100	578	1010		523				1,29	24,08	5,28	-	553	636					
0650	9		1100	650	1101		570				1,29	26,95	5,94	-	610	702					
0723	10		1100	723	1190		613				1,30	29,93	6,57	-	665	765					
0795	11		1100	795	1275		656				1,30	32,88	7,18	-	722	830					
0868	12		1100	868	1359		696				1,31	35,86	7,81	-	779	896					
11156	1200		0288	XXXX	YYYY		-0000				4	1200	288	653	343	1,26	13,22	2,84	-	348	400
			0360								5	1200	360	773	404	1,27	16,80	3,60	-	409	470
			0433								6	1200	433	888	464	1,27	19,97	4,32	-	469	539
		0505	7			1200		505	996	518	1,28	23,10	5,04	-	529	608					
		0578	8			1200		578	1102	570	1,29	26,27	5,76	-	590	679					
		0650	9			1200		650	1201	621	1,29	29,40	6,48	-	650	748					
		0723	10			1200		723	1298	668	1,30	32,65	7,16	-	711	818					
		0795	11			1200		795	1391	716	1,30	35,87	7,84	-	771	887					
		0868	12			1200		868	1482	759	1,31	39,12	8,52	-	831	956					
		11156	1400			0288		XXXX	YYYY	-0000	4	1400	288	762	400	1,26	15,43	3,32	-	388	446
						0360					5	1400	360	902	471	1,27	19,60	4,20	-	457	526
						0433					6	1400	433	1036	542	1,27	23,30	5,04	-	526	605
0505	7			1400	505	1162	604				1,28	26,95	5,88	-	594	683					
0578	8			1400	578	1285	665				1,29	30,65	6,72	-	663	762					
0650	9			1400	650	1401	725				1,29	34,30	7,56	-	731	841					
0723	10			1400	723	1515	780				1,30	38,09	8,36	-	800	920					
0795	11			1400	795	1623	835				1,30	41,85	9,14	-	869	999					
0868	12			1400	868	1729	885				1,31	45,64	9,94	-	937	1078					
11156	1600			0288	XXXX	YYYY	-0000				4	1600	288	870	457	1,26	17,63	3,79	-	430	495
				0360							5	1600	360	1030	538	1,27	22,40	4,80	-	506	582
				0433							6	1600	433	1184	619	1,27	26,62	5,76	-	583	670
		0505	7	1600				505	1328	691	1,28	30,80	6,72	-	659	758					
		0578	8	1600				578	1469	760	1,29	35,02	7,68	-	736	846					
		0650	9	1600				650	1602	829	1,29	39,20	8,64	-	814	936					
		0723	10	1600				723	1731	891	1,30	43,54	9,55	-	890	1024					
		0795	11	1600				795	1854	954	1,30	47,82	10,45	-	967	1112					
		0868	12	1600				868	1976	1012	1,31	52,16	11,36	-	1044	1201					

CE 05 conform EN442-1: radiatoren en convectoren

Voor de warmteafgiftes van andere regimes, kijkt u op p. 308 (correctiefactoren)  
Prijzen in euro (excl. BTW)

# VIOLA HORIZONTAAL (H1L1-RO)

## HOE VIOLA HORIZONTAAL BESTELLEN

Leveringstermijn 15 - 30 werkdagen  
(zonder transportduur)



H1L1-RO

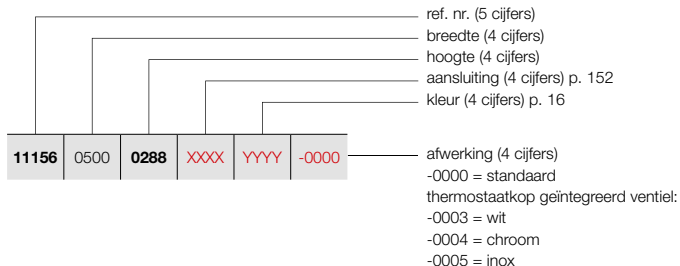

BESTELCODE MAATWERK VIOLA HORIZONTAAL							TECHNISCHE GEGEVENS					STANDAARDKLEUR	ANDERE KLEUREN								
buizen	breedte (L mm)	hoogte (H mm)	75/65/20 (Watt)	55/45/20 (Watt)	n-exp.	gewicht (kg)	inhoud (l)	el. weerst. (Watt)	prijs RAL 9016	prijs kleur											
REF. NR. VIOLA HORIZONTAAL H1L1-RO : 11156																					
11156	1800	0288	XXXX	YYYY	-0000	4	1800	288	979	514	1,26	19,84	4,27	-	470	541					
		0360				5	1800	360	1159	606	1,27	25,20	5,40	-	554	637					
		0433				6	1800	433	1332	696	1,27	29,95	6,48	-	640	736					
		0505				7	1800	505	1494	777	1,28	34,65	7,56	-	725	834					
		0578				8	1800	578	1652	855	1,29	39,40	8,64	-	810	932					
		0650				9	1800	650	1802	932	1,29	44,10	9,72	-	895	1029					
		0723				10	1800	723	1948	1003	1,30	48,98	10,75	-	980	1127					
		0795				11	1800	795	2086	1074	1,30	53,80	11,75	-	1065	1225					
		0868				12	1800	868	2223	1138	1,31	58,68	12,78	-	1151	1324					
		11156				2000	0288	XXXX	YYYY	-0000	4	2000	288	1088	572	1,26	22,04	4,74	-	510	587
							0360				5	2000	360	1288	673	1,27	28,00	6,00	-	604	695
							0433				6	2000	433	1480	774	1,27	33,28	7,20	-	696	800
0505	7		2000	505	1660		863				1,28	38,50	8,40	-	790	909					
0578	8		2000	578	1836		950				1,29	43,78	9,60	-	883	1015					
0650	9		2000	650	2002		1036				1,29	49,00	10,80	-	976	1122					
0723	10		2000	723	2164		1114				1,30	54,42	11,94	-	1070	1231					
0795	11		2000	795	2318		1193				1,30	59,78	13,06	-	1163	1337					
0868	12		2000	868	2470		1265				1,31	65,20	14,20	-	1257	1446					
11156	2200		0288	XXXX	YYYY		-0000				4	2200	288	1197	629	1,26	24,24	5,21	-	550	633
			0360								5	2200	360	1417	741	1,27	30,80	6,60	-	652	750
			0433								6	2200	433	1628	851	1,27	36,61	7,92	-	753	866
		0505	7			2200		505	1826	950	1,28	42,35	9,24	-	855	983					
		0578	8			2200		578	2020	1045	1,29	48,16	10,56	-	957	1101					
		0650	9			2200		650	2202	1139	1,29	53,90	11,88	-	1058	1217					
		0723	10			2200		723	2380	1225	1,30	59,86	13,13	-	1160	1334					
		0795	11			2200		795	2550	1313	1,30	65,76	14,37	-	1261	1450					
		0868	12			2200		868	2717	1391	1,31	71,72	15,62	-	1363	1567					
		11156	2400			0288		XXXX	YYYY	-0000	4	2400	288	1306	686	1,26	26,45	5,69	-	590	679
						0360					5	2400	360	1546	808	1,27	33,60	7,20	-	700	805
						0433					6	2400	433	1776	928	1,27	39,94	8,64	-	811	933
0505	7			2400	505	1992	1036				1,28	46,20	10,08	-	920	1058					
0578	8			2400	578	2203	1140				1,29	52,54	11,52	-	1030	1185					
0650	9			2400	650	2402	1243				1,29	58,80	12,96	-	1139	1310					
0723	10			2400	723	2597	1337				1,30	65,30	14,33	-	1249	1436					
0795	11			2400	795	2782	1432				1,30	71,74	15,67	-	1359	1563					
0868	12			2400	868	2964	1518				1,31	78,24	17,04	-	1469	1689					
11156	2600			0288	XXXX	YYYY	-0000				4	2600	288	1414	743	1,26	28,65	6,16	-	631	726
				0360							5	2600	360	1674	875	1,27	36,40	7,80	-	749	861
				0433							6	2600	433	1924	1006	1,27	43,26	9,36	-	867	997
		0505	7	2600				505	2158	1122	1,28	50,05	10,92	-	985	1133					
		0578	8	2600				578	2387	1235	1,29	56,91	12,48	-	1103	1268					
		0650	9	2600				650	2603	1347	1,29	63,70	14,04	-	1221	1404					
		0723	10	2600				723	2813	1448	1,30	70,75	15,52	-	1339	1540					
		0795	11	2600				795	3013	1551	1,30	77,71	16,98	-	1457	1676					
		0868	12	2600				868	3211	1644	1,31	84,76	18,46	-	1575	1811					

CE 05 conform EN442-1: radiatoren en convectoren

Voor de warmteafgiftes van andere regimes, kijkt u op p. 308 (correctiefactoren)  
Prijzen in euro (excl. BTW)

## HOE VIOLA HORIZONTAAL BESTELLEN

Leveringstermijn 15 - 30 werkdagen  
(zonder transportduur)

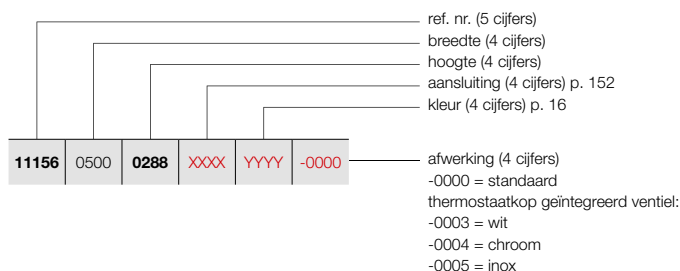

H1L1-RO

BESTELCODE MAATWERK VIOLA HORIZONTAAL	TECHNISCHE GEGEVENS									STANDAARDKLEUR	ANDERE KLEUREN					
	buizen	breedte (L mm)	hoogte (H mm)	75/65/20 (Watt)	55/45/20 (Watt)	n-exp.	gewicht (kg)	inhoud (l)	el. weerst. (Watt)	prijs RAL 9016	prijs kleur					
<b>REF. NR. VIOLA HORIZONTAAL H1L1-RO : 11156</b>																
<b>11156</b>	<b>2800</b>	<b>0288</b>	<b>XXXX</b>	<b>YYYY</b>	<b>-0000</b>	4	2800	288	1523	800	1,26	30,86	6,64	-	<b>672</b>	<b>773</b>
		<b>0360</b>				5	2800	360	1803	942	1,27	39,20	8,40	-	<b>797</b>	<b>917</b>
		<b>0433</b>				6	2800	433	2072	1083	1,27	46,59	10,08	-	<b>924</b>	<b>1063</b>
		<b>0505</b>				7	2800	505	2324	1209	1,28	53,90	11,76	-	<b>1050</b>	<b>1208</b>
		<b>0578</b>				8	2800	578	2570	1330	1,29	61,29	13,44	-	<b>1176</b>	<b>1352</b>
		<b>0650</b>				9	2800	650	2803	1450	1,29	68,60	15,12	-	<b>1303</b>	<b>1498</b>
		<b>0723</b>				10	2800	723	3030	1560	1,30	76,19	16,72	-	<b>1429</b>	<b>1643</b>
		<b>0795</b>				11	2800	795	3245	1670	1,30	83,69	18,28	-	<b>1555</b>	<b>1788</b>
		<b>0868</b>				12	2800	868	3458	1771	1,31	91,28	19,88	-	<b>1681</b>	<b>1933</b>
<b>11156</b>	<b>3000</b>	<b>0288</b>	<b>XXXX</b>	<b>YYYY</b>	<b>-0000</b>	4	3000	288	1632	857	1,26	33,06	7,11	-	<b>712</b>	<b>819</b>
		<b>0360</b>				5	3000	360	1932	1010	1,27	42,00	9,00	-	<b>847</b>	<b>974</b>
		<b>0433</b>				6	3000	433	2220	1160	1,27	49,92	10,80	-	<b>981</b>	<b>1128</b>
		<b>0505</b>				7	3000	505	2490	1295	1,28	57,75	12,60	-	<b>1115</b>	<b>1282</b>
		<b>0578</b>				8	3000	578	2754	1425	1,29	65,67	14,40	-	<b>1249</b>	<b>1436</b>
		<b>0650</b>				9	3000	650	3003	1554	1,29	73,50	16,20	-	<b>1384</b>	<b>1592</b>
		<b>0723</b>				10	3000	723	3246	1671	1,30	81,63	17,91	-	<b>1518</b>	<b>1746</b>
		<b>0795</b>				11	3000	795	3477	1790	1,30	89,67	19,59	-	<b>1653</b>	<b>1901</b>
		<b>0868</b>				12	3000	868	3705	1897	1,31	97,80	21,30	-	<b>1787</b>	<b>2055</b>

CE 05 conform EN442-1: radiatoren en convectoren

Voor de warmteafgiftes van andere regimes, kijkt u op p. 308 (correctiefactoren)  
Prijzen in euro (excl. BTW)



# VIOLA HORIZONTAAL (H2-RO)

## HOE VIOLA HORIZONTAAL BESTELLEN

Leveringstermijn 15 - 30 werkdagen  
(zonder transportduur)



H2-RO

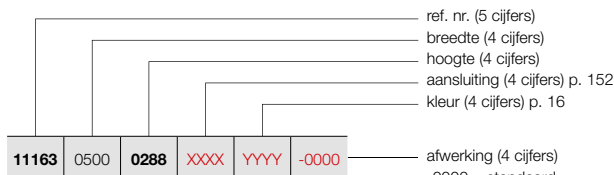

### VRIJSTAANDE OPSTELLING (H2-RO)

Zie p. 150 voor extra toebehoren.

- 0000 = standaard
- 0001 = vrijstaand (H2-RO)
- thermostaatkop geïntegreerd ventiel:
- 0003 = wit
- 0004 = chroom
- 0005 = inox
- 0007 = telescopische voeten + muurbevestigingen

BESTELCODE MAATWERK VIOLA HORIZONTAAL						TECHNISCHE GEGEVENS					STANDAARDKLEUR	ANDERE KLEUREN									
						buizen	breedte (L mm)	hoogte (H mm)	75/65/20 (Watt)	55/45/20 (Watt)	n-exp.	gewicht (kg)	inhoud (l)	el. weerst. (Watt)	prijs RAL 9016	prijs kleur					
REF. NR. VIOLA HORIZONTAAL H2-RO : 11163																					
11163	0500	0288	XXXX	YYYY	-0000	4	500	288	284	150	1,25	7,57	2,11	-	342	393					
		0360				5	500	360	348	183	1,26	9,50	2,70	-	390	449					
		0433				6	500	433	412	216	1,26	11,33	3,26	-	439	505					
		0505				7	500	505	475	250	1,26	13,13	3,80	-	487	560					
		0578				8	500	578	537	282	1,26	14,95	4,36	-	536	616					
		0650				9	500	650	598	314	1,26	16,75	4,90	-	583	670					
		0723				10	500	723	659	344	1,27	18,61	5,44	-	631	726					
		0795				11	500	795	718	373	1,28	20,44	5,97	-	680	782					
		0868				12	500	868	778	403	1,29	22,30	6,50	-	728	837					
		11163				0600	0288	XXXX	YYYY	-0000	4	600	288	340	180	1,25	9,08	2,53	-	368	423
							0360				5	600	360	418	220	1,26	11,40	3,24	-	421	484
							0433				6	600	433	494	260	1,26	13,59	3,91	-	475	546
0505	7		600	505	569		299				1,26	15,75	4,56	-	528	607					
0578	8		600	578	644		338				1,26	17,94	5,23	-	582	669					
0650	9		600	650	717		377				1,26	20,10	5,88	-	636	731					
0723	10		600	723	790		413				1,27	22,33	6,52	-	689	792					
0795	11		600	795	862		448				1,28	24,53	7,16	-	743	854					
0868	12		600	868	934		483				1,29	26,76	7,80	-	796	915					
11163	0700		0288	XXXX	YYYY		-0000				4	700	288	397	210	1,25	10,60	2,95	-	393	452
			0360								5	700	360	487	256	1,26	13,30	3,78	-	452	520
			0433								6	700	433	577	303	1,26	15,86	4,56	-	511	588
		0505	7			700		505	664	349	1,26	18,38	5,32	-	571	657					
		0578	8			700		578	752	395	1,26	20,93	6,10	-	629	723					
		0650	9			700		650	837	440	1,26	23,45	6,86	-	688	791					
		0723	10			700		723	922	482	1,27	26,05	7,61	-	748	860					
		0795	11			700		795	1005	523	1,28	28,62	8,35	-	806	927					
		0868	12			700		868	1089	563	1,29	31,22	9,10	-	865	995					
		11163	0800			0288		XXXX	YYYY	-0000	4	800	288	454	240	1,25	12,11	3,38	-	418	481
						0360					5	800	360	557	293	1,26	15,20	4,32	-	483	555
						0433					6	800	433	659	346	1,26	18,12	5,21	-	547	629
0505	7			800	505	759	399				1,26	21,00	6,08	-	612	704					
0578	8			800	578	859	451				1,26	23,92	6,97	-	677	779					
0650	9			800	650	956	502				1,26	26,80	7,84	-	741	852					
0723	10			800	723	1054	551				1,27	29,78	8,70	-	805	926					
0795	11			800	795	1149	598				1,28	32,70	9,54	-	869	999					
0868	12			800	868	1245	644				1,29	35,68	10,40	-	934	1074					
11163	0900			0288	XXXX	YYYY	-0000				4	900	288	510	269	1,25	13,63	3,80	-	444	511
				0360							5	900	360	626	329	1,26	17,10	4,86	-	514	591
				0433							6	900	433	742	390	1,26	20,39	5,86	-	584	672
		0505	7	900				505	854	449	1,26	23,63	6,84	-	653	751					
		0578	8	900				578	967	508	1,26	26,91	7,84	-	723	831					
		0650	9	900				650	1076	565	1,26	30,15	8,82	-	793	912					
		0723	10	900				723	1185	619	1,27	33,50	9,78	-	863	992					
		0795	11	900				795	1292	672	1,28	36,79	10,74	-	933	1073					
		0868	12	900				868	1400	724	1,29	40,14	11,70	-	1003	1153					

CE 05 conform EN442-1: radiatoren en convectoren

Voor de warmteafgifte van andere regimes, kijkt u op p. 308 (correctiefactoren)  
Prijzen in euro (excl. BTW)

## HOE VIOLA HORIZONTAAL BESTELLEN

Leveringstermijn 15 - 30 werkdagen  
(zonder transportduur)

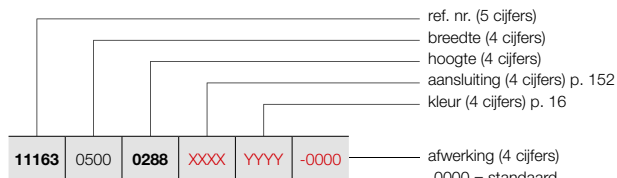

### VRIJSTAANDE OPSTELLING (H2-RO)

Zie p. 150 voor extra toebehoren.

- 0000 = standaard
- 0001 = vrijstaand (H2-RO)
- thermostaatkop geïntegreerd ventiel:
- 0003 = wit
- 0004 = chroom
- 0005 = inox
- 0007 = telescopische voeten + muurbevestigingen

## VIOLA HORIZONTAAL (H2-RO)



H2-RO

BESTELCODE MAATWERK VIOLA HORIZONTAAL	TECHNISCHE GEGEVENS									STANDAARDKLEUR	ANDERE KLEUREN											
	buizen	breedte (L mm)	hoogte (H mm)	75/65/20 (Watt)	55/45/20 (Watt)	n-exp.	gewicht (kg)	inhoud (l)	el. weerst. (Watt)	prijs RAL 9016	prijs kleur											
<b>REF. NR. VIOLA HORIZONTAAL H2-RO : 11163</b>																						
<b>11163</b>	0500	<b>0288</b>	XXXX	YYYY	-0000	4	1000	288	567	299	1,25	15,14	4,22	-	<b>470</b>	<b>541</b>						
						5	1000	360	696	366	1,26	19,00	5,40	-	<b>545</b>	<b>627</b>						
						6	1000	433	824	433	1,26	22,65	6,51	-	<b>620</b>	<b>713</b>						
						7	1000	505	949	499	1,26	26,25	7,60	-	<b>695</b>	<b>799</b>						
						8	1000	578	1074	564	1,26	29,90	8,71	-	<b>770</b>	<b>886</b>						
						9	1000	650	1195	628	1,26	33,50	9,80	-	<b>846</b>	<b>973</b>						
						10	1000	723	1317	688	1,27	37,22	10,87	-	<b>921</b>	<b>1059</b>						
						11	1000	795	1436	747	1,28	40,88	11,93	-	<b>996</b>	<b>1145</b>						
						12	1000	868	1556	805	1,29	44,60	13,00	-	<b>1071</b>	<b>1232</b>						
						<b>11163</b>	1100	<b>0288</b>	XXXX	YYYY	-0000	4	1100	288	624	330	1,25	16,65	4,64	-	<b>494</b>	<b>568</b>
												5	1100	360	766	402	1,26	20,90	5,94	-	<b>576</b>	<b>662</b>
												6	1100	433	906	476	1,26	24,92	7,16	-	<b>656</b>	<b>754</b>
7	1100	505	1044	548	1,26							28,88	8,36	-	<b>736</b>	<b>846</b>						
8	1100	578	1181	620	1,26							32,89	9,58	-	<b>818</b>	<b>941</b>						
9	1100	650	1315	691	1,26							36,85	10,78	-	<b>898</b>	<b>1033</b>						
10	1100	723	1449	757	1,27							40,94	11,96	-	<b>979</b>	<b>1126</b>						
11	1100	795	1580	822	1,28							44,97	13,12	-	<b>1060</b>	<b>1219</b>						
12	1100	868	1712	886	1,29							49,06	14,30	-	<b>1140</b>	<b>1311</b>						
<b>11163</b>	1200	<b>0288</b>	XXXX	YYYY	-0000							4	1200	288	680	359	1,25	18,17	5,06	-	<b>520</b>	<b>598</b>
												5	1200	360	835	439	1,26	22,80	6,48	-	<b>606</b>	<b>697</b>
												6	1200	433	989	520	1,26	27,18	7,81	-	<b>692</b>	<b>796</b>
						7	1200	505	1139	598	1,26	31,50	9,12	-	<b>779</b>	<b>896</b>						
						8	1200	578	1289	677	1,26	35,88	10,45	-	<b>864</b>	<b>994</b>						
						9	1200	650	1434	753	1,26	40,20	11,76	-	<b>951</b>	<b>1094</b>						
						10	1200	723	1580	826	1,27	44,66	13,04	-	<b>1036</b>	<b>1191</b>						
						11	1200	795	1723	896	1,28	49,06	14,32	-	<b>1123</b>	<b>1291</b>						
						12	1200	868	1867	966	1,29	53,52	15,60	-	<b>1209</b>	<b>1390</b>						
						<b>11163</b>	1400	<b>0288</b>	XXXX	YYYY	-0000	4	1400	288	794	419	1,25	21,20	5,91	-	<b>571</b>	<b>657</b>
												5	1400	360	974	512	1,26	26,60	7,56	-	<b>667</b>	<b>767</b>
												6	1400	433	1154	606	1,26	31,71	9,11	-	<b>764</b>	<b>879</b>
7	1400	505	1329	698	1,26							36,75	10,64	-	<b>862</b>	<b>991</b>						
8	1400	578	1504	790	1,26							41,86	12,19	-	<b>959</b>	<b>1103</b>						
9	1400	650	1673	879	1,26							46,90	13,72	-	<b>1056</b>	<b>1214</b>						
10	1400	723	1844	964	1,27							52,11	15,22	-	<b>1153</b>	<b>1326</b>						
11	1400	795	2010	1045	1,28							57,23	16,70	-	<b>1249</b>	<b>1436</b>						
12	1400	868	2178	1127	1,29							62,44	18,20	-	<b>1346</b>	<b>1548</b>						
<b>11163</b>	1600	<b>0288</b>	XXXX	YYYY	-0000							4	1600	288	907	479	1,25	24,22	6,75	-	<b>622</b>	<b>715</b>
												5	1600	360	1114	585	1,26	30,40	8,64	-	<b>729</b>	<b>838</b>
												6	1600	433	1318	692	1,26	36,24	10,42	-	<b>837</b>	<b>963</b>
						7	1600	505	1518	798	1,26	42,00	12,16	-	<b>945</b>	<b>1087</b>						
						8	1600	578	1718	903	1,26	47,84	13,94	-	<b>1053</b>	<b>1211</b>						
						9	1600	650	1912	1005	1,26	53,60	15,68	-	<b>1161</b>	<b>1335</b>						
						10	1600	723	2107	1101	1,27	59,55	17,39	-	<b>1268</b>	<b>1458</b>						
						11	1600	795	2298	1195	1,28	65,41	19,09	-	<b>1376</b>	<b>1582</b>						
						12	1600	868	2490	1288	1,29	71,36	20,80	-	<b>1483</b>	<b>1705</b>						

# VIOLA HORIZONTAAL (H2-RO)



H2-RO

## HOE VIOLA HORIZONTAAL BESTELLEN

Leveringstermijn 15 - 30 werkdagen  
(zonder transportduur)

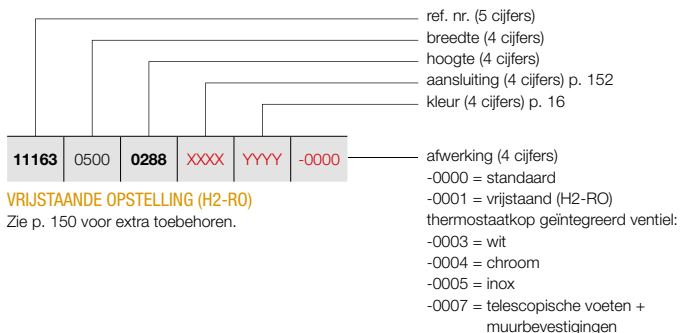

### VRIJSTAANDE OPSTELLING (H2-RO)

Zie p. 150 voor extra toebehoren.

BESTELCODE MAATWERK VIOLA HORIZONTAAL						TECHNISCHE GEGEVENS							STANDAARDKLEUR	ANDERE KLEUREN							
						buizen	breedte (L mm)	hoogte (H mm)	75/65/20 (Watt)	55/45/20 (Watt)	n-exp.	gewicht (kg)	inhoud (l)	el. weerst. (Watt)	prijs RAL 9016	prijs kleur					
REF. NR. VIOLA HORIZONTAAL H2-RO : 11163																					
11163	1800	0288	XXXX	YYYY	-0000	4	1800	288	1021	539	1,25	27,25	7,60	-	673	774					
		0360				5	1800	360	1253	658	1,26	34,20	9,72	-	791	910					
		0433				6	1800	433	1483	779	1,26	40,77	11,72	-	909	1045					
		0505				7	1800	505	1708	897	1,26	47,25	13,68	-	1028	1182					
		0578				8	1800	578	1933	1016	1,26	53,82	15,68	-	1146	1318					
		0650				9	1800	650	2151	1130	1,26	60,30	17,64	-	1265	1455					
		0723				10	1800	723	2371	1239	1,27	67,00	19,57	-	1384	1592					
		0795				11	1800	795	2585	1344	1,28	73,58	21,47	-	1503	1728					
		0868				12	1800	868	2801	1449	1,29	80,28	23,40	-	1621	1864					
		11163				2000	0288	XXXX	YYYY	-0000	4	2000	288	1134	599	1,25	30,28	8,44	-	723	831
							0360				5	2000	360	1392	731	1,26	38,00	10,80	-	853	981
							0433				6	2000	433	1648	866	1,26	45,30	13,02	-	982	1129
0505	7		2000	505	1898		997				1,26	52,50	15,20	-	1111	1278					
0578	8		2000	578	2148		1129				1,26	59,80	17,42	-	1241	1427					
0650	9		2000	650	2390		1256				1,26	67,00	19,60	-	1370	1576					
0723	10		2000	723	2634		1377				1,27	74,44	21,74	-	1500	1725					
0795	11		2000	795	2872		1494				1,28	81,76	23,86	-	1629	1873					
0868	12		2000	868	3112		1610				1,29	89,20	26,00	-	1758	2022					
11163	2200		0288	XXXX	YYYY		-0000				4	2200	288	1247	658	1,25	33,31	9,28	-	774	890
			0360								5	2200	360	1531	804	1,26	41,80	11,88	-	915	1052
			0433								6	2200	433	1813	953	1,26	49,83	14,32	-	1055	1213
		0505	7			2200		505	2088	1097	1,26	57,75	16,72	-	1195	1374					
		0578	8			2200		578	2363	1241	1,26	65,78	19,16	-	1335	1535					
		0650	9			2200		650	2629	1381	1,26	73,70	21,56	-	1475	1696					
		0723	10			2200		723	2897	1514	1,27	81,88	23,91	-	1615	1857					
		0795	11			2200		795	3159	1643	1,28	89,94	26,25	-	1756	2019					
		0868	12			2200		868	3423	1771	1,29	98,12	28,60	-	1896	2180					
		11163	2400			0288		XXXX	YYYY	-0000	4	2400	288	1361	719	1,25	36,34	10,13	-	825	949
						0360					5	2400	360	1670	877	1,26	45,60	12,96	-	975	1121
						0433					6	2400	433	1978	1039	1,26	54,36	15,62	-	1127	1296
0505	7			2400	505	2278	1197				1,26	63,00	18,24	-	1278	1470					
0578	8			2400	578	2578	1354				1,26	71,76	20,90	-	1429	1643					
0650	9			2400	650	2868	1507				1,26	80,40	23,52	-	1580	1817					
0723	10			2400	723	3161	1652				1,27	89,33	26,09	-	1731	1991					
0795	11			2400	795	3446	1792				1,28	98,11	28,63	-	1882	2164					
0868	12			2400	868	3734	1932				1,29	107,04	31,20	-	2033	2338					
11163	2600			0288	XXXX	YYYY	-0000				4	2600	288	1474	778	1,25	39,36	10,97	-	876	1007
				0360							5	2600	360	1810	951	1,26	49,40	14,04	-	1037	1193
				0433							6	2600	433	2142	1125	1,26	58,89	16,93	-	1199	1379
		0505	7	2600				505	2467	1296	1,26	68,25	19,76	-	1362	1566					
		0578	8	2600				578	2792	1467	1,26	77,74	22,65	-	1523	1751					
		0650	9	2600				650	3107	1632	1,26	87,10	25,48	-	1685	1938					
		0723	10	2600				723	3424	1790	1,27	96,77	28,26	-	1847	2124					
		0795	11	2600				795	3734	1942	1,28	106,29	31,02	-	2009	2310					
		0868	12	2600				868	4046	2093	1,29	115,96	33,80	-	2171	2497					

CE 05 conform EN442-1: radiatoren en convectoren

Voor de warmteafgiftes van andere regimes, kijkt u op p. 308 (correctiefactoren)  
 Prijzen in euro (excl. BTW)

## HOE VIOLA HORIZONTAAL BESTELLEN

Leveringstermijn 15 - 30 werkdagen  
(zonder transportduur)

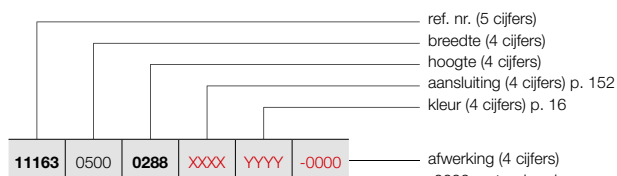

### VRIJSTAANDE OPSTELLING (H2-RO)

Zie p. 150 voor extra toebehoren.

## VIOLA HORIZONTAAL (H2-RO)



H2-RO

BESTELCODE MAATWERK VIOLA HORIZONTAAL	TECHNISCHE GEGEVENS									STANDAARDKLEUR	ANDERE KLEUREN					
	buizen	breedte (L mm)	hoogte (H mm)	75/65/20 (Watt)	55/45/20 (Watt)	n-exp.	gewicht (kg)	inhoud (l)	el. weerst. (Watt)	prijs RAL 9016	prijs kleur					
<b>REF. NR. VIOLA HORIZONTAAL H2-RO : 11163</b>																
<b>11163</b>	<b>2800</b>	<b>0288</b>	<b>XXXX</b>	<b>YYYY</b>	<b>-0000</b>	4	2800	288	1588	839	1,25	42,39	11,82	-	<b>926</b>	<b>1065</b>
		<b>0360</b>				5	2800	360	1949	1024	1,26	53,20	15,12	-	<b>1099</b>	<b>1264</b>
		<b>0433</b>				6	2800	433	2307	1212	1,26	63,42	18,23	-	<b>1272</b>	<b>1463</b>
		<b>0505</b>				7	2800	505	2657	1396	1,26	73,50	21,28	-	<b>1444</b>	<b>1661</b>
		<b>0578</b>				8	2800	578	3007	1580	1,26	83,72	24,39	-	<b>1617</b>	<b>1860</b>
		<b>0650</b>				9	2800	650	3346	1758	1,26	93,80	27,44	-	<b>1790</b>	<b>2059</b>
		<b>0723</b>				10	2800	723	3688	1928	1,27	104,22	30,44	-	<b>1963</b>	<b>2257</b>
		<b>0795</b>				11	2800	795	4021	2091	1,28	114,46	33,40	-	<b>2135</b>	<b>2455</b>
		<b>0868</b>				12	2800	868	4357	2254	1,29	124,88	36,40	-	<b>2308</b>	<b>2654</b>
<b>11163</b>	<b>3000</b>	<b>0288</b>	<b>XXXX</b>	<b>YYYY</b>	<b>-0000</b>	4	3000	288	1701	898	1,25	45,42	12,66	-	<b>977</b>	<b>1124</b>
		<b>0360</b>				5	3000	360	2088	1097	1,26	57,00	16,20	-	<b>1161</b>	<b>1335</b>
		<b>0433</b>				6	3000	433	2472	1299	1,26	67,95	19,53	-	<b>1344</b>	<b>1546</b>
		<b>0505</b>				7	3000	505	2847	1496	1,26	78,75	22,80	-	<b>1527</b>	<b>1756</b>
		<b>0578</b>				8	3000	578	3222	1693	1,26	89,70	26,13	-	<b>1711</b>	<b>1968</b>
		<b>0650</b>				9	3000	650	3585	1883	1,26	100,50	29,40	-	<b>1895</b>	<b>2179</b>
		<b>0723</b>				10	3000	723	3951	2065	1,27	111,66	32,61	-	<b>2079</b>	<b>2391</b>
		<b>0795</b>				11	3000	795	4308	2240	1,28	122,64	35,79	-	<b>2262</b>	<b>2601</b>
		<b>0868</b>				12	3000	868	4668	2415	1,29	133,80	39,00	-	<b>2445</b>	<b>2812</b>

CE 05 conform EN442-1: radiatoren en convectoren

Voor de warmteafgiftes van andere regimes, kijkt u op p. 308 (correctiefactoren)

Prijzen in euro (excl. BTW)

# VIOLA HORIZONTAAL (H2L1-RO)

## HOE VIOLA HORIZONTAAL BESTELLEN

Leveringstermijn 15 - 30 werkdagen  
(zonder transportduur)



H2L1-RO

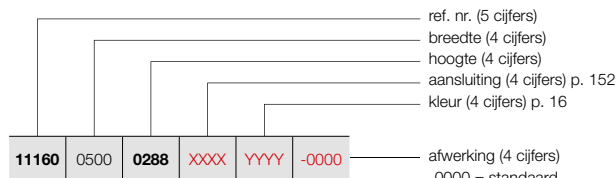

### VRIJSTAANDE OPSTELLING (H2L1-RO)

Zie p. 150 voor extra toebehoren.

BESTELCODE MAATWERK VIOLA HORIZONTAAL						TECHNISCHE GEGEVENS							STANDAARDKLEUR	ANDERE KLEUREN							
						buizen	breedte (L mm)	hoogte (H mm)	75/65/20 (Watt)	55/45/20 (Watt)	n-exp.	gewicht (kg)	inhoud (l)	el. weerst. (Watt)	prijs RAL 9016	prijs kleur					
REF. NR. VIOLA HORIZONTAAL H2L1-RO : 11160																					
11160	0500	0288	XXXX	YYYY	-0000	4	500	288	397	206	1,28	8,69	2,13	-	380	437					
		0360				5	500	360	475	246	1,29	10,75	2,65	-	441	507					
		0433				6	500	433	550	286	1,28	12,68	3,22	-	502	577					
		0505				7	500	505	623	324	1,28	14,58	3,78	-	562	646					
		0578				8	500	578	694	361	1,28	16,50	4,34	-	623	716					
		0650				9	500	650	762	396	1,28	18,40	4,90	-	685	788					
		0723				10	500	723	830	432	1,28	20,21	5,44	-	746	858					
		0795				11	500	795	896	466	1,28	21,99	5,97	-	806	927					
		0868				12	500	868	962	500	1,28	23,80	6,50	-	867	997					
		11160				0600	0288	XXXX	YYYY	-0000	4	600	288	476	248	1,28	10,43	2,56	-	410	472
							0360				5	600	360	569	294	1,29	12,90	3,18	-	477	549
							0433				6	600	433	660	343	1,28	15,21	3,86	-	544	626
0505	7		600	505	747		388				1,28	17,49	4,53	-	612	704					
0578	8		600	578	832		433				1,28	19,80	5,21	-	679	781					
0650	9		600	650	914		475				1,28	22,08	5,88	-	747	859					
0723	10		600	723	996		518				1,28	24,25	6,52	-	814	936					
0795	11		600	795	1075		559				1,28	26,39	7,16	-	882	1014					
0868	12		600	868	1154		600				1,28	28,56	7,80	-	949	1091					
11160	0700		0288	XXXX	YYYY		-0000				4	700	288	556	289	1,28	12,17	2,98	-	439	505
			0360								5	700	360	664	344	1,29	15,05	3,71	-	513	590
			0433								6	700	433	770	400	1,28	17,75	4,50	-	587	675
		0505	7			700		505	872	453	1,28	20,41	5,29	-	660	759					
		0578	8			700		578	971	505	1,28	23,10	6,08	-	734	844					
		0650	9			700		650	1067	555	1,28	25,76	6,86	-	809	930					
		0723	10			700		723	1162	604	1,28	28,29	7,61	-	883	1015					
		0795	11			700		795	1254	652	1,28	30,79	8,35	-	956	1099					
		0868	12			700		868	1346	700	1,28	33,32	9,10	-	1030	1185					
		11160	0800			0288		XXXX	YYYY	-0000	4	800	288	635	330	1,28	13,90	3,41	-	469	539
						0360					5	800	360	759	393	1,29	17,20	4,24	-	549	631
						0433					6	800	433	880	458	1,28	20,28	5,14	-	629	723
0505	7			800	505	996	518				1,28	23,32	6,04	-	710	817					
0578	8			800	578	1110	577				1,28	26,40	6,94	-	790	909					
0650	9			800	650	1219	634				1,28	29,44	7,84	-	870	1001					
0723	10			800	723	1328	691				1,28	32,34	8,70	-	951	1094					
0795	11			800	795	1434	746				1,28	35,18	9,54	-	1031	1186					
0868	12			800	868	1538	800				1,28	38,08	10,40	-	1111	1278					
11160	0900			0288	XXXX	YYYY	-0000				4	900	288	715	372	1,28	15,64	3,83	-	499	574
				0360							5	900	360	854	442	1,29	19,35	4,77	-	585	673
				0433							6	900	433	990	515	1,28	22,82	5,79	-	672	773
		0505	7	900				505	1121	583	1,28	26,24	6,80	-	759	873					
		0578	8	900				578	1248	649	1,28	29,70	7,81	-	846	973					
		0650	9	900				650	1372	713	1,28	33,12	8,82	-	932	1072					
		0723	10	900				723	1494	777	1,28	36,38	9,78	-	1020	1173					
		0795	11	900				795	1613	839	1,28	39,58	10,74	-	1106	1272					
		0868	12	900				868	1731	900	1,28	42,84	11,70	-	1193	1372					

CE 05 conform EN442-1: radiatoren en convectoren

Voor de warmteafgifte van andere regimes, kijkt u op p. 308 (correctiefactoren)  
Prijzen in euro (excl. BTW)

## HOE VIOLA HORIZONTAAL BESTELLEN

Leveringstermijn 15 - 30 werkdagen  
(zonder transportduur)

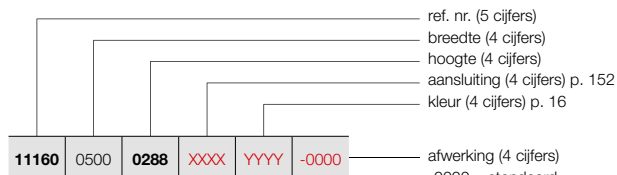

## VRIJSTAANDE OPSTELLING (H2L1-RO)

Zie p. 150 voor extra toebehoren.

- 0000 = standaard
- 0001 = vrijstaand (H2L1-RO)
- thermostaatkop geïntegreerd ventiel:
- 0003 = wit
- 0004 = chroom
- 0005 = inox
- 0007 = telescopische voeten + muurbevestigingen

## VIOLA HORIZONTAAL (H2L1-RO)



H2L1-RO

BESTELCODE MAATWERK VIOLA HORIZONTAAL	TECHNISCHE GEGEVENS									STANDAARDKLEUR	ANDERE KLEUREN					
	buizen	breedte (L mm)	hoogte (H mm)	75/65/20 (Watt)	55/45/20 (Watt)	n-exp.	gewicht (kg)	inhoud (l)	el. weerst. (Watt)	prijs RAL 9016	prijs kleur					
<b>REF. NR. VIOLA HORIZONTAAL H2L1-RO : 11160</b>																
<b>11160</b>	<b>1000</b>	<b>0288</b>	<b>XXXX</b>	<b>YYYY</b>	<b>-0000</b>	4	1000	288	794	413	1,28	17,38	4,26	-	<b>528</b>	<b>607</b>
		<b>0360</b>				5	1000	360	949	491	1,29	21,50	5,30	-	<b>621</b>	<b>714</b>
		<b>0433</b>				6	1000	433	1100	572	1,28	25,35	6,43	-	<b>715</b>	<b>822</b>
		<b>0505</b>				7	1000	505	1245	647	1,28	29,15	7,55	-	<b>808</b>	<b>929</b>
		<b>0578</b>				8	1000	578	1387	721	1,28	33,00	8,68	-	<b>901</b>	<b>1036</b>
		<b>0650</b>				9	1000	650	1524	793	1,28	36,80	9,80	-	<b>994</b>	<b>1143</b>
		<b>0723</b>				10	1000	723	1660	863	1,28	40,42	10,87	-	<b>1088</b>	<b>1251</b>
		<b>0795</b>				11	1000	795	1792	932	1,28	43,98	11,93	-	<b>1181</b>	<b>1358</b>
		<b>0868</b>				12	1000	868	1923	1000	1,28	47,60	13,00	-	<b>1274</b>	<b>1465</b>
<b>11160</b>	<b>1100</b>	<b>0288</b>	<b>XXXX</b>	<b>YYYY</b>	<b>-0000</b>	4	1100	288	873	454	1,28	19,12	4,69	-	<b>557</b>	<b>641</b>
		<b>0360</b>				5	1100	360	1044	540	1,29	23,65	5,83	-	<b>657</b>	<b>756</b>
		<b>0433</b>				6	1100	433	1210	629	1,28	27,89	7,07	-	<b>757</b>	<b>871</b>
		<b>0505</b>				7	1100	505	1370	712	1,28	32,07	8,31	-	<b>857</b>	<b>986</b>
		<b>0578</b>				8	1100	578	1526	794	1,28	36,30	9,55	-	<b>957</b>	<b>1101</b>
		<b>0650</b>				9	1100	650	1676	872	1,28	40,48	10,78	-	<b>1057</b>	<b>1216</b>
		<b>0723</b>				10	1100	723	1826	950	1,28	44,46	11,96	-	<b>1156</b>	<b>1329</b>
		<b>0795</b>				11	1100	795	1971	1025	1,28	48,38	13,12	-	<b>1256</b>	<b>1444</b>
		<b>0868</b>				12	1100	868	2115	1100	1,28	52,36	14,30	-	<b>1355</b>	<b>1558</b>
<b>11160</b>	<b>1200</b>	<b>0288</b>	<b>XXXX</b>	<b>YYYY</b>	<b>-0000</b>	4	1200	288	953	496	1,28	20,86	5,11	-	<b>587</b>	<b>675</b>
		<b>0360</b>				5	1200	360	1139	589	1,29	25,80	6,36	-	<b>693</b>	<b>797</b>
		<b>0433</b>				6	1200	433	1320	686	1,28	30,42	7,72	-	<b>799</b>	<b>919</b>
		<b>0505</b>				7	1200	505	1494	777	1,28	34,98	9,06	-	<b>906</b>	<b>1042</b>
		<b>0578</b>				8	1200	578	1664	865	1,28	39,60	10,42	-	<b>1012</b>	<b>1164</b>
		<b>0650</b>				9	1200	650	1829	951	1,28	44,16	11,76	-	<b>1119</b>	<b>1287</b>
		<b>0723</b>				10	1200	723	1992	1036	1,28	48,50	13,04	-	<b>1225</b>	<b>1409</b>
		<b>0795</b>				11	1200	795	2150	1118	1,28	52,78	14,32	-	<b>1331</b>	<b>1531</b>
		<b>0868</b>				12	1200	868	2308	1200	1,28	57,12	15,60	-	<b>1437</b>	<b>1653</b>
<b>11160</b>	<b>1400</b>	<b>0288</b>	<b>XXXX</b>	<b>YYYY</b>	<b>-0000</b>	4	1400	288	1112	578	1,28	24,33	5,96	-	<b>647</b>	<b>744</b>
		<b>0360</b>				5	1400	360	1329	688	1,29	30,10	7,42	-	<b>765</b>	<b>880</b>
		<b>0433</b>				6	1400	433	1540	801	1,28	35,49	9,00	-	<b>885</b>	<b>1018</b>
		<b>0505</b>				7	1400	505	1743	906	1,28	40,81	10,57	-	<b>1004</b>	<b>1155</b>
		<b>0578</b>				8	1400	578	1942	1010	1,28	46,20	12,15	-	<b>1123</b>	<b>1291</b>
		<b>0650</b>				9	1400	650	2134	1110	1,28	51,52	13,72	-	<b>1242</b>	<b>1428</b>
		<b>0723</b>				10	1400	723	2324	1209	1,28	56,59	15,22	-	<b>1362</b>	<b>1566</b>
		<b>0795</b>				11	1400	795	2509	1305	1,28	61,57	16,70	-	<b>1480</b>	<b>1702</b>
		<b>0868</b>				12	1400	868	2692	1400	1,28	66,64	18,20	-	<b>1600</b>	<b>1840</b>
<b>11160</b>	<b>1600</b>	<b>0288</b>	<b>XXXX</b>	<b>YYYY</b>	<b>-0000</b>	4	1600	288	1270	660	1,28	27,81	6,82	-	<b>706</b>	<b>812</b>
		<b>0360</b>				5	1600	360	1518	785	1,29	34,40	8,48	-	<b>837</b>	<b>963</b>
		<b>0433</b>				6	1600	433	1760	915	1,28	40,56	10,29	-	<b>970</b>	<b>1116</b>
		<b>0505</b>				7	1600	505	1992	1036	1,28	46,64	12,08	-	<b>1102</b>	<b>1267</b>
		<b>0578</b>				8	1600	578	2219	1154	1,28	52,80	13,89	-	<b>1234</b>	<b>1419</b>
		<b>0650</b>				9	1600	650	2438	1268	1,28	58,88	15,68	-	<b>1366</b>	<b>1571</b>
		<b>0723</b>				10	1600	723	2656	1381	1,28	64,67	17,39	-	<b>1499</b>	<b>1724</b>
		<b>0795</b>				11	1600	795	2867	1491	1,28	70,37	19,09	-	<b>1630</b>	<b>1875</b>
		<b>0868</b>				12	1600	868	3077	1600	1,28	76,16	20,80	-	<b>1762</b>	<b>2026</b>

CE 05 conform EN442-1: radiatoren en convectoren

Voor de warmteafgiftes van andere regimes, kijkt u op p. 308 (correctiefactoren)  
Prijzen in euro (excl. BTW)

# VIOLA HORIZONTAAL (H2L1-RO)



H2L1-RO

## HOE VIOLA HORIZONTAAL BESTELLEN

Leveringstermijn 15 - 30 werkdagen  
(zonder transportduur)

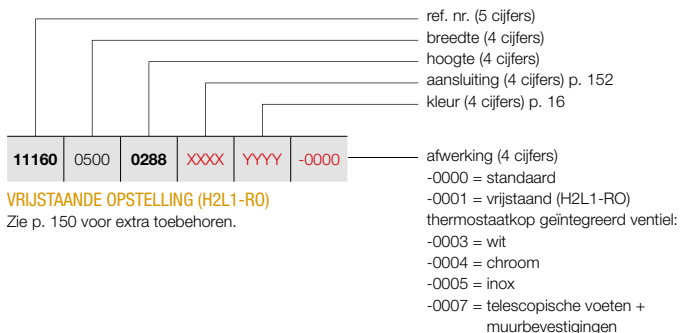

## VRIJSTAANDE OPSTELLING (H2L1-RO)

Zie p. 150 voor extra toebehoren.

BESTELCODE MAATWERK VIOLA HORIZONTAAL						TECHNISCHE GEGEVENS						STANDAARDKLEUR	ANDERE KLEUREN								
						buizen	breedte (L mm)	hoogte (H mm)	75/65/20 (Watt)	55/45/20 (Watt)	n-exp.	gewicht (kg)	inhoud (l)	el. weerst. (Watt)	prijs RAL 9016	prijs kleur					
REF. NR. VIOLA HORIZONTAAL H2L1-RO : 11160																					
11160	1800	0288	XXXX	YYYY	-0000	4	1800	288	1429	743	1,28	31,28	7,67	-	765	880					
		0360				5	1800	360	1708	884	1,29	38,70	9,54	-	911	1048					
		0433				6	1800	433	1980	1030	1,28	45,63	11,57	-	1055	1213					
		0505				7	1800	505	2241	1165	1,28	52,47	13,59	-	1200	1380					
		0578				8	1800	578	2497	1299	1,28	59,40	15,62	-	1345	1547					
		0650				9	1800	650	2743	1426	1,28	66,24	17,64	-	1490	1714					
		0723				10	1800	723	2988	1554	1,28	72,76	19,57	-	1636	1881					
		0795				11	1800	795	3226	1678	1,28	79,16	21,47	-	1780	2047					
		0868				12	1800	868	3461	1800	1,28	85,68	23,40	-	1925	2214					
		11160				2000	0288	XXXX	YYYY	-0000	4	2000	288	1588	826	1,28	34,76	8,52	-	824	948
							0360				5	2000	360	1898	982	1,29	43,00	10,60	-	983	1130
							0433				6	2000	433	2200	1144	1,28	50,70	12,86	-	1140	1311
0505	7		2000	505	2490		1295				1,28	58,30	15,10	-	1298	1493					
0578	8		2000	578	2774		1443				1,28	66,00	17,36	-	1456	1674					
0650	9		2000	650	3048		1585				1,28	73,60	19,60	-	1614	1856					
0723	10		2000	723	3320		1727				1,28	80,84	21,74	-	1773	2039					
0795	11		2000	795	3584		1864				1,28	87,96	23,86	-	1930	2220					
0868	12		2000	868	3846		2000				1,28	95,20	26,00	-	2088	2401					
11160	2200		0288	XXXX	YYYY		-0000				4	2200	288	1747	909	1,28	38,24	9,37	-	884	1017
			0360								5	2200	360	2088	1080	1,29	47,30	11,66	-	1055	1213
			0433								6	2200	433	2420	1258	1,28	55,77	14,15	-	1226	1410
		0505	7			2200		505	2739	1424	1,28	64,13	16,61	-	1397	1607					
		0578	8			2200		578	3051	1587	1,28	72,60	19,10	-	1568	1803					
		0650	9			2200		650	3353	1744	1,28	80,96	21,56	-	1738	1999					
		0723	10			2200		723	3652	1899	1,28	88,92	23,91	-	1909	2195					
		0795	11			2200		795	3942	2050	1,28	96,76	26,25	-	2080	2392					
		0868	12			2200		868	4231	2200	1,28	104,72	28,60	-	2251	2589					
		11160	2400			0288		XXXX	YYYY	-0000	4	2400	288	1906	991	1,28	41,71	10,22	-	942	1083
						0360					5	2400	360	2278	1179	1,29	51,60	12,72	-	1127	1296
						0433					6	2400	433	2640	1373	1,28	60,84	15,43	-	1310	1507
0505	7			2400	505	2988	1554				1,28	69,96	18,12	-	1495	1719					
0578	8			2400	578	3329	1731				1,28	79,20	20,83	-	1678	1930					
0650	9			2400	650	3658	1902				1,28	88,32	23,52	-	1862	2141					
0723	10			2400	723	3984	2072				1,28	97,01	26,09	-	2046	2353					
0795	11			2400	795	4301	2237				1,28	105,55	28,63	-	2230	2565					
0868	12			2400	868	4615	2400				1,28	114,24	31,20	-	2413	2775					
11160	2600			0288	XXXX	YYYY	-0000				4	2600	288	2064	1073	1,28	45,19	11,08	-	1002	1152
				0360							5	2600	360	2467	1276	1,29	55,90	13,78	-	1199	1379
				0433							6	2600	433	2860	1487	1,28	65,91	16,72	-	1396	1605
		0505	7	2600				505	3237	1683	1,28	75,79	19,63	-	1592	1831					
		0578	8	2600				578	3606	1875	1,28	85,80	22,57	-	1789	2057					
		0650	9	2600				650	3962	2060	1,28	95,68	25,48	-	1986	2284					
		0723	10	2600				723	4316	2244	1,28	105,09	28,26	-	2183	2510					
		0795	11	2600				795	4659	2423	1,28	114,35	31,02	-	2379	2736					
		0868	12	2600				868	5000	2600	1,28	123,76	33,80	-	2576	2962					

CE 05 conform EN442-1: radiatoren en convectoren

Voor de warmteafgifte van andere regimes, kijkt u op p. 308 (correctiefactoren)  
 Prijzen in euro (excl. BTW)

## HOE VIOLA HORIZONTAAL BESTELLEN

Leveringstermijn 15 - 30 werkdagen  
(zonder transportduur)

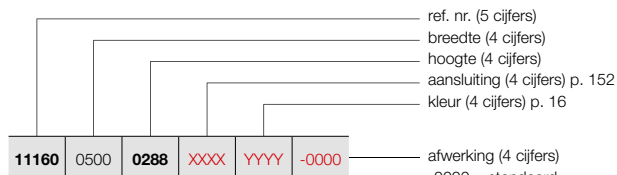

### VRIJSTAANDE OPSTELLING (H2L1-RO)

Zie p. 150 voor extra toebehoren.

## VIOLA HORIZONTAAL (H2L1-RO)



H2L1-RO

BESTELCODE MAATWERK VIOLA HORIZONTAAL	TECHNISCHE GEGEVENS									STANDAARDKLEUR	ANDERE KLEUREN					
	buizen	breedte (L mm)	hoogte (H mm)	75/65/20 (Watt)	55/45/20 (Watt)	n-exp.	gewicht (kg)	inhoud (l)	el. weerst. (Watt)	prijs RAL 9016	prijs kleur					
<b>REF. NR. VIOLA HORIZONTAAL H2L1-RO : 11160</b>																
<b>11160</b>	<b>2800</b>	<b>0288</b>	<b>XXXX</b>	<b>YYYY</b>	<b>-0000</b>	4	2800	288	2223	1156	1,28	48,66	11,93	-	<b>1061</b>	<b>1220</b>
		<b>0360</b>				5	2800	360	2657	1375	1,29	60,20	14,84	-	<b>1271</b>	<b>1462</b>
		<b>0433</b>				6	2800	433	3080	1602	1,28	70,98	18,00	-	<b>1481</b>	<b>1703</b>
		<b>0505</b>				7	2800	505	3486	1813	1,28	81,62	21,14	-	<b>1690</b>	<b>1944</b>
		<b>0578</b>				8	2800	578	3884	2020	1,28	92,40	24,30	-	<b>1900</b>	<b>2185</b>
		<b>0650</b>				9	2800	650	4267	2219	1,28	103,04	27,44	-	<b>2110</b>	<b>2427</b>
		<b>0723</b>				10	2800	723	4648	2417	1,28	113,18	30,44	-	<b>2320</b>	<b>2668</b>
		<b>0795</b>				11	2800	795	5018	2610	1,28	123,14	33,40	-	<b>2530</b>	<b>2910</b>
		<b>0868</b>				12	2800	868	5384	2800	1,28	133,28	36,40	-	<b>2739</b>	<b>3150</b>
<b>11160</b>	<b>3000</b>	<b>0288</b>	<b>XXXX</b>	<b>YYYY</b>	<b>-0000</b>	4	3000	288	2382	1239	1,28	52,14	12,78	-	<b>1121</b>	<b>1289</b>
		<b>0360</b>				5	3000	360	2847	1473	1,29	64,50	15,90	-	<b>1343</b>	<b>1544</b>
		<b>0433</b>				6	3000	433	3300	1716	1,28	76,05	19,29	-	<b>1566</b>	<b>1801</b>
		<b>0505</b>				7	3000	505	3735	1942	1,28	87,45	22,65	-	<b>1788</b>	<b>2056</b>
		<b>0578</b>				8	3000	578	4161	2164	1,28	99,00	26,04	-	<b>2012</b>	<b>2314</b>
		<b>0650</b>				9	3000	650	4572	2378	1,28	110,40	29,40	-	<b>2234</b>	<b>2569</b>
		<b>0723</b>				10	3000	723	4980	2590	1,28	121,26	32,61	-	<b>2457</b>	<b>2826</b>
		<b>0795</b>				11	3000	795	5376	2796	1,28	131,94	35,79	-	<b>2679</b>	<b>3081</b>
		<b>0868</b>				12	3000	868	5769	3000	1,28	142,80	39,00	-	<b>2902</b>	<b>3337</b>

CE05 conform EN442-1: radiatoren en convectoren

Voor de warmteafgiftes van andere regimes, kijkt u op p. 308 (correctiefactoren)  
Prijzen in euro (excl. BTW)



# VIOLA HORIZONTAAL (H2L2-RO)

## HOE VIOLA HORIZONTAAL BESTELLEN

Leveringstermijn 15 - 30 werkdagen  
(zonder transportduur)



H2L2-RO

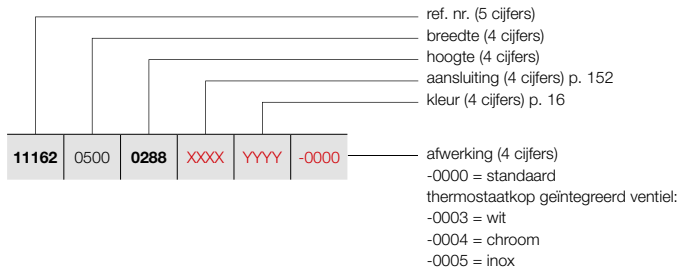

BESTELCODE MAATWERK VIOLA HORIZONTAAL						TECHNISCHE GEGEVENS							STANDAARDKLEUR	ANDERE KLEUREN		
buizen	breedte (L mm)	hoogte (H mm)	75/65/20 (Watt)	55/45/20 (Watt)	n-exp.	gewicht (kg)	inhoud (l)	el. weerst. (Watt)	prijs RAL 9016			prijs kleur				
REF. NR. VIOLA HORIZONTAAL H2L2-RO : 11162																
11162	0500	0288	XXXX	YYYY	-0000	4	500	288	488	254	1,28	11,07	2,13	-	411	473
		0360				5	500	360	584	301	1,30	13,80	2,65	-	480	552
		0433				6	500	433	675	347	1,30	16,18	3,22	-	549	631
		0505				7	500	505	761	392	1,30	18,53	3,78	-	617	710
		0578				8	500	578	843	434	1,30	20,90	4,34	-	686	789
		0650				9	500	650	921	474	1,30	23,25	4,90	-	755	868
		0723				10	500	723	996	513	1,30	25,60	5,44	-	824	948
		0795				11	500	795	1067	549	1,30	27,91	5,97	-	892	1026
		0868				12	500	868	1137	585	1,30	30,25	6,50	-	961	1105
11162	0600	0288	XXXX	YYYY	-0000	4	600	288	586	305	1,28	13,28	2,56	-	447	514
		0360				5	600	360	700	360	1,30	16,56	3,18	-	524	603
		0433				6	600	433	810	417	1,30	19,41	3,86	-	600	690
		0505				7	600	505	913	470	1,30	22,23	4,53	-	678	780
		0578				8	600	578	1012	521	1,30	25,08	5,21	-	754	867
		0650				9	600	650	1105	569	1,30	27,90	5,88	-	831	956
		0723				10	600	723	1195	615	1,30	30,71	6,52	-	907	1043
		0795				11	600	795	1280	659	1,30	33,49	7,16	-	985	1133
		0868				12	600	868	1364	702	1,30	36,30	7,80	-	1061	1220
11162	0700	0288	XXXX	YYYY	-0000	4	700	288	683	355	1,28	15,50	2,98	-	483	555
		0360				5	700	360	817	421	1,30	19,32	3,71	-	568	653
		0433				6	700	433	945	486	1,30	22,65	4,50	-	652	750
		0505				7	700	505	1065	548	1,30	25,94	5,29	-	737	848
		0578				8	700	578	1180	607	1,30	29,26	6,08	-	822	945
		0650				9	700	650	1289	664	1,30	32,55	6,86	-	906	1042
		0723				10	700	723	1394	718	1,30	35,83	7,61	-	992	1141
		0795				11	700	795	1494	769	1,30	39,07	8,35	-	1076	1237
		0868				12	700	868	1591	819	1,30	42,35	9,10	-	1161	1335
11162	0800	0288	XXXX	YYYY	-0000	4	800	288	781	406	1,28	17,71	3,41	-	519	597
		0360				5	800	360	934	481	1,30	22,08	4,24	-	612	704
		0433				6	800	433	1080	556	1,30	25,88	5,14	-	705	811
		0505				7	800	505	1217	626	1,30	29,64	6,04	-	797	917
		0578				8	800	578	1349	694	1,30	33,44	6,94	-	890	1024
		0650				9	800	650	1473	758	1,30	37,20	7,84	-	983	1130
		0723				10	800	723	1594	821	1,30	40,95	8,70	-	1075	1236
		0795				11	800	795	1707	879	1,30	44,65	9,54	-	1169	1344
		0868				12	800	868	1818	936	1,30	48,40	10,40	-	1262	1451
11162	0900	0288	XXXX	YYYY	-0000	4	900	288	878	457	1,28	19,93	3,83	-	554	637
		0360				5	900	360	1050	540	1,30	24,84	4,77	-	655	753
		0433				6	900	433	1215	625	1,30	29,12	5,79	-	756	869
		0505				7	900	505	1369	705	1,30	33,35	6,80	-	857	986
		0578				8	900	578	1517	781	1,30	37,62	7,81	-	958	1102
		0650				9	900	650	1657	853	1,30	41,85	8,82	-	1059	1218
		0723				10	900	723	1793	923	1,30	46,07	9,78	-	1160	1334
		0795				11	900	795	1921	989	1,30	50,23	10,74	-	1261	1450
		0868				12	900	868	2046	1053	1,30	54,45	11,70	-	1362	1566

CE 05 conform EN442-1: radiatoren en convectoren

Voor de warmteafgifte van andere regimes, kijkt u op p. 308 (correctiefactoren)  
Prijzen in euro (excl. BTW)

## HOE VIOLA HORIZONTAAL BESTELLEN

Leveringstermijn 15 - 30 werkdagen  
(zonder transportduur)

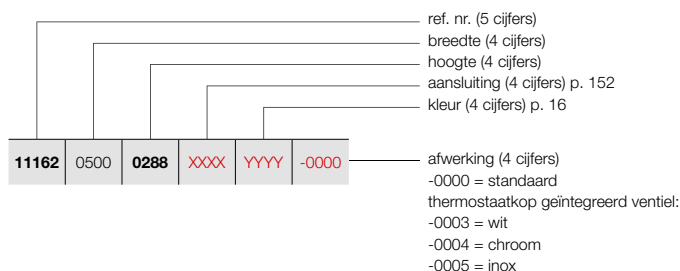

## VIOLA HORIZONTAAL (H2L2-RO)



H2L2-RO

BESTELCODE MAATWERK VIOLA HORIZONTAAL	TECHNISCHE GEGEVENS									STANDAARDKLEUR	ANDERE KLEUREN										
	buizen	breedte (L mm)	hoogte (H mm)	75/65/20 (Watt)	55/45/20 (Watt)	n-exp.	gewicht (kg)	inhoud (l)	el. weerst. (Watt)	prijs RAL 9016	prijs kleur										
<b>REF. NR. VIOLA HORIZONTAAL H2L2-RO : 11162</b>																					
11162	1000	0288	XXXX	YYYY	-0000	4	1000	288	976	508	1,28	22,14	4,26	-	590	679					
		0360				5	1000	360	1167	601	1,30	27,60	5,30	-	699	804					
		0433				6	1000	433	1350	695	1,30	32,35	6,43	-	809	930					
		0505				7	1000	505	1521	783	1,30	37,05	7,55	-	917	1055					
		0578				8	1000	578	1686	868	1,30	41,80	8,68	-	1026	1180					
		0650				9	1000	650	1841	948	1,30	46,50	9,80	-	1135	1305					
		0723				10	1000	723	1992	1025	1,30	51,19	10,87	-	1244	1431					
		0795				11	1000	795	2134	1098	1,30	55,81	11,93	-	1352	1555					
		0868				12	1000	868	2273	1170	1,30	60,50	13,00	-	1462	1681					
		11162				1100	0288	XXXX	YYYY	-0000	4	1100	288	1074	559	1,28	24,35	4,69	-	626	720
							0360				5	1100	360	1284	661	1,30	30,36	5,83	-	744	856
							0433				6	1100	433	1485	764	1,30	35,59	7,07	-	860	989
0505	7		1100	505	1673		861				1,30	40,76	8,31	-	977	1124					
0578	8		1100	578	1855		955				1,30	45,98	9,55	-	1094	1258					
0650	9		1100	650	2025		1042				1,30	51,15	10,78	-	1211	1393					
0723	10		1100	723	2191		1128				1,30	56,31	11,96	-	1328	1527					
0795	11		1100	795	2347		1208				1,30	61,39	13,12	-	1445	1662					
0868	12		1100	868	2500		1287				1,30	66,55	14,30	-	1561	1795					
11162	1200		0288	XXXX	YYYY		-0000				4	1200	288	1171	609	1,28	26,57	5,11	-	662	761
			0360								5	1200	360	1400	721	1,30	33,12	6,36	-	787	905
			0433								6	1200	433	1620	834	1,30	38,82	7,72	-	913	1050
		0505	7			1200		505	1825	939	1,30	44,46	9,06	-	1037	1193					
		0578	8			1200		578	2023	1041	1,30	50,16	10,42	-	1162	1336					
		0650	9			1200		650	2209	1137	1,30	55,80	11,76	-	1288	1481					
		0723	10			1200		723	2390	1230	1,30	61,43	13,04	-	1412	1624					
		0795	11			1200		795	2561	1318	1,30	66,97	14,32	-	1537	1768					
		0868	12			1200		868	2728	1404	1,30	72,60	15,60	-	1662	1911					
		11162	1400			0288		XXXX	YYYY	-0000	4	1400	288	1366	710	1,28	31,00	5,96	-	734	844
						0360					5	1400	360	1634	841	1,30	38,64	7,42	-	876	1007
						0433					6	1400	433	1890	973	1,30	45,29	9,00	-	1016	1168
0505	7			1400	505	2129	1096				1,30	51,87	10,57	-	1157	1331					
0578	8			1400	578	2360	1215				1,30	58,52	12,15	-	1298	1493					
0650	9			1400	650	2577	1327				1,30	65,10	13,72	-	1439	1655					
0723	10			1400	723	2789	1436				1,30	71,67	15,22	-	1580	1817					
0795	11			1400	795	2988	1538				1,30	78,13	16,70	-	1721	1979					
0868	12			1400	868	3182	1638				1,30	84,70	18,20	-	1862	2141					
11162	1600			0288	XXXX	YYYY	-0000				4	1600	288	1562	812	1,28	35,42	6,82	-	805	926
				0360							5	1600	360	1867	961	1,30	44,16	8,48	-	963	1107
				0433							6	1600	433	2160	1112	1,30	51,76	10,29	-	1120	1288
		0505	7	1600				505	2434	1253	1,30	59,28	12,08	-	1277	1469					
		0578	8	1600				578	2698	1389	1,30	66,88	13,89	-	1434	1649					
		0650	9	1600				650	2946	1516	1,30	74,40	15,68	-	1591	1830					
		0723	10	1600				723	3187	1641	1,30	81,90	17,39	-	1748	2010					
		0795	11	1600				795	3414	1757	1,30	89,30	19,09	-	1906	2192					
		0868	12	1600				868	3637	1872	1,30	96,80	20,80	-	2062	2371					

CE 05 conform EN442-1: radiatoren en convectoren

Voor de warmteafgiftes van andere regimes, kijkt u op p. 308 (correctiefactoren)  
Prijzen in euro (excl. BTW)

# VIOLA HORIZONTAAL (H2L2-RO)

## HOE VIOLA HORIZONTAAL BESTELLEN

Leveringstermijn 15 - 30 werkdagen  
(zonder transportduur)



H2L2-RO

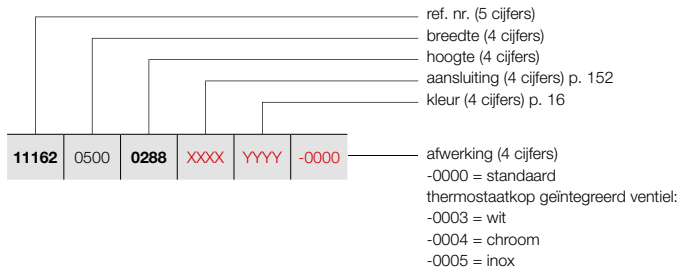

BESTELCODE MAATWERK VIOLA HORIZONTAAL						TECHNISCHE GEGEVENS						STANDAARDKLEUR	ANDERE KLEUREN								
						buizen	breedte (L mm)	hoogte (H mm)	75/65/20 (Watt)	55/45/20 (Watt)	n-exp.	gewicht (kg)	inhoud (l)	el. weerst. (Watt)	prijs RAL 9016	prijs kleur					
REF. NR. VIOLA HORIZONTAAL H2L2-RO : 11162																					
11162	1800	0288	XXXX	YYYY	-0000	4	1800	288	1757	914	1,28	39,85	7,67	-	878	1010					
		0360				5	1800	360	2101	1081	1,30	49,68	9,54	-	1051	1209					
		0433				6	1800	433	2430	1251	1,30	58,23	11,57	-	1224	1408					
		0505				7	1800	505	2738	1409	1,30	66,69	13,59	-	1397	1607					
		0578				8	1800	578	3035	1562	1,30	75,24	15,62	-	1570	1806					
		0650				9	1800	650	3314	1706	1,30	83,70	17,64	-	1744	2006					
		0723				10	1800	723	3586	1846	1,30	92,14	19,57	-	1917	2205					
		0795				11	1800	795	3841	1977	1,30	100,46	21,47	-	2090	2404					
		0868				12	1800	868	4091	2106	1,30	108,90	23,40	-	2263	2602					
		11162				2000	0288	XXXX	YYYY	-0000	4	2000	288	1952	1015	1,28	44,28	8,52	-	950	1093
							0360				5	2000	360	2334	1201	1,30	55,20	10,60	-	1138	1309
							0433				6	2000	433	2700	1390	1,30	64,70	12,86	-	1328	1527
0505	7		2000	505	3042		1566				1,30	74,10	15,10	-	1517	1745					
0578	8		2000	578	3372		1736				1,30	83,60	17,36	-	1706	1962					
0650	9		2000	650	3682		1895				1,30	93,00	19,60	-	1895	2179					
0723	10		2000	723	3984		2051				1,30	102,38	21,74	-	2085	2398					
0795	11		2000	795	4268		2197				1,30	111,62	23,86	-	2274	2615					
0868	12		2000	868	4546		2340				1,30	121,00	26,00	-	2463	2832					
11162	2200		0288	XXXX	YYYY		-0000				4	2200	288	2147	1117	1,28	48,71	9,37	-	1021	1174
			0360								5	2200	360	2567	1321	1,30	60,72	11,66	-	1227	1411
			0433								6	2200	433	2970	1529	1,30	71,17	14,15	-	1432	1647
		0505	7			2200		505	3346	1722	1,30	81,51	16,61	-	1637	1883					
		0578	8			2200		578	3709	1909	1,30	91,96	19,10	-	1842	2118					
		0650	9			2200		650	4050	2085	1,30	102,30	21,56	-	2048	2355					
		0723	10			2200		723	4382	2256	1,30	112,62	23,91	-	2253	2591					
		0795	11			2200		795	4695	2417	1,30	122,78	26,25	-	2458	2827					
		0868	12			2200		868	5001	2574	1,30	133,10	28,60	-	2664	3064					
		11162	2400			0288		XXXX	YYYY	-0000	4	2400	288	2342	1218	1,28	53,14	10,22	-	1093	1257
						0360					5	2400	360	2801	1442	1,30	66,24	12,72	-	1314	1511
						0433					6	2400	433	3240	1668	1,30	77,64	15,43	-	1536	1766
0505	7			2400	505	3650	1879				1,30	88,92	18,12	-	1757	2021					
0578	8			2400	578	4046	2083				1,30	100,32	20,83	-	1979	2276					
0650	9			2400	650	4418	2274				1,30	111,60	23,52	-	2199	2529					
0723	10			2400	723	4781	2461				1,30	122,86	26,09	-	2421	2784					
0795	11			2400	795	5122	2637				1,30	133,94	28,63	-	2642	3038					
0868	12			2400	868	5455	2808				1,30	145,20	31,20	-	2863	3292					
11162	2600			0288	XXXX	YYYY	-0000				4	2600	288	2538	1320	1,28	57,56	11,08	-	1165	1340
				0360							5	2600	360	3034	1562	1,30	71,76	13,78	-	1402	1612
				0433							6	2600	433	3510	1807	1,30	84,11	16,72	-	1640	1886
		0505	7	2600				505	3955	2036	1,30	96,33	19,63	-	1877	2159					
		0578	8	2600				578	4384	2257	1,30	108,68	22,57	-	2115	2432					
		0650	9	2600				650	4787	2464	1,30	120,90	25,48	-	2351	2704					
		0723	10	2600				723	5179	2666	1,30	133,09	28,26	-	2589	2977					
		0795	11	2600				795	5548	2856	1,30	145,11	31,02	-	2826	3250					
		0868	12	2600				868	5910	3042	1,30	157,30	33,80	-	3064	3524					

CE 05 conform EN442-1: radiatoren en convectoren

Voor de warmteafgifte van andere regimes, kijkt u op p. 308 (correctiefactoren)  
 Prijzen in euro (excl. BTW)

## HOE VIOLA HORIZONTAAL BESTELLEN

Leveringstermijn 15 - 30 werkdagen  
(zonder transportduur)

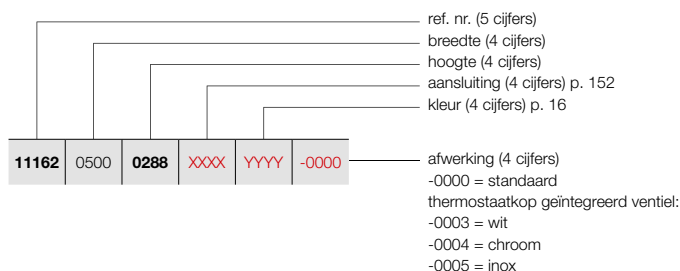

## VIOLA HORIZONTAAL (H2L2-RO)







H2L2-RO



BESTELCODE MAATWERK VIOLA HORIZONTAAL	TECHNISCHE GEGEVENS									STANDAARDKLEUR	ANDERE KLEUREN					
	buizen	breedte (L mm)	hoogte (H mm)	75/65/20 (Watt)	55/45/20 (Watt)	n-exp.	gewicht (kg)	inhoud (l)	el. weerst. (Watt)	prijs RAL 9016	prijs kleur					
REF. NR. VIOLA HORIZONTAAL H2L2-RO : 11162																
11162	2800	0288	XXXX	YYYY	-0000	4	2800	288	2733	1421	1,28	61,99	11,93	-	1236	1421
		0360				5	2800	360	3268	1682	1,30	77,28	14,84	-	1489	1712
		0433				6	2800	433	3780	1946	1,30	90,58	18,00	-	1743	2004
		0505				7	2800	505	4259	2192	1,30	103,74	21,14	-	1997	2297
		0578				8	2800	578	4721	2430	1,30	117,04	24,30	-	2251	2589
		0650				9	2800	650	5155	2654	1,30	130,20	27,44	-	2504	2880
		0723				10	2800	723	5578	2871	1,30	143,33	30,44	-	2757	3171
		0795				11	2800	795	5975	3076	1,30	156,27	33,40	-	3011	3463
11162	3000	0288	XXXX	YYYY	-0000	4	3000	288	2928	1523	1,28	66,42	12,78	-	1308	1504
		0360				5	3000	360	3501	1802	1,30	82,80	15,90	-	1578	1815
		0433				6	3000	433	4050	2085	1,30	97,05	19,29	-	1847	2124
		0505				7	3000	505	4563	2349	1,30	111,15	22,65	-	2117	2435
		0578				8	3000	578	5058	2604	1,30	125,40	26,04	-	2387	2745
		0650				9	3000	650	5523	2843	1,30	139,50	29,40	-	2655	3053
		0723				10	3000	723	5976	3076	1,30	153,57	32,61	-	2925	3364

CE 05 conform EN442-1: radiatoren en convectoren

Voor de warmteafgiftes van andere regimes, kijkt u op p. 308 (correctiefactoren)  
Prijzen in euro (excl. BTW)

**VIOLA** VRIJSTAANDE OPSTELLING  
IN OPTIE

VRIJSTAANDE OPSTELLING	BREEDTE RADIATOR	KLEUR	ART. NR.	€
 <p>TELESCOPISCHE VOET + TELESCOPISCHE ZIJBEVESTIGING</p> 	<b>H2-RO / H2L1-RO</b>			
	≤ 2400 mm (2 voeten, 1 zijbevestiging)	RAL 9016	*	<b>90</b>
		KLEUR	*	<b>103</b>
	≥ 2600 mm (3 voeten, 1 zijbevestiging)	RAL 9016	*	<b>119</b>
		KLEUR	*	<b>137</b>
	<b>V2-ZB</b>			
(2 voeten, 1 zijbevestiging) of (1 voet, 2 zijbevestigingen)	RAL 9016	*	<b>90</b>	
	KLEUR	*	<b>103</b>	
<ul style="list-style-type: none"> <li>• Opgelet: voeten dienen tesamen met de radiator besteld te worden.</li> <li>V2-ZB: 2 voeten; H2-RO/H2L1-RO: L 500-2400 mm: 2 voeten; 2600-3000 mm: 3 voeten</li> <li>* Viola Horizontaal (voet(en) + 1 zijbevestiging): Gelieve bij bestelling <b>code -0001</b> aan te geven bij "Afwerking".</li> <li>* Viola Verticaal (1 voet + 2 zijbevestigingen): Gelieve bij bestelling <b>code -0008</b> aan te geven bij "Afwerking".</li> <li>* Viola Verticaal (2 voeten + 1 zijbevestiging): Gelieve bij bestelling <b>code -0009</b> aan te geven bij "Afwerking".</li> </ul>				
 <p>TELESCOPISCHE VOET + STANDAARD MUURBEVESTIGING</p> 	<b>H2-RO / H2L1-RO</b>			
	≤ 2400 mm (2 voeten)	RAL 9016	*	<b>60</b>
		KLEUR	*	<b>69</b>
	≥ 2600 mm (3 voeten)	RAL 9016	*	<b>90</b>
		KLEUR	*	<b>103</b>
	<b>V2-ZB</b>			
(2 voeten)	RAL 9016	*	<b>60</b>	
	KLEUR	*	<b>69</b>	
<ul style="list-style-type: none"> <li>• Opgelet: voeten dienen tesamen met de radiator besteld te worden.</li> <li>V2-ZB: 2 voeten; H2-RO/H2L1-RO: L 500-2400 mm: 2 voeten; 2600-3000 mm: 3 voeten</li> <li>* Gelieve bij bestelling <b>code -0007</b> aan te geven bij "Afwerking".</li> </ul>				

ACCESSOIRES	KLEUR	ART. NR.	€
<b>HANDDOEKBEUGEL</b> 	<b>V1-ZB / V1L1-ZB / V2-ZB</b> <b>H1-RO / H1L1-RO / H2-RO / H2L1-RO / H2L2-RO</b>		
	CHROOM	118322300000099	<b>166</b>
<ul style="list-style-type: none"> <li>h = 22 mm; b = 670 mm; d = 85 mm; a = 60 mm</li> </ul>			
<b>KNOP O-RING</b> 	<b>V1-ZB / V1L1-ZB / V2-ZB</b> <b>H1-RO / H1L1-RO / H2-RO / H2L1-RO / H2L2-RO</b>		
	CHROOM	118360000000099	<b>28</b>
<ul style="list-style-type: none"> <li>h = 22 mm; b = 22 mm; d = 42 mm</li> </ul>			
<b>KNOP BREDE GLEUF</b> 	<b>V1-ZB / V1L1-ZB / V2-ZB</b> <b>H1-RO / H1L1-RO / H2-RO / H2L1-RO / H2L2-RO</b>		
	CHROOM	118340000000099	<b>28</b>
<ul style="list-style-type: none"> <li>h = 22 mm; b = 22 mm; d = 42 mm</li> </ul>			
<b>DROOG- EN STAPELREK SMAL</b> 	<b>V1-ZB / V1L1-ZB / V2-ZB</b> <b>H1-RO / H1L1-RO / H2-RO / H2L1-RO / H2L2-RO</b>		
	CHROOM	118300700000099	<b>166</b>
<ul style="list-style-type: none"> <li>h = 22 mm; b = 385 mm; d = 163 mm; a = 30 mm</li> </ul>			
<b>DROOG- EN STAPELREK BREED</b> 	<b>V1-ZB / V1L1-ZB / V2-ZB</b> <b>H1-RO / H1L1-RO / H2-RO / H2L1-RO / H2L2-RO</b>		
	CHROOM	118301000000099	<b>166</b>
<ul style="list-style-type: none"> <li>h = 22 mm; b = 530 mm; d = 163 mm; a = 30 mm</li> </ul>			

d = afstand voorkant accessoire tot voorkant radiator  
a = afstand accessoire tot radiator  
**uit voorraad leverbaar**

**VIOLA VERTICAAL: V1-ZB / V1L1-ZB / V2-ZB (VOORRAAD)**

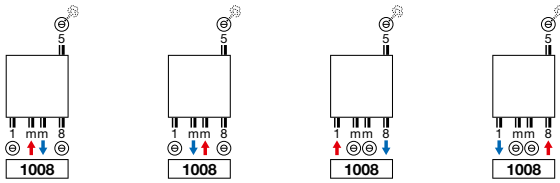

**VIOLA HORIZONTAAL: H1-RO / H1L1-RO / H2-RO / H2L1-RO / H2L2-RO**

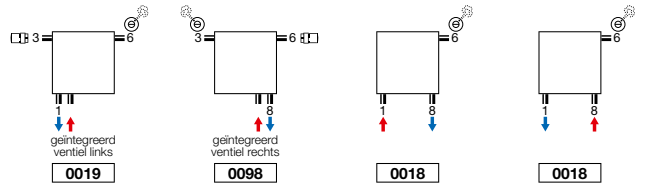

- mm aansluiting alleen mogelijk bij even aantal buizen.

**VIOLA VERTICAAL: V1-ZB / V1L1-ZB / V2-ZB (NIET-VOORRAAD)**

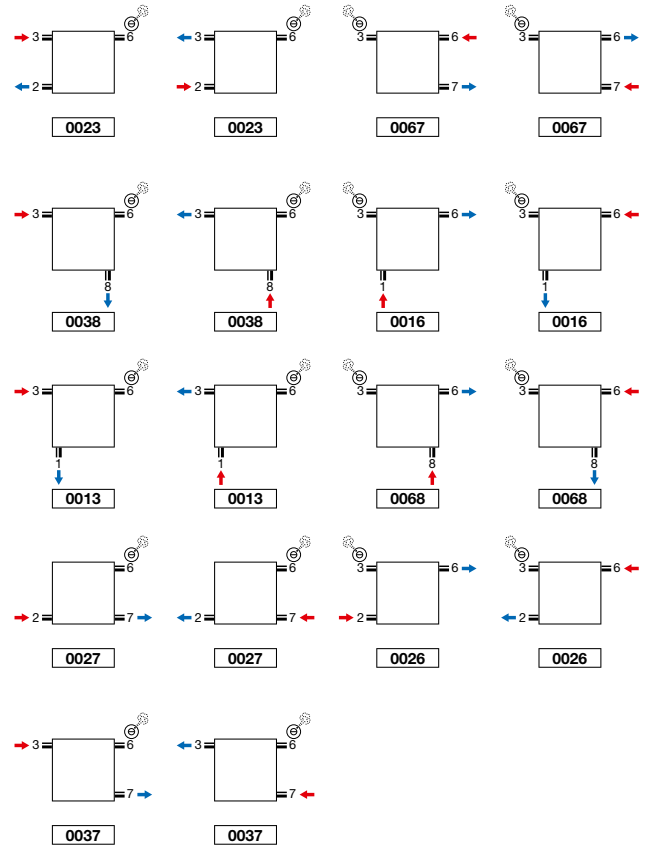
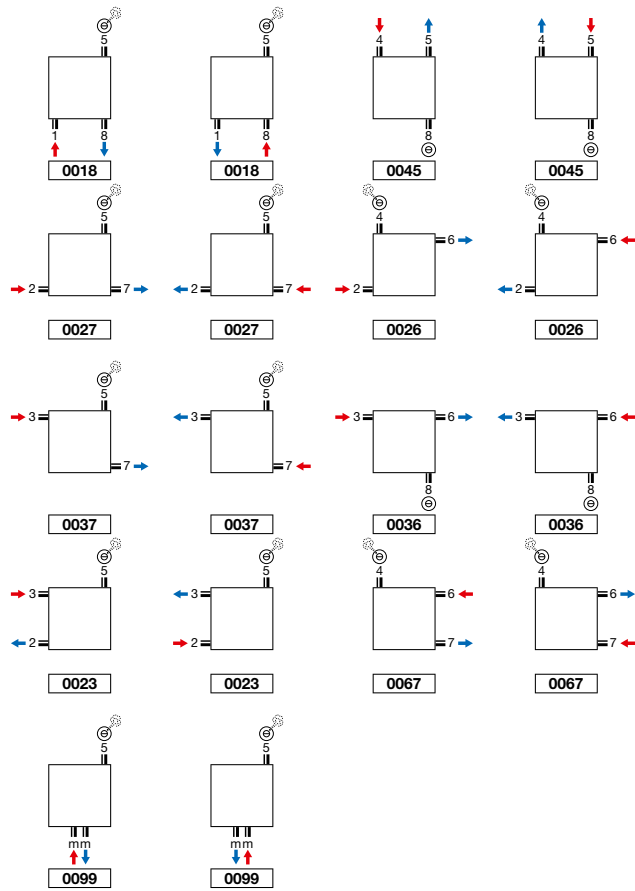

- Geïntegreerd ventiel: meerprijs €102 (zie p. 302)

**Opmerking:** het aansluiten van de radiator kan enkel volgens de getoonde aansluiticonen. Voor elke andere aansluitwijze nemen wij geen verantwoordelijkheid.

VIOLA VERTICAAL (V1-ZB, V1L1-ZB, V2-ZB)

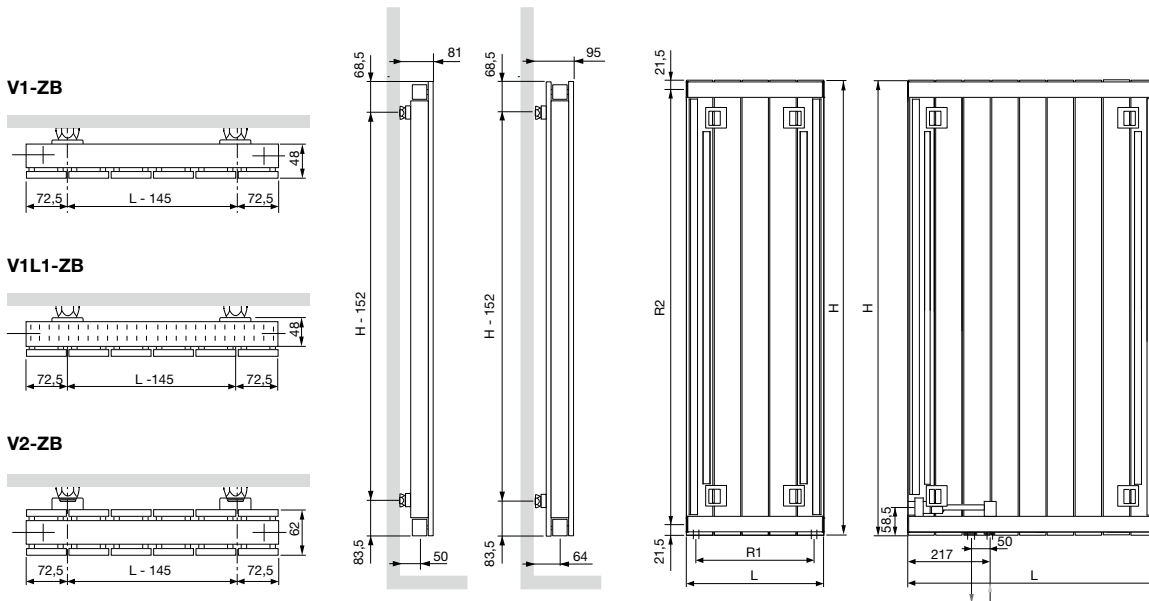

	V1-ZB / V2-ZB / V1L1-ZB													
Aantal buizen	3	4	5	6	7	8	9	10	11	12	14			
Breedte (L)	215	288	360	433	505	578	650	723	795	868	1013			
Hartafstand tussen de onderaansluitingen 18 (R1)	165	238	310	383	455	528	600	673	745	818	963			
Hoogte (H)	600	1200	1400	1600	1800	2000	2200	2400						
Hartafstand tussen de zijaansluitingen 23/67 (R2)	557	1157	1357	1557	1757	1957	2157	2357						
Hartafstand tussen de ophangingen	L-145	H-152												

VIOLA VERTICAAL (V2-ZB) VRIJSTAANDE OPSTELLING

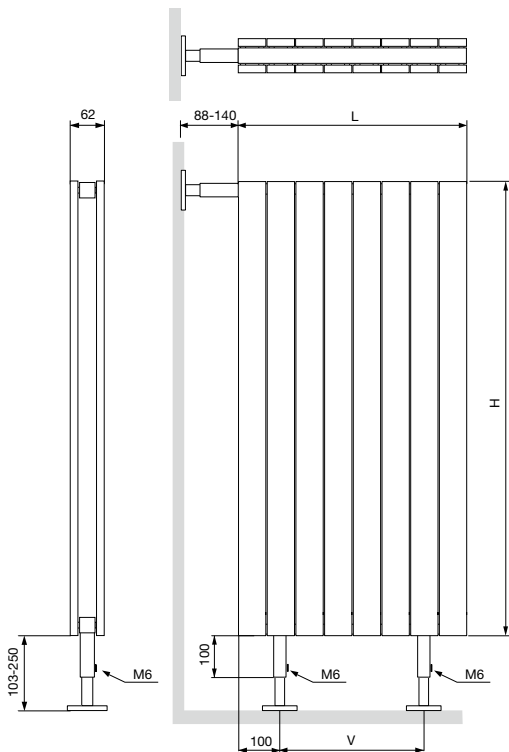

	VRIJSTAAND V2-ZB													
Breedte (L)	215	288	360	433	505	578	650	723	795	868	1013			
Hartafstand tussen de voeten (V)	15	88	160	233	305	378	450	523	595	668	813			



VIOLA HORIZONTAAL (H1-RO, H1L1-RO, H2-RO, H2L1-RO, H2L2-RO)

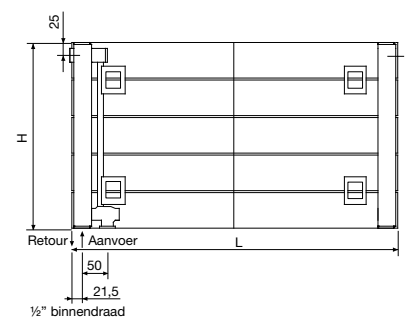
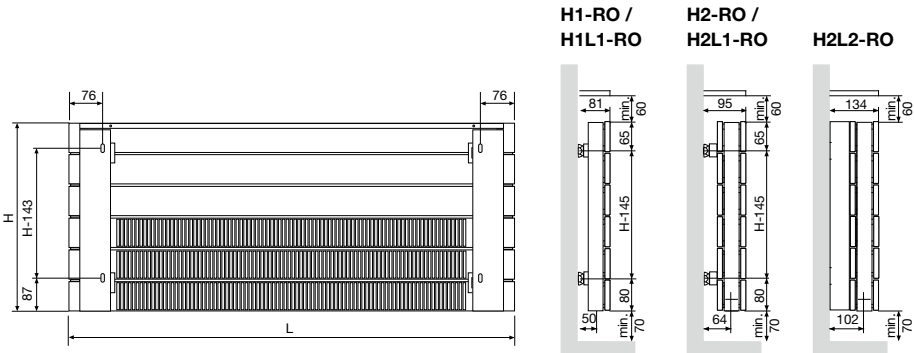
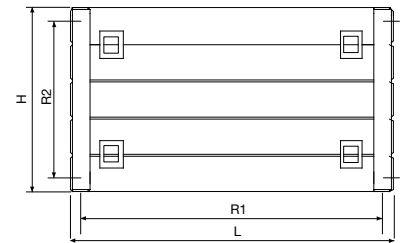
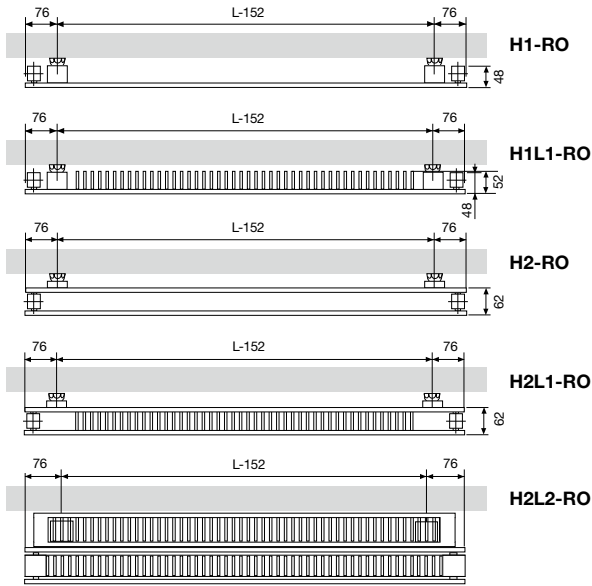

	H1-RO / H1L1-RO / H2-RO / H2L1-RO / H2L2-RO																
Breedte (L)	500	600	700	800	900	1000	1100	1200	1400	1600	1800	2000	2200	2400	2600	2800	3000
Hartafstand tussen de onderaansluitingen 18 (R1)	457	557	657	757	857	957	1057	1157	1357	1557	1757	1957	2157	2357	2557	2757	2957
Hoogte (H)	288	360	433	505	578	650	723	795	868								
Hartafstand tussen de zijansluitingen 23/67 (R2)	238	310	383	455	528	600	673	745	818								
Hartafstand tussen de ophangingen	L-152	H-145															
Hartafstand tussen de ophangingen (H2L2-RO)	H-143																

VIOLA HORIZONTAAL (H2-RO, H2L1-RO) VRIJSTAANDE OPSTELLING

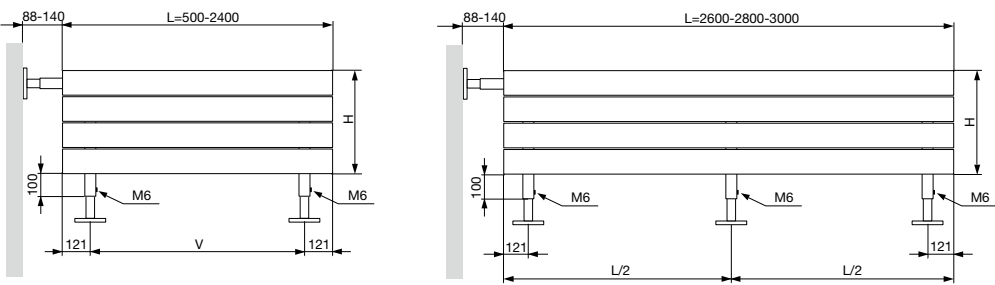

	VRIJSTAANDE H2-RO / H2L1-RO																
Breedte (L)	500	600	700	800	900	1000	1100	1200	1400	2600	2800	3000					
Hartafstand tussen de voeten (V)	258	358	458	558	658	758	858	958	1158	777	827	877					

**TYPES**

- Eén (TV1) of twee rijen buizen (TV2)

**BUIZEN**

- Verticaal, platovaal 57,5 x 10 mm

**COLLECTOREN**

- Horizontaal, achterliggend, rond Ø 35 mm

**KLEUREN**

- Standaardkleur wit RAL 9016
- Niet verkrijgbaar in kleur Gloss White
- Uitgebreide kleurenkaart zie p. 16

**SPECIAAL**

- Tulipa 6 en 8 buizen: aansluiting 1mm8, 18, 81 niet mogelijk

**BEVESTIGINGEN**

- Muurbevestigingen standaard
- TV1 / TV2 ook verkrijgbaar als vrijstaande opstelling, zie p. 169
- Bij vrijstaande opstelling de K-maat (afstand vloer / radiator) en B-maat (afstand radiator / plafond) opgeven.

**TECHNISCH**

- Weerstandsgelast (onzichtbare lasnaden)
- KTL-grondlaag, poedercoating
- Standaardwerkdruk: 4 bar. Meerprijs hogere werkdruk (10 bar): +10%.
- De leveringstermijn van radiator met een hogere werkdruk is 1 week extra.
- Maximale bedrijfstemperatuur: 110°C

**ELEKTRISCH** (zie hoofdstuk elektrische radiatoren)

- ✗ Zuiver elektrische radiator in de fabriek vorgevuld
- ✗ Gemengde radiator

**TECHNISCHE TEKENINGEN**

- Zie p. 172

**AANSLUITING**

- ✓ Eénpuntsaansluiting voor éénpijpsysteem (radiator speciaal te bestellen) (zie p. 301)
- ✓ Eénpuntsaansluiting voor tweepijpsysteem (radiator speciaal te bestellen) (zie p. 301)
- ✓ Tweepuntsaansluiting voor éénpijpsysteem (aansluiting via de middenaansluiting) (zie p. 300)
- ✓ Tweepuntsaansluiting voor tweepijpsysteem (standaard) (zie p. 300)
- ✗ Geïntegreerd ventiel

**AANBEVOLEN AANSLUITING (1008)**

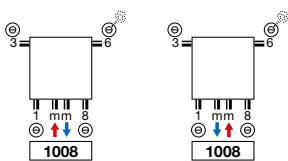

Andere aansluitmogelijkheden, zie p. 171



art. nr. 118200200009016  
**prijs € 91**  
 Koppelingen, zie p. 313

**AANBEVOLEN VOOR BADKAMER IN OPTIE**



handdoekbeugel (chroom)  
 art. nr. 11832220000099  
**prijs € 166**

Andere accessoires, zie p. 170



**OVER TULIPA VERTICAAL**

**Warmte in alle openheid**

Een designradiator van de eerste generatie. Geschikt voor alle ruimten en toepassingen. De open structuur en de loodrechte aansluiting van de buizen op de collector leverde Vasco ooit een officieel hygiëncertificaat op. De waarborg voor een smetteloos verwarmingscomfort waar dan ook in huis.

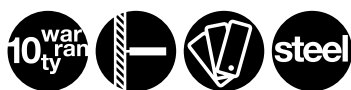

TV1 / TV2

# TULIPA VERTICAAL (TV1)



TV1

## HOE TULIPA VERTICAAL BESTELLEN

Leveringstermijn 15 - 30 werkdagen  
(zonder transportduur)

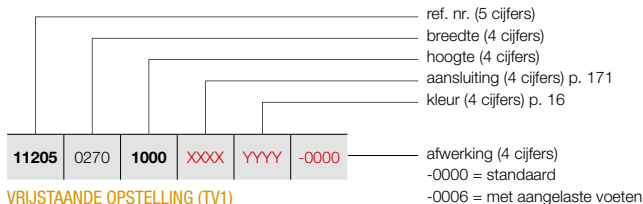

## VRIJSTAANDE OPSTELLING (TV1)

Zie p. 169 voor extra toebehoren.

## HOE VOORRAADRADIATOR TULIPA VERTICAAL BESTELLEN

Leveringstermijn 5 werkdagen  
(zonder transportduur)

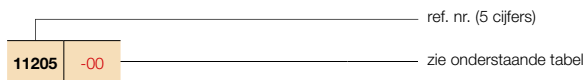

BESTELCODE MAATWERK TULIPA VERTICAAL							TECHNISCHE GEGEVENS					STANDAARDKLEUR		ANDERE KLEUREN			
buizen	breedte (L mm)	hoogte (H mm)	75/65/20 (Watt)	55/45/20 (Watt)	n-exp.	gewicht (kg)	inhoud (l)	el. weerst. (Watt)	prijs RAL 9016	verkorte ref. nr. RAL 9016 voorraad	prijs kleur						
<b>REF. NR. TULIPA VERTICAAL TV1 : 11205</b>																	
<b>11205</b>	<b>0270</b>	<b>1000</b>	<b>XXXX</b>	<b>YYYY</b>	<b>-0000</b>	6	270	1000	357	187	1,27	9,30	2,64	-	<b>180</b>	-	<b>207</b>
		<b>1200</b>				6	270	1200	422	218	1,29	10,98	3,00	-	<b>199</b>	-	<b>229</b>
		<b>1400</b>				6	270	1400	488	250	1,31	12,66	3,42	-	<b>216</b>	-	<b>248</b>
		<b>1600</b>				6	270	1600	557	282	1,33	14,04	3,78	-	<b>234</b>	-	<b>269</b>
		<b>1800</b>				6	270	1800	627	319	1,32	15,78	4,32	-	<b>251</b>	-	<b>289</b>
		<b>2000</b>				6	270	2000	700	358	1,31	17,52	4,80	-	<b>270</b>	-	<b>311</b>
		<b>2200</b>				6	270	2200	775	401	1,29	19,20	5,34	-	<b>287</b>	-	<b>330</b>
		<b>2400</b>				6	270	2400	848	439	1,29	20,94	5,82	-	<b>305</b>	-	<b>351</b>
		<b>2600</b>				6	270	2600	921	477	1,29	22,68	6,30	-	<b>322</b>	-	<b>370</b>
		<b>2800</b>				6	270	2800	994	514	1,29	24,42	6,84	-	<b>340</b>	-	<b>391</b>
		<b>3000</b>				6	270	3000	1067	552	1,29	26,16	7,32	-	<b>358</b>	-	<b>412</b>
<b>11205</b>	<b>0360</b>	<b>1000</b>	<b>XXXX</b>	<b>YYYY</b>	<b>-0000</b>	8	360	1000	476	249	1,27	12,40	3,52	-	<b>224</b>	-	<b>258</b>
		<b>1200</b>				8	360	1200	563	291	1,29	14,64	4,00	-	<b>247</b>	-	<b>284</b>
		<b>1400</b>				8	360	1400	651	333	1,31	16,88	4,56	-	<b>271</b>	-	<b>312</b>
		<b>1600</b>				8	360	1600	742	376	1,33	18,72	5,04	-	<b>295</b>	-	<b>339</b>
		<b>1800</b>				8	360	1800	836	426	1,32	21,04	5,76	-	<b>318</b>	-	<b>366</b>
		<b>2000</b>				8	360	2000	933	478	1,31	23,36	6,40	-	<b>342</b>	-	<b>393</b>
		<b>2200</b>				8	360	2200	1034	535	1,29	25,60	7,12	-	<b>365</b>	-	<b>420</b>
		<b>2400</b>				8	360	2400	1131	585	1,29	27,92	7,76	-	<b>388</b>	-	<b>446</b>
		<b>2600</b>				8	360	2600	1228	635	1,29	30,24	8,40	-	<b>412</b>	-	<b>474</b>
		<b>2800</b>				8	360	2800	1325	686	1,29	32,56	9,12	-	<b>436</b>	-	<b>501</b>
		<b>3000</b>				8	360	3000	1422	736	1,29	34,88	9,76	-	<b>459</b>	-	<b>528</b>
<b>11205</b>	<b>0450</b>	<b>1000</b>	<b>XXXX</b>	<b>YYYY</b>	<b>-0000</b>	10	450	1000	596	312	1,27	15,50	4,40	-	<b>266</b>	-	<b>306</b>
		<b>1200</b>				10	450	1200	704	364	1,29	18,30	5,00	-	<b>296</b>	-	<b>340</b>
		<b>1400</b>				10	450	1400	814	417	1,31	21,10	5,70	-	<b>324</b>	-	<b>373</b>
		<b>1600</b>				10	450	1600	928	470	1,33	23,40	6,30	-	<b>354</b>	-	<b>407</b>
		<b>1800</b>				10	450	1800	1045	532	1,32	26,30	7,20	-	<b>384</b>	<b>11205-01</b>	<b>442</b>
		<b>2000</b>				10	450	2000	1166	597	1,31	29,20	8,00	-	<b>413</b>	<b>11205-02</b>	<b>475</b>
		<b>2200</b>				10	450	2200	1292	668	1,29	32,00	8,90	-	<b>443</b>	-	<b>509</b>
		<b>2400</b>				10	450	2400	1413	731	1,29	34,90	9,70	-	<b>473</b>	-	<b>544</b>
		<b>2600</b>				10	450	2600	1535	794	1,29	37,80	10,50	-	<b>503</b>	-	<b>578</b>
		<b>2800</b>				10	450	2800	1656	857	1,29	40,70	11,40	-	<b>531</b>	-	<b>611</b>
		<b>3000</b>				10	450	3000	1778	920	1,29	43,60	12,20	-	<b>561</b>	-	<b>645</b>
<b>11205</b>	<b>0540</b>	<b>1000</b>	<b>XXXX</b>	<b>YYYY</b>	<b>-0000</b>	12	540	1000	715	374	1,27	18,60	5,28	-	<b>308</b>	-	<b>354</b>
		<b>1200</b>				12	540	1200	844	437	1,29	21,96	6,00	-	<b>344</b>	-	<b>396</b>
		<b>1400</b>				12	540	1400	977	500	1,31	25,32	6,84	-	<b>379</b>	-	<b>436</b>
		<b>1600</b>				12	540	1600	1113	564	1,33	28,08	7,56	-	<b>415</b>	-	<b>477</b>
		<b>1800</b>				12	540	1800	1254	639	1,32	31,56	8,64	-	<b>450</b>	<b>11205-07</b>	<b>518</b>
		<b>2000</b>				12	540	2000	1399	716	1,31	35,04	9,60	-	<b>485</b>	<b>11205-03</b>	<b>558</b>
		<b>2200</b>				12	540	2200	1550	802	1,29	38,40	10,68	-	<b>521</b>	-	<b>599</b>
		<b>2400</b>				12	540	2400	1696	877	1,29	41,88	11,64	-	<b>556</b>	-	<b>639</b>
		<b>2600</b>				12	540	2600	1842	953	1,29	45,36	12,60	-	<b>592</b>	-	<b>681</b>
		<b>2800</b>				12	540	2800	1988	1029	1,29	48,84	13,68	-	<b>627</b>	-	<b>721</b>
		<b>3000</b>				12	540	3000	2133	1104	1,29	52,32	14,64	-	<b>663</b>	-	<b>762</b>

CE 05 conform EN442-1: radiatoren en convectoren

Voor de warmteafgifte van andere regimes, kijkt u op p. 308 (correctiefactoren)  
Prijzen in euro (excl. BTW)

## HOE TULIPA VERTICAAL BESTELLEN

Leveringstermijn 15 - 30 werkdagen  
(zonder transportduur)

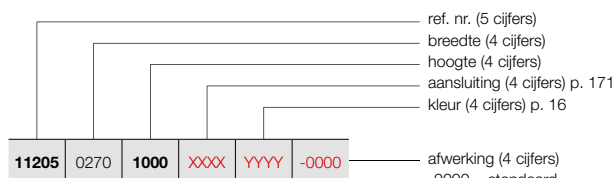

### VRIJSTAANDE OPSTELLING (TV1)

Zie p. 169 voor extra toebehoren.

### HOE VOORRAADRADIATOR TULIPA VERTICAAL BESTELLEN

Leveringstermijn 5 werkdagen  
(zonder transportduur)

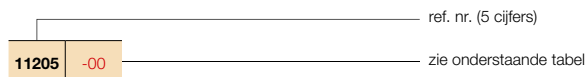

## TULIPA VERTICAAL (TV1)

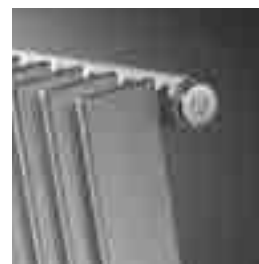

TV1

BESTELCODE MAATWERK TULIPA VERTICAAL	TECHNISCHE GEGEVENS									STANDAARDKLEUR		ANDERE KLEUREN					
	buizen	breedte (L mm)	hoogte (H mm)	75/65/20 (Watt)	55/45/20 (Watt)	n-exp.	gewicht (kg)	inhoud (l)	el. weerst. (Watt)	prijs RAL 9016	verkorte ref. nr. RAL 9016 voorraad	prijs kleur					
<b>REF. NR. TULIPA VERTICAAL TV1 : 11205</b>																	
<b>11205</b>	<b>0630</b>	<b>1000</b>	<b>XXXX</b>	<b>YYYY</b>	<b>-0000</b>	14	630	1000	834	436	1,27	21,70	6,16	-	<b>351</b>	-	<b>404</b>
		<b>1200</b>				14	630	1200	985	510	1,29	25,62	7,00	-	<b>392</b>	-	<b>451</b>
		<b>1400</b>				14	630	1400	1139	583	1,31	29,54	7,98	-	<b>434</b>	-	<b>499</b>
		<b>1600</b>				14	630	1600	1299	658	1,33	32,76	8,82	-	<b>475</b>	-	<b>546</b>
		<b>1800</b>				14	630	1800	1463	745	1,32	36,82	10,08	-	<b>516</b>	<b>11205-08</b>	<b>593</b>
		<b>2000</b>				14	630	2000	1633	836	1,31	40,88	11,20	-	<b>557</b>	<b>11205-09</b>	<b>641</b>
		<b>2200</b>				14	630	2200	1809	936	1,29	44,80	12,46	-	<b>599</b>	-	<b>689</b>
		<b>2400</b>				14	630	2400	1979	1024	1,29	48,86	13,58	-	<b>641</b>	-	<b>737</b>
		<b>2600</b>				14	630	2600	2149	1112	1,29	52,92	14,70	-	<b>682</b>	-	<b>784</b>
		<b>2800</b>				14	630	2800	2319	1200	1,29	56,98	15,96	-	<b>723</b>	-	<b>831</b>
		<b>3000</b>				14	630	3000	2489	1288	1,29	61,04	17,08	-	<b>764</b>	-	<b>879</b>
<b>11205</b>	<b>0720</b>	<b>1000</b>	<b>XXXX</b>	<b>YYYY</b>	<b>-0000</b>	16	720	1000	953	498	1,27	24,80	7,04	-	<b>393</b>	-	<b>452</b>
		<b>1200</b>				16	720	1200	1126	583	1,29	29,28	8,00	-	<b>441</b>	-	<b>507</b>
		<b>1400</b>				16	720	1400	1302	667	1,31	33,76	9,12	-	<b>488</b>	-	<b>561</b>
		<b>1600</b>				16	720	1600	1484	752	1,33	37,44	10,08	-	<b>536</b>	-	<b>616</b>
		<b>1800</b>				16	720	1800	1672	852	1,32	42,08	11,52	-	<b>582</b>	-	<b>669</b>
		<b>2000</b>				16	720	2000	1866	956	1,31	46,72	12,80	-	<b>629</b>	<b>11205-04</b>	<b>723</b>
		<b>2200</b>				16	720	2200	2067	1069	1,29	51,20	14,24	-	<b>677</b>	-	<b>779</b>
		<b>2400</b>				16	720	2400	2261	1170	1,29	55,84	15,52	-	<b>724</b>	-	<b>833</b>
		<b>2600</b>				16	720	2600	2456	1271	1,29	60,48	16,80	-	<b>771</b>	-	<b>887</b>
		<b>2800</b>				16	720	2800	2650	1371	1,29	65,12	18,24	-	<b>819</b>	-	<b>942</b>
		<b>3000</b>				16	720	3000	2844	1471	1,29	69,76	19,52	-	<b>866</b>	-	<b>996</b>
<b>11205</b>	<b>0810</b>	<b>1000</b>	<b>XXXX</b>	<b>YYYY</b>	<b>-0000</b>	18	810	1000	1072	560	1,27	27,90	7,92	-	<b>436</b>	-	<b>501</b>
		<b>1200</b>				18	810	1200	1266	655	1,29	32,94	9,00	-	<b>489</b>	-	<b>562</b>
		<b>1400</b>				18	810	1400	1465	750	1,31	37,98	10,26	-	<b>542</b>	-	<b>623</b>
		<b>1600</b>				18	810	1600	1670	847	1,33	42,12	11,34	-	<b>595</b>	-	<b>684</b>
		<b>1800</b>				18	810	1800	1881	958	1,32	47,34	12,96	-	<b>649</b>	-	<b>746</b>
		<b>2000</b>				18	810	2000	2099	1075	1,31	52,56	14,40	-	<b>701</b>	-	<b>806</b>
		<b>2200</b>				18	810	2200	2325	1203	1,29	57,60	16,02	-	<b>755</b>	-	<b>868</b>
		<b>2400</b>				18	810	2400	2544	1316	1,29	62,82	17,46	-	<b>809</b>	-	<b>930</b>
		<b>2600</b>				18	810	2600	2763	1430	1,29	68,04	18,90	-	<b>861</b>	-	<b>990</b>
		<b>2800</b>				18	810	2800	2981	1542	1,29	73,26	20,52	-	<b>915</b>	-	<b>1052</b>
		<b>3000</b>				18	810	3000	3200	1656	1,29	78,48	21,96	-	<b>968</b>	-	<b>1113</b>
<b>11205</b>	<b>0900</b>	<b>1000</b>	<b>XXXX</b>	<b>YYYY</b>	<b>-0000</b>	20	900	1000	1191	623	1,27	31,00	8,80	-	<b>478</b>	-	<b>550</b>
		<b>1200</b>				20	900	1200	1407	728	1,29	36,60	10,00	-	<b>538</b>	-	<b>619</b>
		<b>1400</b>				20	900	1400	1628	834	1,31	42,20	11,40	-	<b>596</b>	-	<b>685</b>
		<b>1600</b>				20	900	1600	1855	940	1,33	46,80	12,60	-	<b>655</b>	-	<b>753</b>
		<b>1800</b>				20	900	1800	2090	1065	1,32	52,60	14,40	-	<b>715</b>	-	<b>822</b>
		<b>2000</b>				20	900	2000	2332	1194	1,31	58,40	16,00	-	<b>774</b>	-	<b>890</b>
		<b>2200</b>				20	900	2200	2584	1337	1,29	64,00	17,80	-	<b>833</b>	-	<b>958</b>
		<b>2400</b>				20	900	2400	2827	1463	1,29	69,80	19,40	-	<b>892</b>	-	<b>1026</b>
		<b>2600</b>				20	900	2600	3070	1588	1,29	75,60	21,00	-	<b>951</b>	-	<b>1094</b>
		<b>2800</b>				20	900	2800	3313	1714	1,29	81,40	22,80	-	<b>1010</b>	-	<b>1162</b>
		<b>3000</b>				20	900	3000	3556	1840	1,29	87,20	24,40	-	<b>1069</b>	-	<b>1229</b>

CE 05 conform EN442-1: radiatoren en convectoren

Voor de warmteafgiftes van andere regimes, kijkt u op p. 308 (correctiefactoren)  
Prijzen in euro (excl. BTW)

# TULIPA VERTICAAL (TV1)



TV1

## HOE TULIPA VERTICAAL BESTELLEN

Leveringstermijn 15 - 30 werkdagen  
(zonder transportduur)

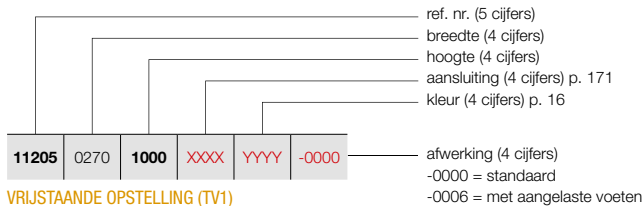

## VRIJSTAANDE OPSTELLING (TV1)

Zie p. 169 voor extra toebehoren.

BESTELCODE MAATWERK TULIPA VERTICAAL							TECHNISCHE GEGEVENS						STANDAARDKLEUR		ANDERE KLEUREN		
REF. NR.	0990	1000	XXXX	YYYY	-0000	buizen	breedte (L mm)	hoogte (H mm)	75/65/20 (Watt)	55/45/20 (Watt)	n-exp.	gewicht (kg)	inhoud (l)	el. weerst. (Watt)	prijs RAL 9016	verkorte ref. nr. RAL 9016 voorraad	prijs kleur
<b>REF. NR. TULIPA VERTICAAL TV1 : 11205</b>																	
11205	0990	1000	XXXX	YYYY	-0000	22	990	1000	1310	685	1,27	34,10	9,68	-	521	-	599
		1200				22	990	1200	1548	801	1,29	40,26	11,00	-	586	-	674
		1400				22	990	1400	1791	917	1,31	46,42	12,54	-	651	-	749
		1600				22	990	1600	2041	1035	1,33	51,48	13,86	-	716	-	823
		1800				22	990	1800	2299	1171	1,32	57,86	15,84	-	781	-	898
		2000				22	990	2000	2565	1314	1,31	64,24	17,60	-	846	-	973
		2200				22	990	2200	2842	1470	1,29	70,40	19,58	-	911	-	1048
		2400				22	990	2400	3109	1609	1,29	76,78	21,34	-	976	-	1122
		2600				22	990	2600	3377	1747	1,29	83,16	23,10	-	1041	-	1197
		2800				22	990	2800	3644	1885	1,29	89,54	25,08	-	1106	-	1272
		3000				22	990	3000	3911	2023	1,29	95,92	26,84	-	1171	-	1347
11205	1080	1000	XXXX	YYYY	-0000	24	1080	1000	1429	747	1,27	37,20	10,56	-	563	-	647
		1200				24	1080	1200	1688	873	1,29	43,92	12,00	-	634	-	729
		1400				24	1080	1400	1953	1000	1,31	50,64	13,68	-	706	-	812
		1600				24	1080	1600	2226	1128	1,33	56,16	15,12	-	776	-	892
		1800				24	1080	1800	2508	1278	1,32	63,12	17,28	-	847	-	974
		2000				24	1080	2000	2799	1433	1,31	70,08	19,20	-	918	-	1056
		2200				24	1080	2200	3101	1604	1,29	76,80	21,36	-	989	-	1137
		2400				24	1080	2400	3392	1755	1,29	83,76	23,28	-	1060	-	1219
		2600				24	1080	2600	3684	1906	1,29	90,72	25,20	-	1131	-	1301
		2800				24	1080	2800	3975	2057	1,29	97,68	27,36	-	1202	-	1382
		3000				24	1080	3000	4267	2208	1,29	104,64	29,28	-	1273	-	1464
11205	1170	1000	XXXX	YYYY	-0000	26	1170	1000	1548	809	1,27	40,30	11,44	-	606	-	697
		1200				26	1170	1200	1829	946	1,29	47,58	13,00	-	683	-	785
		1400				26	1170	1400	2116	1084	1,31	54,86	14,82	-	759	-	873
		1600				26	1170	1600	2412	1223	1,33	60,84	16,38	-	836	-	961
		1800				26	1170	1800	2716	1384	1,32	68,38	18,72	-	914	-	1051
		2000				26	1170	2000	3032	1553	1,31	75,92	20,80	-	990	-	1139
		2200				26	1170	2200	3359	1738	1,29	83,20	23,14	-	1067	-	1227
		2400				26	1170	2400	3675	1901	1,29	90,74	25,22	-	1143	-	1314
		2600				26	1170	2600	3990	2064	1,29	98,28	27,30	-	1221	-	1404
		2800				26	1170	2800	4306	2228	1,29	105,82	29,64	-	1298	-	1493
		3000				26	1170	3000	4622	2391	1,29	113,36	31,72	-	1374	-	1580
11205	1260	1000	XXXX	YYYY	-0000	28	1260	1000	1667	871	1,27	43,40	12,32	-	648	-	745
		1200				28	1260	1200	1970	1019	1,29	51,24	14,00	-	731	-	841
		1400				28	1260	1400	2279	1167	1,31	59,08	15,96	-	814	-	936
		1600				28	1260	1600	2597	1316	1,33	65,52	17,64	-	896	-	1030
		1800				28	1260	1800	2925	1490	1,32	73,64	20,16	-	980	-	1127
		2000				28	1260	2000	3265	1672	1,31	81,76	22,40	-	1062	-	1221
		2200				28	1260	2200	3617	1871	1,29	89,60	24,92	-	1144	-	1316
		2400				28	1260	2400	3958	2048	1,29	97,72	27,16	-	1228	-	1412
		2600				28	1260	2600	4297	2223	1,29	105,84	29,40	-	1310	-	1507
		2800				28	1260	2800	4638	2400	1,29	113,96	31,92	-	1394	-	1603
		3000				28	1260	3000	4978	2576	1,29	122,08	34,16	-	1476	-	1697

CE 05 conform EN442-1: radiatoren en convectoren

Voor de warmteafgiftes van andere regimes, kijkt u op p. 308 (correctiefactoren)  
Prijzen in euro (excl. BTW)

### HOE TULIPA VERTICAAL BESTELLEN

Leveringstermijn 15 - 30 werkdagen  
(zonder transportduur)

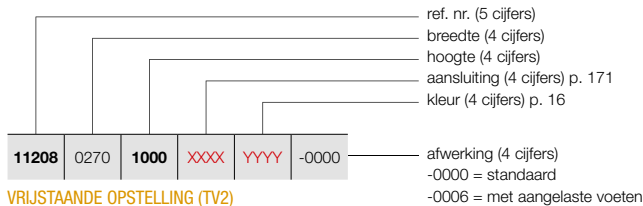

### VRIJSTAANDE OPSTELLING (TV2)

Zie p. 169 voor extra toebehoren.

### HOE VOORRAADRADIATOR TULIPA VERTICAAL BESTELLEN

Leveringstermijn 5 werkdagen  
(zonder transportduur)

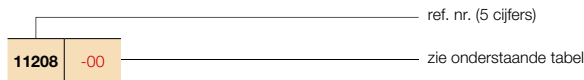

## TULIPA VERTICAAL (TV2)



TV2

BESTELCODE MAATWERK TULIPA VERTICAAL							TECHNISCHE GEGEVENS						STANDAARDKLEUR		ANDERE KLEUREN		
							buizen	breedte (L mm)	hoogte (H mm)	75/65/20 (Watt)	55/45/20 (Watt)	n-exp.	gewicht (kg)	inhoud (l)	el. weerst. (Watt)	prijs RAL 9016	verkorte ref. nr. RAL 9016 voorraad
<b>REF. NR. TULIPA VERTICAAL TV2 : 11208</b>																	
11208	0270	1000	XXXX	YYYY	-0000	6	270	1000	603	310	1,30	17,64	4,56	-	315	-	362
		1200				6	270	1200	705	363	1,30	21,00	5,40	-	348	-	400
		1400				6	270	1400	808	416	1,30	24,30	6,24	-	379	-	436
		1600				6	270	1600	911	467	1,31	27,66	7,08	-	409	-	470
		1800				6	270	1800	1015	522	1,30	30,90	8,10	-	440	-	506
		2000				6	270	2000	1121	580	1,29	34,20	9,12	-	473	-	544
		2200				6	270	2200	1229	636	1,29	37,50	10,08	-	503	-	578
		2400				6	270	2400	1335	691	1,29	40,80	11,10	-	534	-	614
		2600				6	270	2600	1441	746	1,29	44,10	12,12	-	564	-	649
		2800				6	270	2800	1547	800	1,29	47,34	13,14	-	595	-	684
		3000				6	270	3000	1653	855	1,29	50,64	14,16	-	627	-	721
11208	0360	1000	XXXX	YYYY	-0000	8	360	1000	804	414	1,30	23,52	6,08	-	391	-	450
		1200				8	360	1200	940	484	1,30	28,00	7,20	-	433	-	498
		1400				8	360	1400	1077	554	1,30	32,40	8,32	-	474	-	545
		1600				8	360	1600	1214	622	1,31	36,88	9,44	-	516	-	593
		1800				8	360	1800	1354	697	1,30	41,20	10,80	-	557	-	641
		2000				8	360	2000	1495	773	1,29	45,60	12,16	-	598	-	688
		2200				8	360	2200	1639	848	1,29	50,00	13,44	-	639	-	735
		2400				8	360	2400	1780	921	1,29	54,40	14,80	-	680	-	782
		2600				8	360	2600	1921	994	1,29	58,80	16,16	-	721	-	829
		2800				8	360	2800	2063	1067	1,29	63,12	17,52	-	762	-	876
		3000				8	360	3000	2204	1140	1,29	67,52	18,88	-	804	-	925
11208	0450	1000	XXXX	YYYY	-0000	10	450	1000	1005	517	1,30	29,40	7,60	-	466	-	536
		1200				10	450	1200	1175	605	1,30	35,00	9,00	-	517	-	595
		1400				10	450	1400	1346	693	1,30	40,50	10,40	-	568	-	653
		1600				10	450	1600	1518	777	1,31	46,10	11,80	-	620	-	713
		1800				10	450	1800	1692	871	1,30	51,50	13,50	-	673	11208-03	774
		2000				10	450	2000	1869	967	1,29	57,00	15,20	-	723	11208-04	831
		2200				10	450	2200	2048	1060	1,29	62,50	16,80	-	776	-	892
		2400				10	450	2400	2225	1151	1,29	68,00	18,50	-	827	-	951
		2600				10	450	2600	2402	1243	1,29	73,50	20,20	-	880	-	1012
		2800				10	450	2800	2578	1334	1,29	78,90	21,90	-	930	-	1070
		3000				10	450	3000	2755	1425	1,29	84,40	23,60	-	983	-	1130
11208	0540	1000	XXXX	YYYY	-0000	12	540	1000	1206	621	1,30	35,28	9,12	-	539	-	620
		1200				12	540	1200	1410	726	1,30	42,00	10,80	-	603	-	693
		1400				12	540	1400	1615	831	1,30	48,60	12,48	-	663	-	762
		1600				12	540	1600	1822	933	1,31	55,32	14,16	-	726	-	835
		1800				12	540	1800	2031	1045	1,30	61,80	16,20	-	788	11208-05	906
		2000				12	540	2000	2242	1160	1,29	68,40	18,24	-	849	11208-01	976
		2200				12	540	2200	2458	1272	1,29	75,00	20,16	-	913	-	1050
		2400				12	540	2400	2670	1381	1,29	81,60	22,20	-	973	-	1119
		2600				12	540	2600	2882	1491	1,29	88,20	24,24	-	1036	-	1191
		2800				12	540	2800	3094	1601	1,29	94,68	26,28	-	1098	-	1263
		3000				12	540	3000	3306	1710	1,29	101,28	28,32	-	1161	-	1335

CE 05 conform EN442-1: radiatoren en convectoren

Voor de warmteafgiftes van andere regimes, kijkt u op p. 308 (correctiefactoren)  
Prijzen in euro (excl. BTW)

# TULIPA VERTICAAL (TV2)



TV2

## HOE TULIPA VERTICAAL BESTELLEN

Leveringstermijn 15 - 30 werkdagen  
(zonder transportduur)

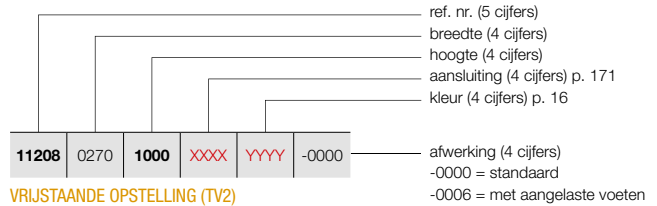

## VRIJSTAANDE OPSTELLING (TV2)

Zie p. 169 voor extra toebehoren.

## HOE VOORRAADRADIATOR TULIPA VERTICAAL BESTELLEN

Leveringstermijn 5 werkdagen  
(zonder transportduur)

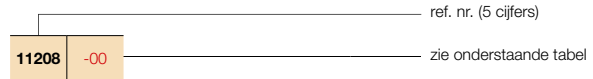

BESTELCODE MAATWERK TULIPA VERTICAAL							TECHNISCHE GEGEVENS						STANDAARDKLEUR		ANDERE KLEUREN		
buizen	breedte (L mm)	hoogte (H mm)	75/65/20 (Watt)	55/45/20 (Watt)	n-exp.	gewicht (kg)	inhoud (l)	el. weerst. (Watt)	prijs RAL 9016	verkorte ref. nr. RAL 9016 voorraad	prijs kleur						
REF. NR. TULIPA VERTICAAL TV2 : 11208																	
11208	0630	1000	XXXX	YYYY	-0000	14	630	1000	1406	724	1,30	41,16	10,64	-	615	-	707
		1200				14	630	1200	1645	847	1,30	49,00	12,60	-	687	-	790
		1400				14	630	1400	1884	970	1,30	56,70	14,56	-	759	-	873
		1600				14	630	1600	2125	1088	1,31	64,54	16,52	-	831	-	956
		1800				14	630	1800	2369	1219	1,30	72,10	18,90	-	903	11208-10	1038
		2000				14	630	2000	2616	1353	1,29	79,80	21,28	-	975	11208-11	1121
		2200				14	630	2200	2867	1483	1,29	87,50	23,52	-	1050	-	1208
		2400				14	630	2400	3115	1612	1,29	95,20	25,90	-	1122	-	1290
		2600				14	630	2600	3362	1739	1,29	102,90	28,28	-	1194	-	1373
		2800				14	630	2800	3610	1868	1,29	110,46	30,66	-	1266	-	1456
		3000				14	630	3000	3857	1996	1,29	118,16	33,04	-	1338	-	1539
11208	0720	1000	XXXX	YYYY	-0000	16	720	1000	1607	827	1,30	47,04	12,16	-	689	-	792
		1200				16	720	1200	1880	968	1,30	56,00	14,40	-	771	-	887
		1400				16	720	1400	2154	1109	1,30	64,80	16,64	-	855	-	983
		1600				16	720	1600	2429	1244	1,31	73,76	18,88	-	937	-	1078
		1800				16	720	1800	2707	1393	1,30	82,40	21,60	-	1019	-	1172
		2000				16	720	2000	2990	1547	1,29	91,20	24,32	-	1101	11208-02	1266
		2200				16	720	2200	3277	1695	1,29	100,00	26,88	-	1185	-	1363
		2400				16	720	2400	3560	1842	1,29	108,80	29,60	-	1267	-	1457
		2600				16	720	2600	3843	1988	1,29	117,60	32,32	-	1350	-	1553
		2800				16	720	2800	4125	2134	1,29	126,24	35,04	-	1433	-	1648
		3000				16	720	3000	4408	2281	1,29	135,04	37,76	-	1516	-	1743
11208	0810	1000	XXXX	YYYY	-0000	18	810	1000	1808	931	1,30	52,92	13,68	-	762	-	876
		1200				18	810	1200	2115	1089	1,30	63,00	16,20	-	856	-	984
		1400				18	810	1400	2423	1247	1,30	72,90	18,72	-	949	-	1091
		1600				18	810	1600	2733	1400	1,31	82,98	21,24	-	1042	-	1198
		1800				18	810	1800	3046	1568	1,30	92,70	24,30	-	1136	-	1306
		2000				18	810	2000	3364	1740	1,29	102,60	27,36	-	1228	-	1412
		2200				18	810	2200	3687	1908	1,29	112,50	30,24	-	1321	-	1519
		2400				18	810	2400	4005	2072	1,29	122,40	33,30	-	1415	-	1627
		2600				18	810	2600	4323	2237	1,29	132,30	36,36	-	1507	-	1733
		2800				18	810	2800	4641	2401	1,29	142,02	39,42	-	1601	-	1841
		3000				18	810	3000	4959	2566	1,29	151,92	42,48	-	1694	-	1948
11208	0900	1000	XXXX	YYYY	-0000	20	900	1000	2009	1034	1,30	58,80	15,20	-	836	-	961
		1200				20	900	1200	2350	1210	1,30	70,00	18,00	-	941	-	1082
		1400				20	900	1400	2692	1386	1,30	81,00	20,80	-	1043	-	1199
		1600				20	900	1600	3036	1555	1,31	92,20	23,60	-	1146	-	1318
		1800				20	900	1800	3384	1742	1,30	103,00	27,00	-	1251	-	1439
		2000				20	900	2000	3737	1933	1,29	114,00	30,40	-	1353	-	1556
		2200				20	900	2200	4096	2119	1,29	125,00	33,60	-	1458	-	1677
		2400				20	900	2400	4450	2302	1,29	136,00	37,00	-	1561	-	1795
		2600				20	900	2600	4803	2485	1,29	147,00	40,40	-	1663	-	1912
		2800				20	900	2800	5157	2668	1,29	157,80	43,80	-	1769	-	2034
		3000				20	900	3000	5510	2851	1,29	168,80	47,20	-	1872	-	2153

CE 05 conform EN442-1: radiatoren en convectoren

Voor de warmteafgifte van andere regimes, kijkt u op p. 308 (correctiefactoren)  
Prijzen in euro (excl. BTW)

## HOE TULIPA VERTICAAL BESTELLEN

Leveringstermijn 15 - 30 werkdagen  
(zonder transportduur)

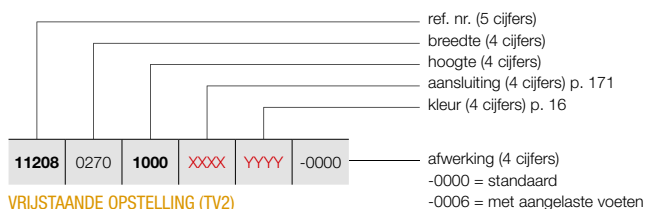

### VRIJSTAANDE OPSTELLING (TV2)

Zie p. 169 voor extra toebehoren.

## TULIPA VERTICAAL (TV2)



TV2

BESTELCODE MAATWERK TULIPA VERTICAAL	TECHNISCHE GEGEVENS									STANDAARDKLEUR		ANDERE KLEUREN					
	buizen	breedte (L mm)	hoogte (H mm)	75/65/20 (Watt)	55/45/20 (Watt)	n-exp.	gewicht (kg)	inhoud (l)	el. weerst. (Watt)	prijs RAL 9016	verkorte ref. nr. RAL 9016 voorraad	prijs kleur					
<b>REF. NR. TULIPA VERTICAAL TV2 : 11208</b>																	
<b>11208</b>	0990	<b>1000</b>	<b>XXXX</b>	<b>YYYY</b>	<b>-0000</b>	22	990	1000	2210	1138	1,30	64,68	16,72	-	<b>913</b>	-	<b>1050</b>
		<b>1200</b>				22	990	1200	2585	1331	1,30	77,00	19,80	-	<b>1026</b>	-	<b>1180</b>
		<b>1400</b>				22	990	1400	2961	1524	1,30	89,10	22,88	-	<b>1139</b>	-	<b>1310</b>
		<b>1600</b>				22	990	1600	3340	1711	1,31	101,42	25,96	-	<b>1252</b>	-	<b>1440</b>
		<b>1800</b>				22	990	1800	3723	1916	1,30	113,30	29,70	-	<b>1367</b>	-	<b>1572</b>
		<b>2000</b>				22	990	2000	4111	2127	1,29	125,40	33,44	-	<b>1480</b>	-	<b>1702</b>
		<b>2200</b>				22	990	2200	4506	2331	1,29	137,50	36,96	-	<b>1593</b>	-	<b>1832</b>
		<b>2400</b>				22	990	2400	4895	2533	1,29	149,60	40,70	-	<b>1709</b>	-	<b>1965</b>
		<b>2600</b>				22	990	2600	5284	2734	1,29	161,70	44,44	-	<b>1822</b>	-	<b>2095</b>
<b>11208</b>	1080	<b>1000</b>	<b>XXXX</b>	<b>YYYY</b>	<b>-0000</b>	24	1080	1000	2411	1241	1,30	70,56	18,24	-	<b>986</b>	-	<b>1134</b>
		<b>1200</b>				24	1080	1200	2820	1452	1,30	84,00	21,60	-	<b>1110</b>	-	<b>1277</b>
		<b>1400</b>				24	1080	1400	3230	1663	1,30	97,20	24,96	-	<b>1235</b>	-	<b>1420</b>
		<b>1600</b>				24	1080	1600	3643	1866	1,31	110,64	28,32	-	<b>1358</b>	-	<b>1562</b>
		<b>1800</b>				24	1080	1800	4061	2090	1,30	123,60	32,40	-	<b>1482</b>	-	<b>1704</b>
		<b>2000</b>				24	1080	2000	4485	2320	1,29	136,80	36,48	-	<b>1606</b>	-	<b>1847</b>
		<b>2200</b>				24	1080	2200	4916	2543	1,29	150,00	40,32	-	<b>1730</b>	-	<b>1990</b>
<b>11208</b>	1170	<b>1000</b>	<b>XXXX</b>	<b>YYYY</b>	<b>-0000</b>	26	1170	1000	2612	1345	1,30	76,44	19,76	-	<b>1060</b>	-	<b>1219</b>
		<b>1200</b>				26	1170	1200	3056	1573	1,30	91,00	23,40	-	<b>1195</b>	-	<b>1374</b>
		<b>1400</b>				26	1170	1400	3500	1802	1,30	105,30	27,04	-	<b>1329</b>	-	<b>1528</b>
		<b>1600</b>				26	1170	1600	3947	2021	1,31	119,86	30,68	-	<b>1464</b>	-	<b>1684</b>
		<b>1800</b>				26	1170	1800	4399	2264	1,30	133,90	35,10	-	<b>1599</b>	-	<b>1839</b>
		<b>2000</b>				26	1170	2000	4859	2514	1,29	148,20	39,52	-	<b>1732</b>	-	<b>1992</b>
<b>11208</b>	1260	<b>1000</b>	<b>XXXX</b>	<b>YYYY</b>	<b>-0000</b>	28	1260	1000	2813	1448	1,30	82,32	21,28	-	<b>1134</b>	-	<b>1304</b>
		<b>1200</b>				28	1260	1200	3291	1694	1,30	98,00	25,20	-	<b>1280</b>	-	<b>1472</b>
		<b>1400</b>				28	1260	1400	3769	1940	1,30	113,40	29,12	-	<b>1424</b>	-	<b>1638</b>
		<b>1600</b>				28	1260	1600	4251	2177	1,31	129,08	33,04	-	<b>1569</b>	-	<b>1804</b>
		<b>1800</b>				28	1260	1800	4738	2439	1,30	144,20	37,80	-	<b>1714</b>	-	<b>1971</b>

CE 05 conform EN442-1: radiatoren en convectoren

Voor de warmteafgiftes van andere regimes, kijkt u op p. 308 (correctiefactoren)  
Prijzen in euro (excl. BTW)



## TULIPA HORIZONTAAL (TH1, TH2)



### TYPES

- Eén (TH1) of twee rijen buizen (TH2)

### BUIZEN

- Verticaal, platovaal 57,5 x 10 mm

### COLLECTOREN

- Horizontaal, achterliggend, rond Ø 35 mm

### KLEUREN

- Standaardkleur wit RAL 9016
- Niet verkrijgbaar in kleur Gloss White
- Uitgebreide kleurenkaart zie p. 16

### SPECIAAL

- TH1 ook verkrijgbaar als toiletradiator (540 x 500 mm)

### BEVESTIGINGEN

- Muurbevestigingen standaard
- TH1 / TH2 ook verkrijgbaar als vrijstaande opstelling, zie p. 169
- Bij vrijstaande opstelling de K-maat (afstand vloer / radiator) en B-maat (afstand radiator / plafond) opgeven.

### TECHNISCH

- Weerstandsgelast (onzichtbare lasnaden)
- KTL-grondlaag, poedercoating
- Standaardwerkdruk: 4 bar. Meerprijs hogere werkdruk (10 bar): +10%.
- De leveringstermijn van radiator met een hogere werkdruk is 1 week extra.
- Maximale bedrijfstemperatuur: 110°C

### ELEKTRISCH (zie hoofdstuk elektrische radiatoren)

- ✗ Zuiver elektrische radiator in de fabriek voorgevuld
- ✗ Gemengde radiator

### TECHNISCHE TEKENINGEN

- Zie p. 172

### AANSLUITING

- ✓ Eénpuntsaansluiting voor éénpijpssysteem (radiator speciaal te bestellen) (zie p. 301)
- ✓ Eénpuntsaansluiting voor tweepijpssysteem (radiator speciaal te bestellen) (zie p. 301)
- ✓ Tweepuntsaansluiting voor éénpijpssysteem (aansluiting via de middenaansluiting) (zie p. 300)
- ✓ Tweepuntsaansluiting voor tweepijpssysteem (standaard) (zie p. 300)
- ✗ Geïntegreerd ventiel

### OVER TULIPA HORIZONTAAL

#### Eeuwige charme, tijdloze klasse

De horizontale versie van de Tulipa. Het schoolvoorbeeld van een designradiator in zijn meest authentieke vorm. Gekenmerkt door de klassieke open structuur en de loodrechte aansluiting van de buizen op de collector. Een designradiator die blijft charmeren. Trendoverstijgend en overal toepasbaar.

#### AANBEVOLEN AANSLUITING (0018)

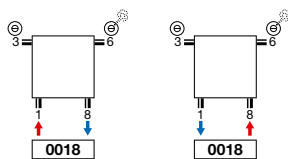

art. nr. 118210100000099  
**prijs € 155**  
Koppelingen, zie p. 313

#### AANBEVOLEN VOOR BADKAMER IN OPTIE



handdoekbeugel (chrom) art. nr. 118322200000099  
**prijs € 166**

Andere aansluitmogelijkheden, zie p. 171

Andere accessoires, zie p. 170



TH1 / TH2

## HOE TULIPA HORIZONTAAL BESTELLEN

Leveringstermijn 15 - 30 werkdagen  
(zonder transportduur)

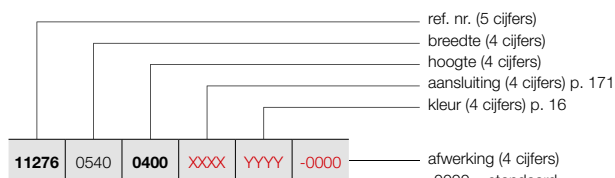

### VRIJSTAANDE OPSTELLING (TH1)

Zie p. 169 voor extra toebehoren.

## TULIPA HORIZONTAAL (TH1)

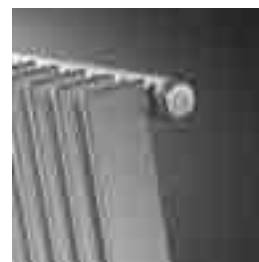

TH1

BESTELCODE MAATWERK TULIPA HORIZONTAAL	TECHNISCHE GEGEVENS									STANDAARDKLEUR	ANDERE KLEUREN					
	buizen	breedte (L mm)	hoogte (H mm)	75/65/20 (Watt)	55/45/20 (Watt)	n-exp.	gewicht (kg)	inhoud (l)	el. weerst. (Watt)	prijs RAL 9016	prijs kleur					
<b>REF. NR. TULIPA HORIZONTAAL TH1 : 11276</b>																
<b>11276</b>	0540	<b>0400</b>	<b>XXXX</b>	<b>YYYY</b>	<b>-0000</b>	12	540	400	330	178	1,21	8,52	2,64	-	<b>202</b>	<b>232</b>
		<b>0500</b>				12	540	500	396	212	1,22	10,20	3,00	-	<b>219</b>	<b>252</b>
		<b>0600</b>				12	540	600	460	245	1,23	11,88	3,48	-	<b>237</b>	<b>273</b>
		<b>0700</b>				12	540	700	523	278	1,24	13,56	3,96	-	<b>255</b>	<b>293</b>
		<b>0800</b>				12	540	800	587	310	1,25	15,24	4,44	-	<b>273</b>	<b>314</b>
		<b>0900</b>				12	540	900	651	342	1,26	16,92	4,80	-	<b>290</b>	<b>334</b>
<b>11276</b>	0630	<b>0400</b>	<b>XXXX</b>	<b>YYYY</b>	<b>-0000</b>	14	630	400	385	208	1,21	9,94	3,08	-	<b>227</b>	<b>261</b>
		<b>0500</b>				14	630	500	461	247	1,22	11,90	3,50	-	<b>247</b>	<b>284</b>
		<b>0600</b>				14	630	600	536	286	1,23	13,86	4,06	-	<b>268</b>	<b>308</b>
		<b>0700</b>				14	630	700	611	324	1,24	15,82	4,62	-	<b>288</b>	<b>331</b>
		<b>0800</b>				14	630	800	685	362	1,25	17,78	5,18	-	<b>309</b>	<b>355</b>
		<b>0900</b>				14	630	900	759	399	1,26	19,74	5,60	-	<b>330</b>	<b>380</b>
<b>11276</b>	0720	<b>0400</b>	<b>XXXX</b>	<b>YYYY</b>	<b>-0000</b>	16	720	400	440	237	1,21	11,36	3,52	-	<b>251</b>	<b>289</b>
		<b>0500</b>				16	720	500	527	283	1,22	13,60	4,00	-	<b>275</b>	<b>316</b>
		<b>0600</b>				16	720	600	613	327	1,23	15,84	4,64	-	<b>299</b>	<b>344</b>
		<b>0700</b>				16	720	700	698	370	1,24	18,08	5,28	-	<b>322</b>	<b>370</b>
		<b>0800</b>				16	720	800	783	413	1,25	20,32	5,92	-	<b>346</b>	<b>398</b>
		<b>0900</b>				16	720	900	868	456	1,26	22,56	6,40	-	<b>370</b>	<b>426</b>
<b>11276</b>	0810	<b>0400</b>	<b>XXXX</b>	<b>YYYY</b>	<b>-0000</b>	18	810	400	495	267	1,21	12,78	3,96	-	<b>276</b>	<b>317</b>
		<b>0500</b>				18	810	500	593	318	1,22	15,30	4,50	-	<b>303</b>	<b>348</b>
		<b>0600</b>				18	810	600	690	368	1,23	17,82	5,22	-	<b>330</b>	<b>380</b>
		<b>0700</b>				18	810	700	785	417	1,24	20,34	5,94	-	<b>356</b>	<b>409</b>
		<b>0800</b>				18	810	800	881	465	1,25	22,86	6,66	-	<b>382</b>	<b>439</b>
		<b>0900</b>				18	810	900	976	513	1,26	25,38	7,20	-	<b>409</b>	<b>470</b>
<b>11276</b>	0900	<b>0400</b>	<b>XXXX</b>	<b>YYYY</b>	<b>-0000</b>	20	900	400	550	296	1,21	14,20	4,40	-	<b>301</b>	<b>346</b>
		<b>0500</b>				20	900	500	659	353	1,22	17,00	5,00	-	<b>331</b>	<b>381</b>
		<b>0600</b>				20	900	600	766	409	1,23	19,80	5,80	-	<b>361</b>	<b>415</b>
		<b>0700</b>				20	900	700	872	463	1,24	22,60	6,60	-	<b>389</b>	<b>447</b>
		<b>0800</b>				20	900	800	978	516	1,25	25,40	7,40	-	<b>419</b>	<b>482</b>
		<b>0900</b>				20	900	900	1084	570	1,26	28,20	8,00	-	<b>449</b>	<b>516</b>
<b>11276</b>	0990	<b>0400</b>	<b>XXXX</b>	<b>YYYY</b>	<b>-0000</b>	22	990	400	605	326	1,21	15,62	4,84	-	<b>325</b>	<b>374</b>
		<b>0500</b>				22	990	500	725	389	1,22	18,70	5,50	-	<b>358</b>	<b>412</b>
		<b>0600</b>				22	990	600	843	450	1,23	21,78	6,38	-	<b>390</b>	<b>449</b>
		<b>0700</b>				22	990	700	960	510	1,24	24,86	7,26	-	<b>423</b>	<b>486</b>
		<b>0800</b>				22	990	800	1076	568	1,25	27,94	8,14	-	<b>455</b>	<b>523</b>
		<b>0900</b>				22	990	900	1193	627	1,26	31,02	8,80	-	<b>488</b>	<b>561</b>
<b>11276</b>	1080	<b>0400</b>	<b>XXXX</b>	<b>YYYY</b>	<b>-0000</b>	24	1080	400	660	356	1,21	17,04	5,28	-	<b>350</b>	<b>403</b>
		<b>0500</b>				24	1080	500	791	424	1,22	20,40	6,00	-	<b>386</b>	<b>444</b>
		<b>0600</b>				24	1080	600	920	491	1,23	23,76	6,96	-	<b>421</b>	<b>484</b>
		<b>0700</b>				24	1080	700	1047	556	1,24	27,12	7,92	-	<b>457</b>	<b>526</b>
		<b>0800</b>				24	1080	800	1174	620	1,25	30,48	8,88	-	<b>492</b>	<b>566</b>
		<b>0900</b>				24	1080	900	1301	684	1,26	33,84	9,60	-	<b>527</b>	<b>606</b>

CE05 conform EN442-1: radiatoren en convectoren

Voor de warmteafgiftes van andere regimes, kijkt u op p. 308 (correctiefactoren)  
Prijzen in euro (excl. BTW)

# TULIPA HORIZONTAAL (TH1)

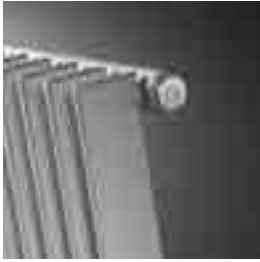

TH1

## HOE TULIPA HORIZONTAAL BESTELLEN

Leveringstermijn 15 - 30 werkdagen  
(zonder transportduur)

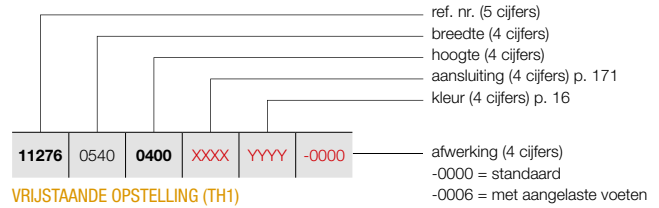

## VRIJSTAANDE OPSTELLING (TH1)

Zie p. 169 voor extra toebehoren.

BESTELCODE MAATWERK TULIPA HORIZONTAAL							TECHNISCHE GEGEVENS						STANDAARDKLEUR	ANDERE KLEUREN		
REF. NR.	BUIS	BREEDTE	HOOGTE	75/65/20	55/45/20	n-exp.	gewicht	inhoud	el. weerst.	prijs RAL 9016	prijs kleur					
	(L mm)	(H mm)	(Watt)	(Watt)		(kg)	(l)	(Watt)								
REF. NR. TULIPA HORIZONTAAL TH1 : 11276																
11276	1170	0400	XXXX	YYYY	-0000	26	1170	400	716	386	1,21	18,46	5,72	-	375	431
		0500				26	1170	500	857	460	1,22	22,10	6,50	-	414	476
		0600				26	1170	600	996	531	1,23	25,74	7,54	-	452	520
		0700				26	1170	700	1134	602	1,24	29,38	8,58	-	490	564
		0800				26	1170	800	1272	672	1,25	33,02	9,62	-	529	608
		0900				26	1170	900	1410	741	1,26	36,66	10,40	-	568	653
11276	1260	0400	XXXX	YYYY	-0000	28	1260	400	771	416	1,21	19,88	6,16	-	400	460
		0500				28	1260	500	923	495	1,22	23,80	7,00	-	442	508
		0600				28	1260	600	1073	572	1,23	27,72	8,12	-	483	555
		0700				28	1260	700	1221	648	1,24	31,64	9,24	-	524	603
		0800				28	1260	800	1370	723	1,25	35,56	10,36	-	565	650
		0900				28	1260	900	1518	798	1,26	39,48	11,20	-	607	698
11276	1440	0400	XXXX	YYYY	-0000	32	1440	400	881	475	1,21	22,72	7,04	-	449	516
		0500				32	1440	500	1055	566	1,22	27,20	8,00	-	496	570
		0600				32	1440	600	1226	654	1,23	31,68	9,28	-	544	626
		0700				32	1440	700	1396	741	1,24	36,16	10,56	-	591	680
		0800				32	1440	800	1565	826	1,25	40,64	11,84	-	639	735
		0900				32	1440	900	1735	912	1,26	45,12	12,80	-	686	789
11276	1620	0400	XXXX	YYYY	-0000	36	1620	400	991	534	1,21	25,56	7,92	-	500	575
		0500				36	1620	500	1187	636	1,22	30,60	9,00	-	552	635
		0600				36	1620	600	1380	736	1,23	35,64	10,44	-	606	697
		0700				36	1620	700	1570	833	1,24	40,68	11,88	-	658	757
		0800				36	1620	800	1761	930	1,25	45,72	13,32	-	712	819
		0900				36	1620	900	1952	1026	1,26	50,76	14,40	-	765	880
11276	1800	0400	XXXX	YYYY	-0000	40	1800	400	1101	593	1,21	28,40	8,80	-	549	631
		0500				40	1800	500	1318	707	1,22	34,00	10,00	-	608	699
		0600				40	1800	600	1533	818	1,23	39,60	11,60	-	666	766
		0700				40	1800	700	1745	926	1,24	45,20	13,20	-	726	835
		0800				40	1800	800	1957	1033	1,25	50,80	14,80	-	785	903
		0900				40	1800	900	2169	1140	1,26	56,40	16,00	-	845	972
11276	1980	0400	XXXX	YYYY	-0000	44	1980	400	1211	653	1,21	31,24	9,68	-	598	688
		0500				44	1980	500	1450	778	1,22	37,40	11,00	-	663	762
		0600				44	1980	600	1686	899	1,23	43,56	12,76	-	728	837
		0700				44	1980	700	1919	1019	1,24	49,72	14,52	-	793	912
		0800				44	1980	800	2152	1136	1,25	55,88	16,28	-	858	987
		0900				44	1980	900	2386	1254	1,26	62,04	17,60	-	923	1061
11276	2160	0400	XXXX	YYYY	-0000	48	2160	400	1321	712	1,21	34,08	10,56	-	648	745
		0500				48	2160	500	1582	848	1,22	40,80	12,00	-	719	827
		0600				48	2160	600	1839	981	1,23	47,52	13,92	-	790	909
		0700				48	2160	700	2094	1111	1,24	54,24	15,84	-	860	989
		0800				48	2160	800	2348	1240	1,25	60,96	17,76	-	931	1071
		0900				48	2160	900	2603	1368	1,26	67,68	19,20	-	1002	1152

CE<sub>05</sub> conform EN442-1: radiatoren en convectoren

Voor de warmteafgiftes van andere regimes, kijkt u op p. 308 (correctiefactoren)  
 Prijzen in euro (excl. BTW)

## HOE TULIPA HORIZONTAAL BESTELLEN

Leveringstermijn 15 - 30 werkdagen  
(zonder transportduur)

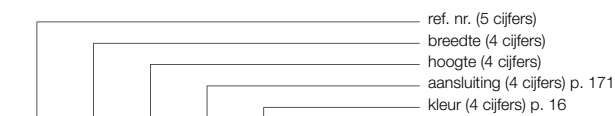

<b>11276</b>	0540	<b>0400</b>	XXXX	YYYY	-0000
--------------	------	-------------	------	------	-------

afwerking (4 cijfers)  
-0000 = standaard  
-0006 = met aangelaste voeten

### VRIJSTAANDE OPSTELLING (TH1)

Zie p. 169 voor extra toebehoren.

## TULIPA HORIZONTAAL (TH1)

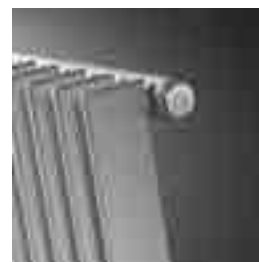

TH1

BESTELCODE MAATWERK TULIPA HORIZONTAAL	TECHNISCHE GEGEVENS									STANDAARDKLEUR	ANDERE KLEUREN					
	buizen	breedte (L mm)	hoogte (H mm)	75/65/20 (Watt)	55/45/20 (Watt)	n-exp.	gewicht (kg)	inhoud (l)	el. weerst. (Watt)	prijs RAL 9016	prijs kleur					
<b>REF. NR. TULIPA HORIZONTAAL TH1 : 11276</b>																
<b>11276</b>	2340	<b>0400</b>	XXXX	YYYY	-0000	52	2340	400	1431	771	1,21	36,92	11,44	-	<b>697</b>	<b>802</b>
		<b>0500</b>				52	2340	500	1714	919	1,22	44,20	13,00	-	<b>775</b>	<b>891</b>
		<b>0600</b>				52	2340	600	1993	1063	1,23	51,48	15,08	-	<b>851</b>	<b>979</b>
		<b>0700</b>				52	2340	700	2268	1204	1,24	58,76	17,16	-	<b>928</b>	<b>1067</b>
		<b>0800</b>				52	2340	800	2544	1343	1,25	66,04	19,24	-	<b>1004</b>	<b>1155</b>
		<b>0900</b>				52	2340	900	2819	1481	1,26	73,32	20,80	-	<b>1082</b>	<b>1244</b>
<b>11276</b>	2520	<b>0400</b>	XXXX	YYYY	-0000	56	2520	400	1541	831	1,21	39,76	12,32	-	<b>747</b>	<b>859</b>
		<b>0500</b>				56	2520	500	1846	990	1,22	47,60	14,00	-	<b>829</b>	<b>953</b>
		<b>0600</b>				56	2520	600	2146	1145	1,23	55,44	16,24	-	<b>913</b>	<b>1050</b>
		<b>0700</b>				56	2520	700	2443	1297	1,24	63,28	18,48	-	<b>995</b>	<b>1144</b>
		<b>0800</b>				56	2520	800	2740	1447	1,25	71,12	20,72	-	<b>1077</b>	<b>1239</b>
		<b>0900</b>				56	2520	900	3036	1595	1,26	78,96	22,40	-	<b>1161</b>	<b>1335</b>
<b>11276</b>	2700	<b>0400</b>	XXXX	YYYY	-0000	60	2700	400	1651	890	1,21	42,60	13,20	-	<b>796</b>	<b>915</b>
		<b>0500</b>				60	2700	500	1978	1061	1,22	51,00	15,00	-	<b>885</b>	<b>1018</b>
		<b>0600</b>				60	2700	600	2299	1226	1,23	59,40	17,40	-	<b>973</b>	<b>1119</b>
		<b>0700</b>				60	2700	700	2617	1389	1,24	67,80	19,80	-	<b>1062</b>	<b>1221</b>
		<b>0800</b>				60	2700	800	2935	1550	1,25	76,20	22,20	-	<b>1151</b>	<b>1324</b>
		<b>0900</b>				60	2700	900	3253	1709	1,26	84,60	24,00	-	<b>1240</b>	<b>1426</b>
<b>11276</b>	2880	<b>0400</b>	XXXX	YYYY	-0000	64	2880	400	1761	949	1,21	45,44	14,08	-	<b>846</b>	<b>973</b>
		<b>0500</b>				64	2880	500	2109	1131	1,22	54,40	16,00	-	<b>940</b>	<b>1081</b>
		<b>0600</b>				64	2880	600	2452	1308	1,23	63,36	18,56	-	<b>1035</b>	<b>1190</b>
		<b>0700</b>				64	2880	700	2792	1482	1,24	72,32	21,12	-	<b>1130</b>	<b>1300</b>
		<b>0800</b>				64	2880	800	3131	1653	1,25	81,28	23,68	-	<b>1225</b>	<b>1409</b>
		<b>0900</b>				64	2880	900	3470	1823	1,26	90,24	25,60	-	<b>1318</b>	<b>1516</b>
<b>11276</b>	3060	<b>0400</b>	XXXX	YYYY	-0000	68	3060	400	1871	1008	1,21	48,28	14,96	-	<b>895</b>	<b>1029</b>
		<b>0500</b>				68	3060	500	2241	1202	1,22	57,80	17,00	-	<b>996</b>	<b>1145</b>
		<b>0600</b>				68	3060	600	2606	1390	1,23	67,32	19,72	-	<b>1096</b>	<b>1260</b>
		<b>0700</b>				68	3060	700	2966	1574	1,24	76,84	22,44	-	<b>1197</b>	<b>1377</b>
		<b>0800</b>				68	3060	800	3327	1757	1,25	86,36	25,16	-	<b>1298</b>	<b>1493</b>
		<b>0900</b>				68	3060	900	3687	1937	1,26	95,88	27,20	-	<b>1398</b>	<b>1608</b>

CE 05 conform EN442-1: radiatoren en convectoren

Voor de warmteafgiftes van andere regimes, kijkt u op p. 308 (correctiefactoren)  
Prijzen in euro (excl. BTW)

# TULIPA HORIZONTAAL (TH2)



TH2

## HOE TULIPA HORIZONTAAL BESTELLEN

Leveringstermijn 15 - 30 werkdagen  
(zonder transportduur)

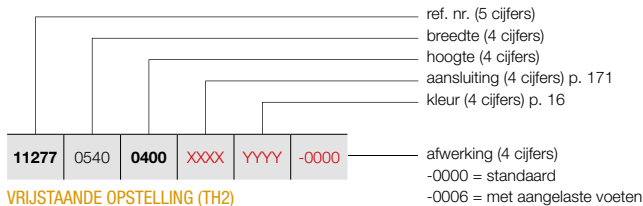

## VRIJSTAANDE OPSTELLING (TH2)

Zie p. 169 voor extra toebehoren.

BESTELCODE MAATWERK TULIPA HORIZONTAAL						TECHNISCHE GEGEVENS						STANDAARDKLEUR	ANDERE KLEUREN			
buizen	breedte (L mm)	hoogte (H mm)	75/65/20 (Watt)	55/45/20 (Watt)	n-exp.	gewicht (kg)	inhoud (l)	el. weerst. (Watt)	prijs RAL 9016	prijs kleur						
REF. NR. TULIPA HORIZONTAAL TH2 : 11277																
11277	0540	0400	XXXX	YYYY	-0000	12	540	400	571	303	1,24	14,52	4,44	-	353	406
		0500				12	540	500	682	360	1,25	18,00	5,16	-	384	442
		0600				12	540	600	790	415	1,26	21,48	6,00	-	415	477
		0700				12	540	700	895	468	1,27	24,96	6,84	-	447	514
		0800				12	540	800	1000	520	1,28	28,44	7,56	-	478	550
		0900				12	540	900	1103	571	1,29	31,80	8,40	-	509	585
11277	0630	0400	XXXX	YYYY	-0000	14	630	400	667	354	1,24	16,94	5,18	-	397	457
		0500				14	630	500	796	420	1,25	21,00	6,02	-	433	498
		0600				14	630	600	921	484	1,26	25,06	7,00	-	469	539
		0700				14	630	700	1045	546	1,27	29,12	7,98	-	505	581
		0800				14	630	800	1166	606	1,28	33,18	8,82	-	541	622
		0900				14	630	900	1287	666	1,29	37,10	9,80	-	577	664
11277	0720	0400	XXXX	YYYY	-0000	16	720	400	762	404	1,24	19,36	5,92	-	440	506
		0500				16	720	500	910	481	1,25	24,00	6,88	-	481	553
		0600				16	720	600	1053	553	1,26	28,64	8,00	-	523	601
		0700				16	720	700	1194	624	1,27	33,28	9,12	-	564	649
		0800				16	720	800	1333	693	1,28	37,92	10,08	-	606	697
		0900				16	720	900	1471	761	1,29	42,40	11,20	-	647	744
11277	0810	0400	XXXX	YYYY	-0000	18	810	400	857	455	1,24	21,78	6,66	-	483	555
		0500				18	810	500	1023	540	1,25	27,00	7,74	-	530	610
		0600				18	810	600	1185	623	1,26	32,22	9,00	-	577	664
		0700				18	810	700	1343	702	1,27	37,44	10,26	-	624	718
		0800				18	810	800	1499	780	1,28	42,66	11,34	-	668	768
		0900				18	810	900	1654	856	1,29	47,70	12,60	-	716	823
11277	0900	0400	XXXX	YYYY	-0000	20	900	400	952	505	1,24	24,20	7,40	-	526	605
		0500				20	900	500	1137	600	1,25	30,00	8,60	-	579	666
		0600				20	900	600	1316	691	1,26	35,80	10,00	-	631	726
		0700				20	900	700	1492	780	1,27	41,60	11,40	-	682	784
		0800				20	900	800	1666	866	1,28	47,40	12,60	-	733	843
		0900				20	900	900	1838	951	1,29	53,00	14,00	-	786	904
11277	0990	0400	XXXX	YYYY	-0000	22	990	400	1048	556	1,24	26,62	8,14	-	570	656
		0500				22	990	500	1251	661	1,25	33,00	9,46	-	627	721
		0600				22	990	600	1448	761	1,26	39,38	11,00	-	683	785
		0700				22	990	700	1642	858	1,27	45,76	12,54	-	741	852
		0800				22	990	800	1833	953	1,28	52,14	13,86	-	797	917
		0900				22	990	900	2022	1046	1,29	58,30	15,40	-	855	983
11277	1080	0400	XXXX	YYYY	-0000	24	1080	400	1143	607	1,24	29,04	8,88	-	613	705
		0500				24	1080	500	1364	720	1,25	36,00	10,32	-	676	777
		0600				24	1080	600	1580	830	1,26	42,96	12,00	-	737	848
		0700				24	1080	700	1791	936	1,27	49,92	13,68	-	800	920
		0800				24	1080	800	1999	1040	1,28	56,88	15,12	-	862	991
		0900				24	1080	900	2206	1141	1,29	63,60	16,80	-	923	1061

CE<sub>05</sub> conform EN442-1: radiatoren en convectoren

Voor de warmteafgiftes van andere regimes, kijkt u op p. 308 (correctiefactoren)  
Prijzen in euro (excl. BTW)

**HOE TULIPA HORIZONTAAL BESTELLEN**

Leveringstermijn 15 - 30 werkdagen  
(zonder transportduur)

**TULIPA HORIZONTAAL (TH2)**

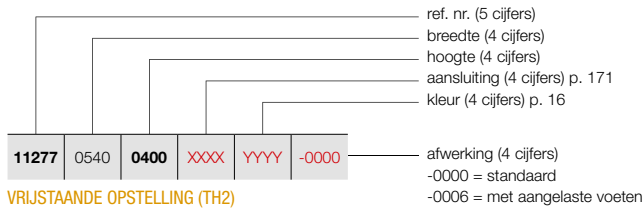

TH2

**VRIJSTAANDE OPSTELLING (TH2)**

Zie p. 169 voor extra toebehoren.

BESTELCODE MAATWERK TULIPA HORIZONTAAL	TECHNISCHE GEGEVENS									STANDAARDKLEUR	ANDERE KLEUREN					
	buizen	breedte (L mm)	hoogte (H mm)	75/65/20 (Watt)	55/45/20 (Watt)	n-exp.	gewicht (kg)	inhoud (l)	el. weerst. (Watt)	prijs RAL 9016	prijs kleur					
<b>REF. NR. TULIPA HORIZONTAAL TH2 : 11277</b>																
11277	0540	0400	XXXX	YYYY	-0000	26	1170	400	1238	657	1,24	31,46	9,62	-	656	754
						26	1170	500	1478	780	1,25	39,00	11,18	-	725	834
						26	1170	600	1711	899	1,26	46,54	13,00	-	791	910
						26	1170	700	1940	1014	1,27	54,08	14,82	-	858	987
						26	1170	800	2166	1126	1,28	61,62	16,38	-	927	1066
						26	1170	900	2390	1237	1,29	68,90	18,20	-	993	1142
						26	1170	900	2390	1237	1,29	68,90	18,20	-	993	1142
11277	1260	0400	XXXX	YYYY	-0000	28	1260	400	1333	708	1,24	33,88	10,36	-	699	804
						28	1260	500	1592	841	1,25	42,00	12,04	-	774	890
						28	1260	600	1843	968	1,26	50,12	14,00	-	846	973
						28	1260	700	2089	1092	1,27	58,24	15,96	-	918	1056
						28	1260	800	2332	1213	1,28	66,36	17,64	-	990	1139
						28	1260	900	2573	1331	1,29	74,20	19,60	-	1062	1221
						28	1260	900	2573	1331	1,29	74,20	19,60	-	1062	1221
11277	1440	0400	XXXX	YYYY	-0000	32	1440	400	1524	809	1,24	38,72	11,84	-	786	904
						32	1440	500	1819	961	1,25	48,00	13,76	-	869	999
						32	1440	600	2106	1106	1,26	57,28	16,00	-	952	1095
						32	1440	700	2388	1248	1,27	66,56	18,24	-	1035	1190
						32	1440	800	2666	1386	1,28	75,84	20,16	-	1118	1286
						32	1440	900	2941	1522	1,29	84,80	22,40	-	1201	1381
						32	1440	900	2941	1522	1,29	84,80	22,40	-	1201	1381
11277	1620	0400	XXXX	YYYY	-0000	36	1620	400	1714	910	1,24	43,56	13,32	-	874	1005
						36	1620	500	2047	1081	1,25	54,00	15,48	-	966	1111
						36	1620	600	2370	1245	1,26	64,44	18,00	-	1060	1219
						36	1620	700	2686	1404	1,27	74,88	20,52	-	1152	1325
						36	1620	800	2999	1560	1,28	85,32	22,68	-	1245	1432
						36	1620	900	3309	1712	1,29	95,40	25,20	-	1339	1540
						36	1620	900	3309	1712	1,29	95,40	25,20	-	1339	1540
11277	1800	0400	XXXX	YYYY	-0000	40	1800	400	1905	1011	1,24	48,40	14,80	-	961	1105
						40	1800	500	2274	1201	1,25	60,00	17,20	-	1064	1224
						40	1800	600	2633	1383	1,26	71,60	20,00	-	1166	1341
						40	1800	700	2985	1560	1,27	83,20	22,80	-	1271	1462
						40	1800	800	3332	1733	1,28	94,80	25,20	-	1374	1580
						40	1800	900	3676	1902	1,29	106,00	28,00	-	1478	1700
						40	1800	900	3676	1902	1,29	106,00	28,00	-	1478	1700
11277	1980	0400	XXXX	YYYY	-0000	44	1980	400	2095	1112	1,24	53,24	16,28	-	1048	1205
						44	1980	500	2501	1321	1,25	66,00	18,92	-	1161	1335
						44	1980	600	2896	1521	1,26	78,76	22,00	-	1274	1465
						44	1980	700	3283	1716	1,27	91,52	25,08	-	1388	1596
						44	1980	800	3665	1906	1,28	104,28	27,72	-	1502	1727
						44	1980	900	4044	2092	1,29	116,60	30,80	-	1615	1857
						44	1980	900	4044	2092	1,29	116,60	30,80	-	1615	1857
11277	2160	0400	XXXX	YYYY	-0000	48	2160	400	2286	1213	1,24	58,08	17,76	-	1134	1304
						48	2160	500	2729	1441	1,25	72,00	20,64	-	1259	1448
						48	2160	600	3159	1660	1,26	85,92	24,00	-	1382	1589
						48	2160	700	3582	1872	1,27	99,84	27,36	-	1505	1731
						48	2160	800	3998	2079	1,28	113,76	30,24	-	1629	1873
						48	2160	900	4412	2283	1,29	127,20	33,60	-	1754	2017
						48	2160	900	4412	2283	1,29	127,20	33,60	-	1754	2017

CE05 conform EN442-1: radiatoren en convectoren

Voor de warmteafgiftes van andere regimes, kijkt u op p. 308 (correctiefactoren)  
Prijzen in euro (excl. BTW)

# TULIPA HORIZONTAAL (TH2)



TH2

## HOE TULIPA HORIZONTAAL BESTELLEN

Leveringstermijn 15 - 30 werkdagen  
(zonder transportduur)

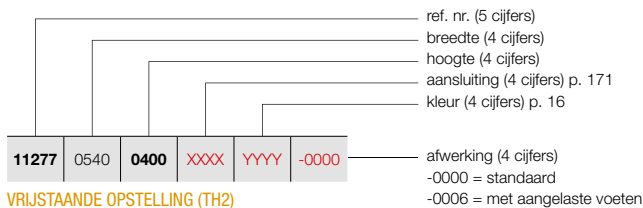



## VRIJSTAANDE OPSTELLING (TH2)

Zie p. 169 voor extra toebehoren.





BESTELCODE MAATWERK TULIPA HORIZONTAAL							TECHNISCHE GEGEVENS						STANDAARDKLEUR	ANDERE KLEUREN		
REF. NR.	BREEDTE (L mm)	HOOGTE (H mm)	75/65/20 (Watt)	55/45/20 (Watt)	n-exp.	gewicht (kg)	inhoud (l)	el. weerst. (Watt)	prijs RAL 9016	prijs kleur						
REF. NR. TULIPA HORIZONTAAL TH2 : 11277																
11277	2340	0400	XXXX	YYYY	-0000	52	2340	400	2476	1314	1,24	62,92	19,24	-	1221	1404
		0500				52	2340	500	2956	1561	1,25	78,00	22,36	-	1355	1558
		0600				52	2340	600	3423	1798	1,26	93,08	26,00	-	1489	1712
		0700				52	2340	700	3880	2028	1,27	108,16	29,64	-	1624	1868
		0800				52	2340	800	4332	2253	1,28	123,24	32,76	-	1757	2021
		0900				52	2340	900	4779	2473	1,29	137,80	36,40	-	1893	2177
11277	2520	0400	XXXX	YYYY	-0000	56	2520	400	2667	1416	1,24	67,76	20,72	-	1307	1503
		0500				56	2520	500	3184	1681	1,25	84,00	24,08	-	1451	1669
		0600				56	2520	600	3686	1937	1,26	100,24	28,00	-	1598	1838
		0700				56	2520	700	4179	2184	1,27	116,48	31,92	-	1742	2003
		0800				56	2520	800	4665	2426	1,28	132,72	35,28	-	1886	2169
		0900				56	2520	900	5147	2663	1,29	148,40	39,20	-	2031	2336
11277	2700	0400	XXXX	YYYY	-0000	60	2700	400	2857	1516	1,24	72,60	22,20	-	1394	1603
		0500				60	2700	500	3411	1801	1,25	90,00	25,80	-	1548	1780
		0600				60	2700	600	3949	2075	1,26	107,40	30,00	-	1704	1960
		0700				60	2700	700	4477	2340	1,27	124,80	34,20	-	1858	2137
		0800				60	2700	800	4998	2599	1,28	142,20	37,80	-	2014	2316
11277	2880	0400	XXXX	YYYY	-0000	64	2880	400	3048	1618	1,24	77,44	23,68	-	1480	1702
		0500				64	2880	500	3638	1921	1,25	96,00	27,52	-	1646	1893
		0600				64	2880	600	4212	2213	1,26	114,56	32,00	-	1812	2084
		0700				64	2880	700	4776	2496	1,27	133,12	36,48	-	1978	2275
11277	3060	0400	XXXX	YYYY	-0000	68	3060	400	3238	1719	1,24	82,28	25,16	-	1567	1802
		0500				68	3060	500	3866	2042	1,25	102,00	29,24	-	1743	2004
		0600				68	3060	600	4476	2352	1,26	121,72	34,00	-	1918	2206
		0700				68	3060	700	5074	2652	1,27	141,44	38,76	-	2095	2409

CE 05 conform EN442-1: radiatoren en convectoren

Voor de warmteafgiftes van andere regimes, kijkt u op p. 308 (correctiefactoren)  
Prijzen in euro (excl. BTW)

ACCESSOIRES		KLEUR	ART. NR.	€
<b>VRIJSTAANDE OPSTELLING VASTE VOETEN</b> 	<b>TV1 / TV2 / TH1 / TH2</b>			
		RAL 9016	118100700009016	<b>62</b>
		KLEUR	11810070000xxxx	<b>71</b>
<ul style="list-style-type: none"> <li>• Radiatoren in de kleur RAL 9016 en Pergamon krijgen 1 aparte zijbevestiging, 2 voeten (H=150 mm) en 2 rosetten in de betreffende kleur.</li> <li>• Radiatoren in overige kleuren krijgen 1 aparte zijbevestiging, 2 voeten (H=150 mm) in de kleur van de radiator en 2 verchromde rosetten.</li> <li>• Niet voor radiatoren ≥ 1800 mm</li> </ul>				
<b>VRIJSTAANDE OPSTELLING SET TELESCOPISCHE VOETEN / PLAFONDSTEUNEN</b> 	<b>TV1 / TV2 / TH1 / TH2</b>			
		RAL 9016	118100900009016	<b>67 / set</b>
		KLEUR	11810090000xxxx	<b>77 / set</b>
<ul style="list-style-type: none"> <li>• Telescopische voeten: afstand vloer-radiator (= K-maat) opgeven.</li> <li>• Telescopische plafondsteun: afstand plafond-radiator (= B-maat) opgeven. Lengte: min. 151 mm, max. 225 mm.</li> </ul>				
<b>VASTE VOET / ZIJBEVESTIGING</b> 	<b>TV1 / TH1</b>			
		RAL 9016	*	<b>55</b>
		KLEUR	*	<b>63</b>
	<b>TV2 / TH2</b>			
		RAL 9016	*	<b>109</b>
		KLEUR	*	<b>126</b>
<ul style="list-style-type: none"> <li>• Het bovendeel van de voet maakt deel uit van de radiator = verlengde buis, 3de buis van links en rechts</li> <li>Aantal buizen:  <ul style="list-style-type: none"> <li>≤ 1440 mm: 2 voeten</li> <li>1620 mm - 3060 mm: 4 voeten</li> </ul> </li> <li>• Zijbevestiging: 20 cm</li> <li>* Gelieve bij bestelling <b>code -0006</b> aan te geven bij "Afwerking" (vaste voet/zijbevestiging in de prijs inbegrepen).</li> </ul>				



ACCESSOIRES	KLEUR	ART. NR.	€
<b>TV1 / TV2 / TH1 / TH2</b>			
<b>HANDDOEKBEUGEL</b>	CHROOM	118322200000099	<b>166</b>
 <ul style="list-style-type: none"> <li>• h = 22 mm; b = 670 mm; d = 85 mm; a = 60 mm</li> </ul>			
<b>TV1 / TV2 / TH1 / TH2</b>			
<b>KNOP O-RING</b>	CHROOM	118360100000099	<b>28</b>
 <ul style="list-style-type: none"> <li>• h = 22 mm; b = 22 mm; d = 42 mm</li> </ul>			
<b>TV1 / TV2 / TH1 / TH2</b>			
<b>KNOP BREDE GLEUF</b>	CHROOM	118340100000099	<b>28</b>
 <ul style="list-style-type: none"> <li>• h = 22 mm; b = 22 mm; d = 42 mm</li> </ul>			
<b>TV1 / TV2 / TH1 / TH2</b>			
<b>DROOG- EN STAPELREK SMAL</b>	CHROOM	118300800000099	<b>166</b>
 <ul style="list-style-type: none"> <li>• h = 22 mm; b = 385 mm; d = 163 mm; a = 30 mm</li> </ul>			
<b>TV1 / TV2 / TH1 / TH2</b>			
<b>DROOG- EN STAPELREK BREED</b>	CHROOM	118301100000099	<b>166</b>
 <ul style="list-style-type: none"> <li>• h = 22 mm; b = 530 mm; d = 163 mm; a = 30 mm</li> </ul>			

d = afstand voorkant accessoire tot voorkant radiator  
a = afstand accessoire tot radiator  
**uit voorraad leverbaar**

**TULIPA VERTICAAL: TV1 / TV2 (VOORRAAD)**

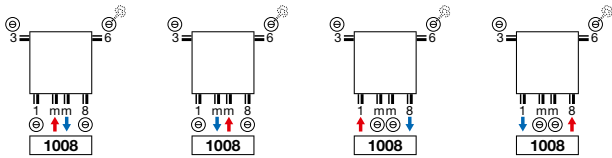

**TULIPA: TV1 / TV2 / TH1 / TH2 (NIET-VOORRAAD)**

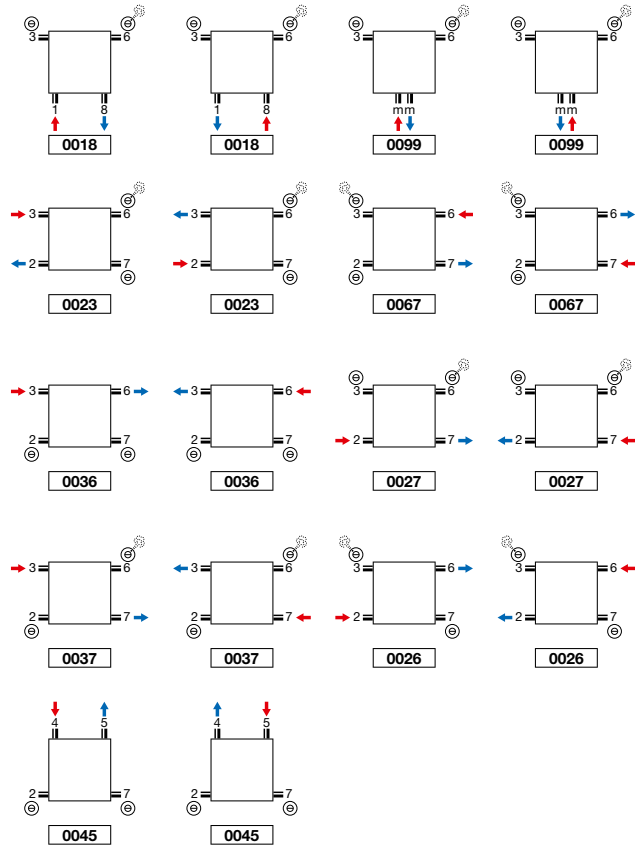

- Tulipa 6 en 8 buizen: aansluiting 1mm8, 18, 81 niet mogelijk

**Opmerking:** het aansluiten van de radiator kan enkel volgens de getoonde aansluiticonen. Voor elke andere aansluitwijze nemen wij geen verantwoordelijkheid.

TULIPA VERTICAAL (TV1, TV2)

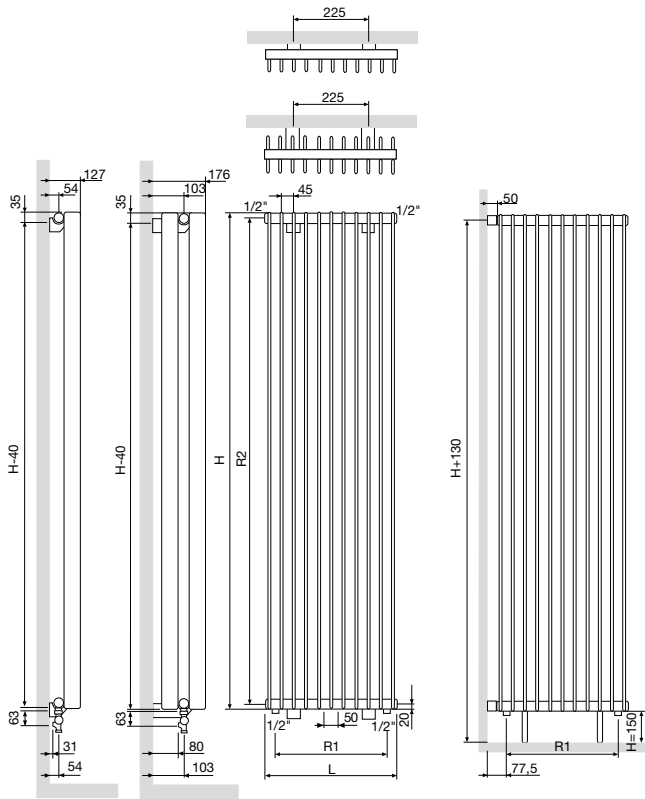

	TV1 / TV2											
Breedte (L)	270	360	450	540	630	720	810	900	990	1080	1170	1260
Hartafstand tussen de onderaansluitingen 18 (R1)	180	270	360	450	540	630	720	810	900	990	1080	1170
Hoogte (H)	1000	1200	1400	1600	1800	2000	2200	2400	2600	2800	3000	
Hartafstand tussen de zijansluitingen 23/67 (R2)	960	1160	1360	1560	1760	1960	2160	2360	2560	2760	2960	
Hartafstand tussen de ophangingen	H-40											

TULIPA HORIZONTAAL (TH1, TH2)

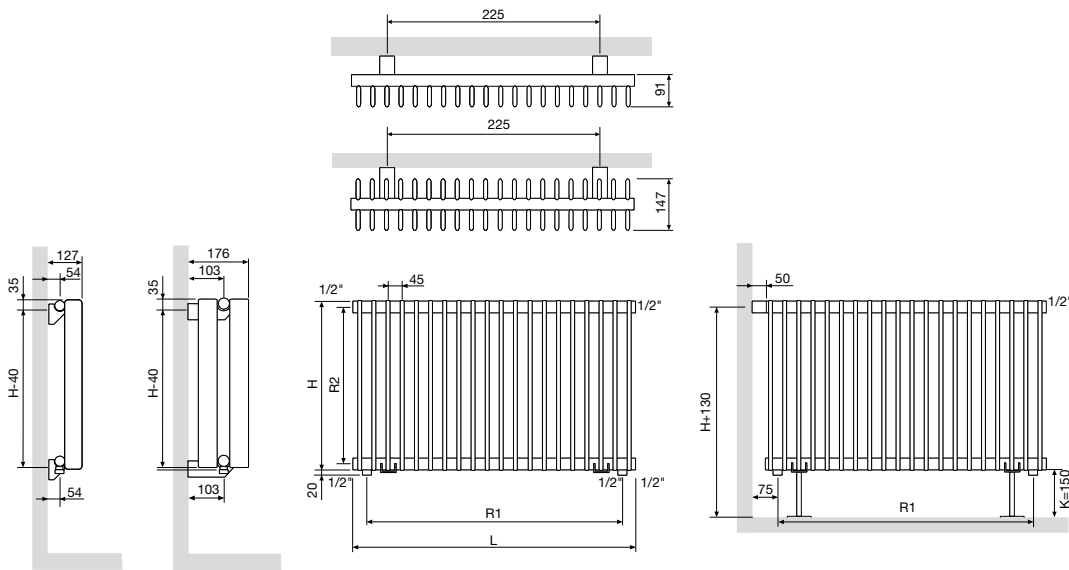

	TH1 / TH2																		
Breedte (L)	540	630	720	810	900	990	1080	1170	1260	1440	1620	1800	1980	2160	2340	2520	2700	2880	3060
Hartafstand tussen de onderaansluitingen 18 (R1)	450	540	630	720	810	900	990	1080	1170	1350	1530	1710	1890	2070	2250	2430	2610	2790	2970
Hoogte (H)	400	500	600	700	800	900													
Hartafstand tussen de zijansluitingen 23/67 (R2)	365	465	565	665	765	865													
Hartafstand tussen de ophangingen	H-40																		

#### TYPES

- Eén (VRV1-X) of twee rijen buizen (VRV2-X)

#### BUIZEN

- Verticaal, rond Ø 22 mm

#### COLLECTOREN

- Horizontaal, rond Ø 35 mm

#### KLEUREN

- Standaardkleur wit RAL 9016
- Uitgebreide kleurenkaart zie p. 16

#### BEVESTIGINGEN

- Muurbevestigingen standaard
- VRV1-X / VRV2-X ook verkrijgbaar als vrijstaande opstelling, zie p. 175

#### TECHNISCH

- Weerstandsgelast (onzichtbare lasnaden)
- KTL-grondlaag, poedercoating
- Standaardwerkdruk: 10 bar
- Maximale bedrijfstemperatuur: 110°C

#### ELEKTRISCH (zie hoofdstuk elektrische radiatoren)

- ✗ Zuiver elektrische radiator in de fabriek voorgevuld
- ✗ Gemengde radiator

#### TECHNISCHE TEKENINGEN

- Zie p. 177

#### AANSLUITING

- ✓ Eénpuntsaansluiting voor éénpijpsysteem (radiator speciaal te bestellen) (zie p. 301)
- ✓ Eénpuntsaansluiting voor tweepijpsysteem (radiator speciaal te bestellen) (zie p. 301)
- ✓ Tweepuntsaansluiting voor éénpijpsysteem (aansluiting via de middenaansluiting) (zie p. 300)
- ✓ Tweepuntsaansluiting voor tweepijpsysteem (standaard) (zie p. 300)
- ✗ Geïntegreerd ventiel

#### AANBEVOLEN AANSLUITING (0099)

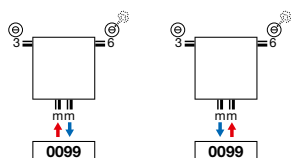

#### AANBEVOLEN VOOR BADKAMER IN OPTIE



handdoekbeugel (chrom)  
art. nr. 118322700000099  
prijs € 166

#### Andere aansluitmogelijkheden, zie p. 176



art. nr. 1182002000009016

prijs € 91

Koppelingen, zie p. 313



VRV1-X / VRV2-X



#### OVER VERONICA VERTICAAL

#### Alles in verhouding, alles in harmonie

Alles in proportie. Ook als het om klimaatregeling gaat. Met de Veronica ontwikkelde Vasco en designradiator die imponeert door zijn krachtig volume en charmeert door zijn pure elegantie en de fijne, ronde buizen. Hetzelfde geldt voor de verwarmingscapaciteit. De Veronica staat borg voor optimale prestaties, in eender welk interieur.

# VERONICA VERTICAAL (VRV1-X, VRV2-X)

## HOE VERONICA VERTICAAL BESTELLEN

Leveringstermijn 15 - 30 werkdagen  
(zonder transportduur)



VRV1-X

VRV2-X

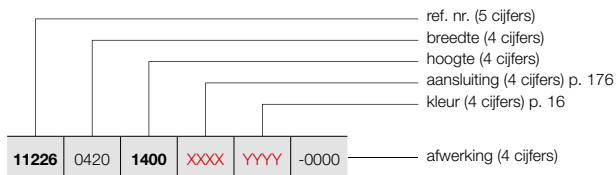

### VRIJSTAANDE OPSTELLING (VRV1-X, VRV2-X)

Zie p. 175 voor extra toebehoren.

BESTELCODE MAATWERK VERONICA VERTICAAL							TECHNISCHE GEGEVENS						STANDAARDKLEUR	ANDERE KLEUREN			
REF. NR.	0420	1400	XXXX	YYYY	-0000		buizen	breedte (L mm)	hoogte (H mm)	75/65/20 (Watt)	55/45/20 (Watt)	n-exp.	gewicht (kg)	inhoud (l)	el. weerst. (Watt)	prijs RAL 9016	prijs kleur
<b>REF. NR. VERONICA VERTICAAL VRV1-X : 11226</b>																	
11226	0420	1400	XXXX	YYYY	-0000		12	420	1400	753	386	1,31	12,24	5,64	-	281	323
		1600					12	420	1600	850	435	1,31	13,68	6,36	-	307	353
		1800					12	420	1800	947	485	1,31	15,12	7,20	-	333	383
		2000					12	420	2000	1043	542	1,28	16,68	7,92	-	359	413
		2200					12	420	2200	1139	592	1,28	18,36	8,64	-	385	443
11226	0492	1400	XXXX	YYYY	-0000		14	492	1400	878	450	1,31	14,28	6,58	-	313	360
		1600					14	492	1600	992	508	1,31	15,96	7,42	-	344	396
		1800					14	492	1800	1105	566	1,31	17,64	8,40	-	375	431
		2000					14	492	2000	1217	633	1,28	19,46	9,24	-	405	466
		2200					14	492	2200	1328	691	1,28	21,42	10,08	-	436	501
11226	0564	1400	XXXX	YYYY	-0000		16	564	1400	1004	514	1,31	16,32	7,52	-	346	398
		1600					16	564	1600	1134	581	1,31	18,24	8,48	-	381	438
		1800					16	564	1800	1263	647	1,31	20,16	9,60	-	416	478
		2000					16	564	2000	1391	723	1,28	22,24	10,56	-	450	518
		2200					16	564	2200	1518	789	1,28	24,48	11,52	-	485	558
11226	0636	1400	XXXX	YYYY	-0000		18	636	1400	1129	578	1,31	18,36	8,46	-	379	436
		1600					18	636	1600	1276	653	1,31	20,52	9,54	-	418	481
		1800					18	636	1800	1421	728	1,31	22,68	10,80	-	457	526
		2000					18	636	2000	1565	814	1,28	25,02	11,88	-	496	570
		2200					18	636	2200	1708	888	1,28	27,54	12,96	-	536	616
<b>REF. NR. VERONICA VERTICAAL VRV2-X : 11227</b>																	
11227	0420	1400	XXXX	YYYY	-0000		12	420	1400	1159	594	1,31	22,92	10,68	-	478	550
		1600					12	420	1600	1299	662	1,32	25,80	12,12	-	522	600
		1800					12	420	1800	1435	727	1,33	28,80	13,56	-	565	650
		2000					12	420	2000	1568	803	1,31	32,04	14,76	-	611	703
		2200					12	420	2200	1697	869	1,31	35,40	15,96	-	655	753
11227	0492	1400	XXXX	YYYY	-0000		14	492	1400	1352	692	1,31	26,74	12,46	-	533	613
		1600					14	492	1600	1516	772	1,32	30,10	14,14	-	585	673
		1800					14	492	1800	1675	849	1,33	33,60	15,82	-	638	734
		2000					14	492	2000	1829	937	1,31	37,38	17,22	-	688	791
		2200					14	492	2200	1980	1014	1,31	41,30	18,62	-	741	852
11227	0564	1400	XXXX	YYYY	-0000		16	564	1400	1546	792	1,31	30,56	14,24	-	588	676
		1600					16	564	1600	1732	882	1,32	34,40	16,16	-	648	745
		1800					16	564	1800	1914	970	1,33	38,40	18,08	-	708	814
		2000					16	564	2000	2091	1071	1,31	42,72	19,68	-	765	880
		2200					16	564	2200	2263	1159	1,31	47,20	21,28	-	825	949
11227	0636	1400	XXXX	YYYY	-0000		18	636	1400	1739	891	1,31	34,38	16,02	-	645	742
		1600					18	636	1600	1949	993	1,32	38,70	18,18	-	711	818
		1800					18	636	1800	2153	1091	1,33	43,20	20,34	-	778	895
		2000					18	636	2000	2352	1205	1,31	48,06	22,14	-	844	971
		2200					18	636	2200	2546	1304	1,31	53,10	23,94	-	911	1048

CE<sub>05</sub> conform EN442-1: radiatoren en convectoren

Voor de warmteafgifte van andere regimes, kijkt u op p. 308 (correctiefactoren)  
Prijzen in euro (excl. BTW)

ACCESSOIRES	KLEUR	ART. NR.	€
<b>VRIJSTAANDE OPSTELLING</b> 	<b>VRV1-X / VRV2-X</b>		
	RAL 9016	118100700009016	<b>62</b>
	KLEUR	11810070000xxxx	<b>71</b>

- Radiatoren in de kleur RAL 9016 en Pergamon krijgen 1 aparte zijbevestiging, 2 voeten (H=150 mm) en 2 rosetten in de betreffende kleur.
- Radiatoren in overige kleuren krijgen 1 aparte zijbevestiging, 2 voeten (H=150 mm) in de kleur van de radiator en 2 verchromde rosetten.

**VERONICA** ACCESSOIRES  
IN OPTIE

ACCESSOIRES	KLEUR	ART. NR.	€
<b>HANDDOEKBEUGEL</b> 	<b>VRV1-X / VRV2-X</b>		
	CHROOM	118322700000099	<b>166</b>

- h = 22 mm; b = 670 mm; d = 85 mm; a = 60 mm

d = afstand voorkant accessoire tot voorkant radiator  
a = afstand accessoire tot radiator  
**uit voorraad leverbaar**

VERONICA VERTICAAL: VRV1-X / VRV2-X

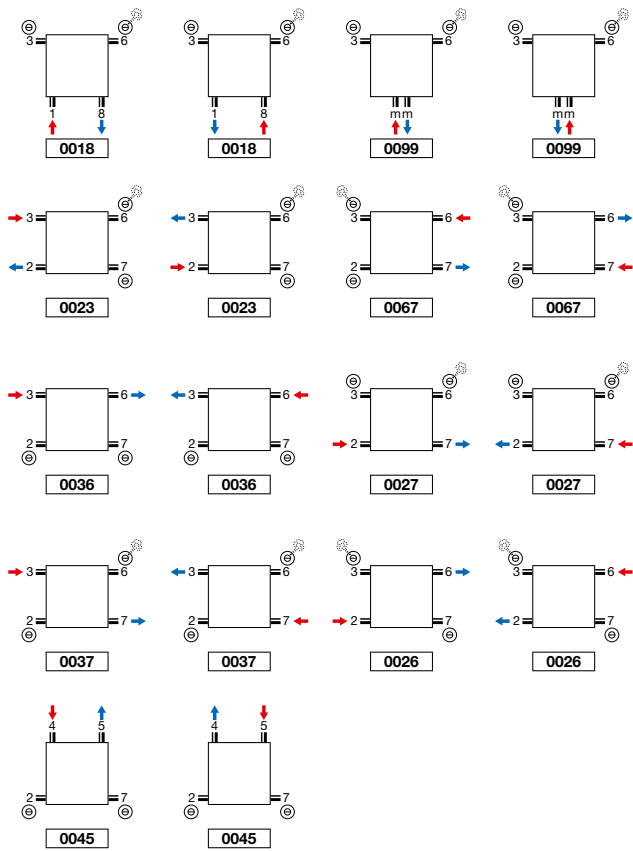

**Opmerking:** het aansluiten van de radiator kan enkel volgens de getoonde aansluiticonen. Voor elke andere aansluitwijze nemen wij geen verantwoordelijkheid.

VERONICA VERTICAAL (VRV1-X, VRV2-X)

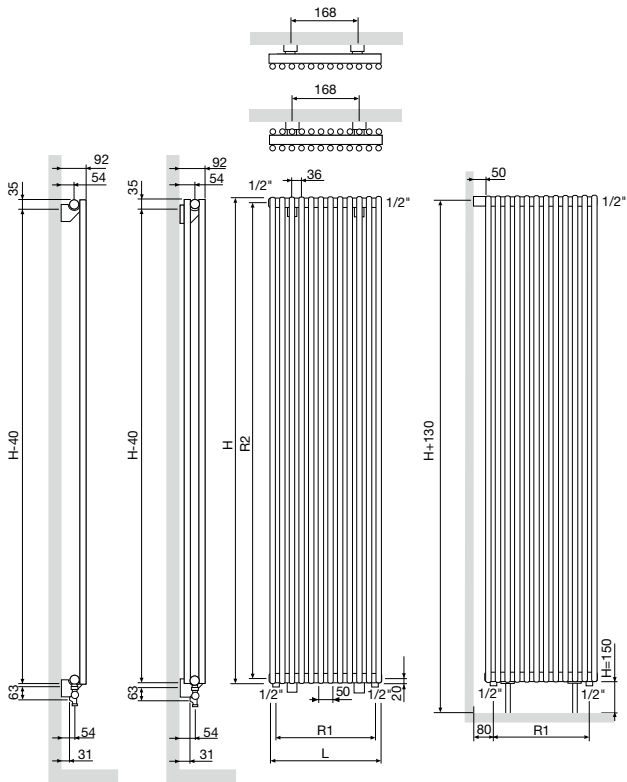

	VRV1-X / VRV2-X				
Aantal buizen	12	14	16	18	
Breedte (L)	420	492	564	636	
Hartafstand tussen de onderaansluitingen 18 (R1)	360	432	504	576	
Hoogte (H)	1400	1600	1800	2000	2200
Hartafstand tussen de zijaansluitingen 23/67 (R2)	1360	1560	1760	1960	2160
Hartafstand tussen de ophangingen	H-40				